

The

Wireless World

6^D

THE PRACTICAL RADIO & TELEVISION JOURNAL

Thursday, September 7th, 1939

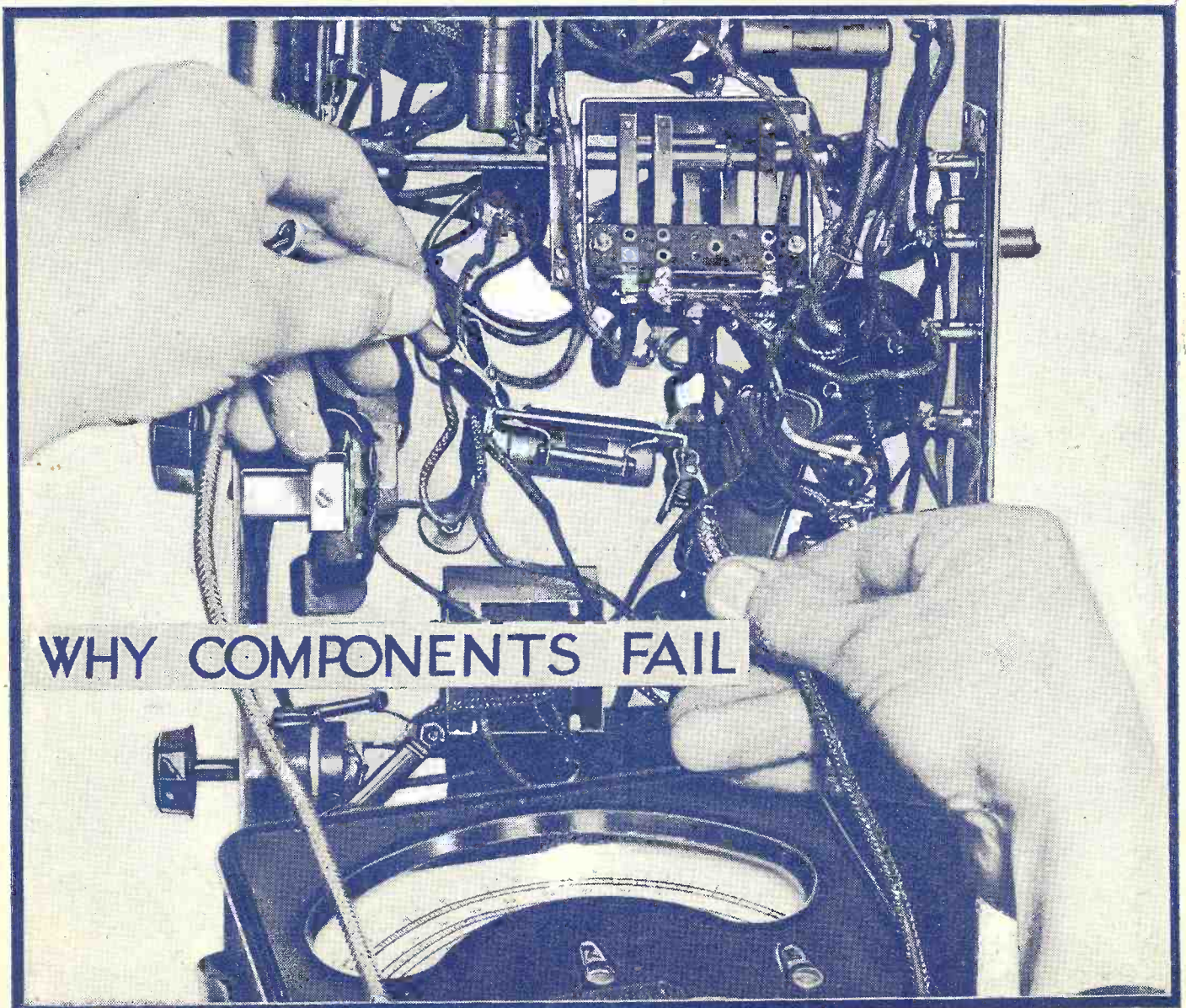

WHY COMPONENTS FAIL



SIX RANGES

0-.0005 Mfds.	.003-.005 Mfds.
.0005-.0015 Mfds.	.005-.01 Mfds.
.0015-.003 Mfds.	.01-0.1 Mfds.

The **"AVO" CAPACITY METER**
 A simple and accurate capacity meter, reading capacities directly from a calibrated dial. Six ranges; measurements can be made from a few mmfd. to 0.1 mfd. (100,000 mmfd.) correct to within an error of less than 1%. Measurements carried out by a resonance method, the unknown condenser being introduced into a tuned circuit coupled to a radio frequency oscillator. A meter gives visual indication of resonance; length of meter deflection gives a comparative measure of losses of condenser under test. **£23**

'AVO' Precision ELECTRICAL TESTING INSTRUMENTS

Read Trade Mark

The Universal **AVO MINOR**
 Electrical Measuring Instrument.

This compact precision moving-coil instrument covers all A.C. and D.C. testing. It has 22 ranges for measuring A.C. voltage, D.C. voltage, current and resistance. All readings are direct. No calculations. The high total resistance of the instrument—200,000 ohms—ensures accurate readings. Complete with instruction booklet, leads, interchangeable testing prods, £5. 10s. and crocodile clips **£5. 10s.**
Leather Carrying Case, 10/-



BRITISH MADE



16 Gns.
Model 7 Resistance Range Extension Unit (for measurements down to 1/100th ohm) 12/6
Also, the 40-range Universal AvoMeter 14 Gns.
The 22-range D.C. AvoMeter 9 Gns.
Leather Carrying Case - - 25/-

The **MODEL 7 46 Range Universal AVO METER**
 Electrical Measuring Instrument.

A compact multi-range A.C./D.C. meter, it has 46 ranges covering A.C. and D.C. amperes and volts, also resistance, capacity, audio-frequency power output, and decibels. No external shunts or series resistances required. The meter conforms with B.S. first grade accuracy requirements; has a 5in. mirror scale; is provided with automatic compensation for errors arising from variations in temperature; and is protected by an automatic cut-out against damage through overload.

All "AVO" Instruments are available on Deferred Terms.

Write for fully descriptive Leaflets.

Sole Proprietors and Manufacturers:—
THE AUTOMATIC COIL WINDER & ELECTRICAL EQUIPMENT CO., LTD.
 Winder House, Douglas Street, London, S.W.1.
 Phone: Victoria 3404-7.

WHEN DEPENDABILITY IN AN EMERGENCY IS A QUALITY THAT CANNOT BE OVER-RATED

— SPECIFY SOUND SALES

Sound Sales Amplifiers are recognised by all established experts to be second to none in compact design, engineering construction, performance and general utility. We have a special department detailed to concentrate on the survey and installation of A.R.P. Communication Systems under the direction of ex-service men who are able to appreciate the conditions and thus offer specialised technical advice. The illustration shows a typical Sound Sales self-contained Amplifier.

We shall be pleased to send you further details of this model together with a unique but inexpensive multi-channel system which can maintain communications under the most arduous conditions.

May we send you our latest Catalogue and Technical Manual - - - - - Price **6d.**



All **SOUND SALES** products can be obtained on **DEFERRED TERMS** from the **LONDON RADIO SUPPLY COMPANY, 11, Oat Lane, Noble Street, E.C. 2**

SOUND SALES LTD.
MARLBOROUGH ROAD, UPPER HOLLOWAY, LONDON, N.19
 Telephone: **ARCHway 1661-2-3.**
 CONTRACTORS TO THE AIR MINISTRY, G.P.O., ETC.

Mention of "The Wireless World," when writing to advertisers, will ensure prompt attention.

The Wireless World

THE PRACTICAL RADIO JOURNAL
29th Year of Publication

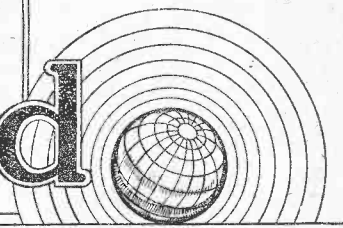
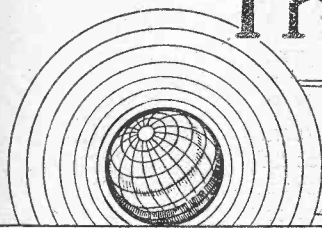

No. 1045

THURSDAY, SEPTEMBER 7TH, 1939

VOL. XLV No. 10

Proprietors : ILIFFE & SONS LTD.

Editor :
HUGH S. POCOCK.

Editorial,
Advertising and Publishing Offices :
DORSET HOUSE, STAMFORD STREET,
LONDON, S.E.1.

Telephone: Waterloo 3333 (50 lines).
Telegrams: "Ethaworld, Sedist, London."

COVENTRY: 8-10, Corporation Street.
Telegrams: "Autocar, Coventry." Telephone: 5210 Coventry.

BIRMINGHAM:
Guildhall Buildings, Navigation Street, 2.
Telegrams: "Autopress, Birmingham." Telephone: 2971 Midland (5 lines).

MANCHESTER: 260, Deansgate, 3.
Telegrams: "Iliffe, Manchester." Telephone: Blackfriars 4412 (4 lines).

GLASGOW: 26B, Renfield Street, C.2.
Telegrams: "Iliffe, Glasgow." Telephone: Central 4857.

PUBLISHED WEEKLY. ENTERED AS SECOND CLASS MATTER AT NEW YORK, N.Y.

Subscription Rates :

Home and Canada, £1 10s. 4d.; other countries, £1 12s. 6d. per annum.

As many of the circuits and apparatus described in these pages are covered by patents, readers are advised, before making use of them, to satisfy themselves that they would not be infringing patents.

CONTENTS

	Page
Editorial Comment	227
Why Components Fail	228
On the Short Waves	230
Problem Corner	230
Impressions of Olympia : "Dial-list" Looks Back at the Show ..	231
Cathode-Ray Photography	233
Mechanics of Receiver Design	235
Five-metre DX	237
American Progress—And Ours	238
Random radiations	240
News of the Week	241
Unbiased	242
Olympia Conventions : Technical Meetings at the Show	243
Voltage-dropping Resistances	245
Recent Inventions	246

EDITORIAL COMMENT

Wireless and War

Services to the Nation

THOSE of us who have spent our working lives in the service of wireless must often have taken encouragement from the thought that the part we have played, humble though it may be, has contributed something towards the good of humanity. The record of wireless is indeed nothing to be ashamed of: we think of the thousands of lives saved from the perils of the sea by wireless telegraphy and of the interest and widening of outlook brought to millions by broadcasting. But it has long been a cause for regret to many of us that the self-evident potentialities of broadcasting in the cause of peace have been exploited with such poor success.

"Nation shall speak peace unto nation" was an inspiring motto for those responsible for British broadcasting, and it was one which they conscientiously strove to justify. That it has so far failed to achieve results does not imply that any blame is to be apportioned, and, even if it were, this is no time for recriminations.

International Broadcasting

Although wireless may not have succeeded in this respect, it has performed a wonderful service to everyone during the dark days of suspense. Anxiety and uncertainty has been relieved, and the extraordinary calmness of the British nation must surely be due in no small measure to the thoroughness of the B.B.C.'s news service. Other organisations that deserve the thanks of the world are the great American broadcasting networks. Considering their position as neutrals and making allowance for the Transatlantic tendency towards dramatisation of news, the crisis

has been handled with admirable restraint. So far as broadcasts that we ourselves have heard or seen reported are concerned, nothing has been done to exacerbate the European situation; on the contrary, obviously genuine efforts have been made to play the part of peacemaker. The broadcasting of news bulletins from America in the languages of all potential belligerents has probably done good. Coming from a neutral country, such messages probably carry more weight than if they emanated from a more directly interested and inspired source.

We must not delude ourselves into thinking that the kind of international short-wave broadcast to which we have just referred reaches a very wide audience. The number of efficient short-wave sets in use is still small, though the better types are now more readily available than hitherto. We can foresee a wide market for them when more normal conditions return. As a contributor says elsewhere in this issue, there is nothing like a good wireless set for collecting news; it gives its owner the feeling of being in intimate touch with things as they happen, and he becomes something more than a mere spectator, remote and aloof from actualities.

Whatever the days ahead may have in store for us, there is one thing that we can face with the most serene confidence. The wireless service, though young in years, has already established a tradition of steadfast devotion to duty on the part of its personnel of which we are all justifiably proud. Maintenance at extreme efficiency of all forms of wireless communication is now vital to the successful prosecution of the war; the various branches of the service may meet with difficulties that none of us can yet foresee, but, whatever these difficulties may be, communication will be maintained.

Why Components Fail

RELATIVE SUSCEPTIBILITY TO BREAKDOWN

THERE is no substitute for the close inductive reasoning of which every serious radio man must be capable—especially if he has much to do with the tracing of faults in modern receivers. But out of experience comes an intuitive knowledge of where common troubles are likely to lie, and this enables the skilled man to short-circuit some of the laborious fundamental testing and go straight to the component that is the probable cause of the trouble. A knowledge of the primary causes of breakdown in generally used components is a useful aid to such speedy diagnosis.

Speaking very generally, it may be said that those components combining mechanical movement with electrical function are, on the whole, liable to develop unsatisfactory behaviour, if not complete failure, before the rest. It is probable, as a matter of fact, that such components only seem to develop faults before the rest because their physical movement reveals impending defects. In other components the process of deterioration is difficult to detect before the stage of complete failure is reached. Placing them roughly in order of liability to give trouble, then, volume controls of the high-resistance potentiometer type are notoriously liable to give rise to noises; switches seem to come next, then loud-speaker speech coils. In the class of fixed components, condensers seem to fail before resistors, and coils, including the windings of chokes and transformers, last of all. Valves are in a class by themselves. The nature of the defects to which these various components are liable will now be discussed.

In these days of AVC for preventing excessive amplification of signals in the RF stages, output level is usually controlled by high-resistance potentiometers connected across two points of AF difference of potential, such as the secondaries of transformers or the load circuits of diode detectors. In these positions they seldom handle much power and the causes of their failure lie more in the inherent shortcomings of their materials and construction than in the functions they have to perform.

Potentiometers usually consist of a thin layer of composition resistive element fixed to an insulating base, and the moving contact is made by a squash-plate. The expansion with heat of the element itself may not be the same as that of the base to which it is fixed, and the frequent and considerable temperature changes that occur in a mains-driven receiver cause the element to crack. This may happen at some part of the ele-

By W. H. CAZALY, Grad.I.W.T.

ment that is not normally used, either the extreme loud or low volume ends, and until the crack is complete it may pass unnoticed. Although the squash-plate is a far better method of making moving

A KNOWLEDGE of the liability to breakdown of the various components of a receiver often saves waste of time in searching for a fault; the present article discusses this matter and also describes the usual causes of failure.

contact than a rubbing slider (which is liable to break up the smooth, hard surface of the element) it does not entirely overcome a very common difficulty which is known as "hop-off resistance." As the contact passes from the end contact to the body of the element, a sudden change of resistance in that arm of the potentiometer from almost zero to, perhaps, many thousands of ohms, takes place, and the volume, instead of decreasing gradually, does so abruptly. Again, since contact at the ends of the element is often made by painting with colloidal

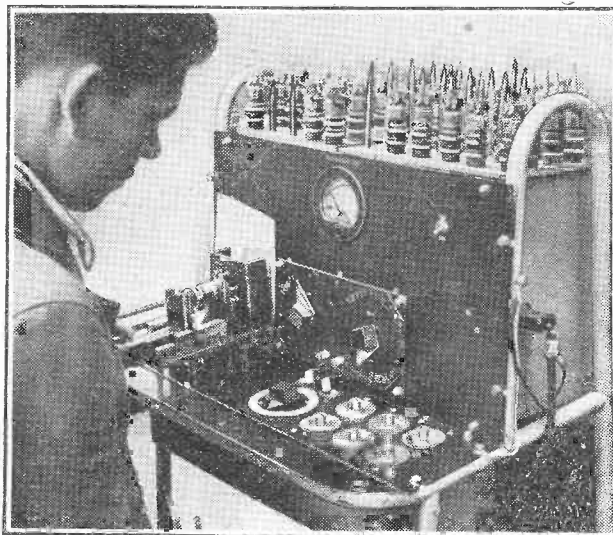

Gourtesy Pye, Ltd.
Prevention is better than cure: testing and matching of components is an important part of factory routine.

copper—finely divided copper or bronze particles suspended in liquid—this thin layer of copper paint may crack away

from the element, and when the squash plate impinges on this cracked contact the resultant noises are only too familiar.

Switches suffer from the effects of either dirt or oxidation. Rubbing contacts usually avoid these effects, but if the insulating material over which the rubbing contacts pass between the fixed contacts is soft, or itself likely to deteriorate with age through surface oxidation—ebonite is a frequent offender in this respect—it forms a layer on the rubbing contact. This can be removed with *very* fine abrasive paper. Pressure contacts in the better class switches are coated with some non-oxidising metal, and, as this is usually very thin, it should not be cleaned with abrasive; petrol, or even "penetrating oil," if afterwards removed, is best. The on-off switches in mains-driven receivers should, if of good quality, stand up to some 20,000 operations on full load of about 2 amps at 250 volts. Their failure is usually mechanical—the speed of opening the contacts falls and gives rise to arcing.

Speech Coil Defects

Considering the hard work they do, speech coils show a reliability that does credit to the immense amount of trial and research preceding their manufacture. Apart from obvious troubles due to incorrect centring and the like, they are liable to a loosening of the wire on the former, owing to the unequal expansion with heat of wire and former. This causes a shrill buzz, often only on certain frequencies, and the defect is usually not discernible when the coil is inspected cold. Coating the ends of the speech coil with cellulose or bake-lite cement is always a wise precaution if nothing else is obviously wrong.

Electrolytic condensers are essentially electro-chemical devices, and their behaviour can therefore be upset both during the forming process in manufacture and in subsequent use by minute chemical impurities in either the electrolyte or the metal of the electrodes, especially the positive element, which is usually aluminium. The action of chemical impurity is cumulative, so that even if a film of oxide formed during manufacture on the positive aluminium is sufficiently continuous and thick to enable the condenser to pass ordinary tests, in subsequent use further electrolytic action will take place due to the impurity and result in corrosion of

the electrode and the destruction of the oxide layer. Once a leakage path is set up by this process, heat generated at that

Why Components Fail—

spot by the passage of current makes matters worse.

An electrolytic condenser has a limited "shelf-life": if not used, the oxide film slowly dissolves, and if, on again putting the condenser into use, the full rated voltage is applied, so much current passes that heat is generated and the oxide layer cannot re-form. Hence, a long disused electrolytic condenser should be gradually reformed by the application of low initial voltage which can be steadily increased until the rated value is reached. Loss of capacity is due either to drying up of the electrolyte or to the oxidation of the aluminium where it is attached to the external lead—at which point soldering is almost impossible. Loss of capacity also occurs as a natural result of the passage of the small leakage current that is inevitable with electrolytic condensers: this current tends to exhaust the active chemicals of the electrolyte by continued electrolysis, or even to build up the oxide layer faster than it is dissolved by the electrolyte, making it a thicker dielectric.

Superimposed on the steady DC voltage, at which the condenser is designed to operate, there is very often an AC component—such as the ripple that electrolytic condensers are required to eliminate in smoothing circuits. This ripple voltage drives a current through the condenser which may be concentrated at spots where the oxide film is thinner and so give rise to localised heat. For this reason the breakdown of some component in another part of the circuit which tends to increase the ripple voltage—for example, a partial short-circuit of the HT supply so that excessive current passes through the smoothing choke, reducing its inductance—may cause an electrolytic condenser to break down. Although normally the temperatures reached in a mains driven receiver keeps the atmosphere round the electrolytic condensers dry, cases may arise in which the condenser can absorb moisture, which may cause internal sparking, with consequent charring of the impregnated cotton spacing between the electrodes.

Paper—dielectric Condensers

The larger solid dielectric condensers usually have aluminium foil plates, and the impossibility of attaching these to external leads by soldering gives rise to poor contact at these points and apparent loss of capacity. Short-circuits in such condensers, without the application of excessive voltage or the passage of AC, seem usually to be due to impurities in the paper or the wax used as the dielectric; leakage currents initiated by such defects give rise to localised heat and charring of the wax and paper.

Fixed resistors deserve a book to them-

selves. They are, as a matter of fact, a makeshift forced on us by the failure of Nature to provide us with a good choice of substances having specific resistance between that of the fairly good conductors and that of the insulators. Those that have such intermediate resistivity, such as germanium, are either rare and expensive or chemically and physically unsuitable. Moreover, it seems to be impossible to predict from its chemical or physical structure what the electrical behaviour of any compound is going to be, and knowledge in this direction is largely empirical. Hence, in order to obtain high resistivity with reasonable bulk and cost, resort is had to mixtures of a good conductor, such as powdered graphite, with insulating binders such as resins and clays, the mixture being subjected to various processes to render it durable. This is the modern method, and, fortunately, the day of the simple graphitic rubbing or painting on a

ends: usually this is done by a metal cap or wrapping of wire, and the application of a hot soldering iron may cause the contact to separate from the element or become loose. Finally, there is a curious electrostatic effect in composition resistors used in high voltage circuits. "Like charges repel . . ." and particles of graphite in the element similarly charged at high voltage may repel each other unless they are very firmly embedded in the binder. This causes the resistance to "go high," and was one of the difficulties that high-voltage television experimenters encountered. With a steep potential gradient through the resistor, too, internal sparking may occur, giving rise to crackles and intense local heat.

LF Transformers and Chokes

Now let us consider coils. Multi-turn windings are not used in modern receivers nearly as much as in early types, and to-day are found only in the form of mains and output transformers. Hence they are not prominent trouble-makers: for that matter, well-constructed transformers and chokes never did give much trouble unless grossly overrun.

Litz wire RF coils can still give rise to loss of amplification if soldered connections are made to their ends, but by fusing the strands together in a small hot gas flame and so welding them to a thicker lead, even this difficulty has been largely overcome.

Failures in iron-cored RF coils can be traced to either the penetration of moisture or to bad winding processes, and

the latter is a negligible factor in the products of reputable firms charging economic prices for their goods. Mass-production winding machines are extremely expensive, and this must be taken into consideration when considering the prices of multi-turn coils: they cannot be efficiently produced at very low cost. Moisture in the windings causes corrosion by electrolysis and the generation of localised heat by leakage currents. Bad construction has the following effects:—

Overrun turns: superimposed layers press hard on the overrun turns to cause the wire to bite through enamel insulation and give rise to a short-circuited turn which, by induction, has excessive current generated in it, causing heat and further deterioration of insulation.

Loose winding: in circuits carrying power, insecure windings may vibrate just as the speech coil of a speaker, and this vibration, though of small amplitude, may rub off the insulating varnish, causing short-circuited turns. This is a very common cause of failure in mains input transformers.

Cheap and nasty varnish: this may contain acid impurities that corrode the copper, absorb moisture, and becomes

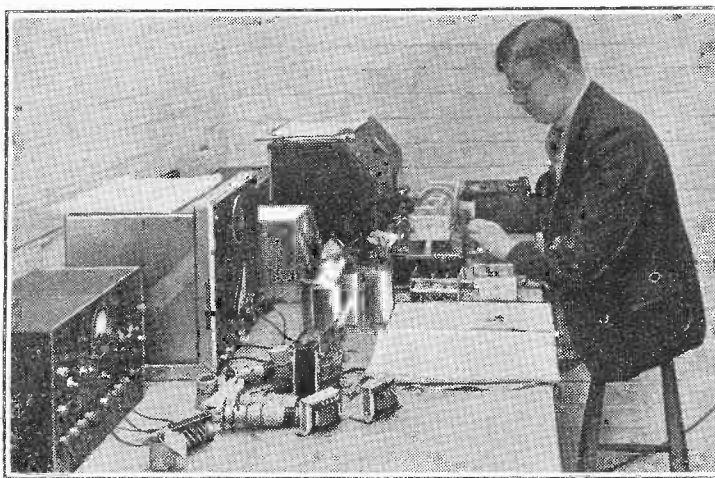

Courtesy Murphy Radio, Ltd.
At work in the Reject Analysis Department of a receiver factory. Here defects are investigated with a view to preventing their recurrence.

stick of pipe-clay has gone: good modern resistors do not now give much trouble if they are not overloaded.

But certain shortcomings in composition resistors remain. For one thing, such mixtures are not very successful as elements in variable resistances, as has been indicated when discussing potentiometer volume controls, for which the element must be thin in order that the moving member can make some approach to contact with the main body of the element instead of merely with its surface. Moreover, certain heat and pressure treatments become difficult when the element must be annular in shape and fixed to an insulating base; thus something in the nature of a mixture of graphite with a gummy self-drying binder must be used. Since the high resistivity of the element is in this case obtained merely by the attenuation of the conducting paths through the body of the resistor, it is difficult for internally generated heat to reach the surface and be dissipated by radiation. Hence composition resistors cannot handle much power without the heat causing changes in the nature of the binder.

Then there is the difficulty of making effective contact with the element at the

Why Components Fail—

brittle and easily cracked after a comparatively short period of use. The varnish will also have been put on unevenly, so that some parts of the wire are insufficiently insulated.

Poor quality flux for soldering fine wire to thicker leads is another common cause of breakdown. The traces of acid left give rise to corrosive electrolysis in use.

The cause of failure in valves depend essentially on construction. Of the purely electrical causes of failure, probably the commonest is the overheating of the filament or cathode. In mains valves, the cathode heats unevenly, so that the full voltages are applied to the HT electrodes while parts of the cathode are still comparatively cool. This gives rise to loss of emission at these parts, since the emissive material on the surface is stripped by the

high voltages. Moreover, the high voltages impart such velocity to the electrons that if there is the slightest trace of residual gas, such as occluded gas or that entering by an ultra-microscopic crack at the sealing of the leads into the glass, ionisation takes place and the cathode surface is disintegrated by bombardment with positive ions. The changes of temperature undergone by the cathodes of mains valves causes the insulation to crack sooner or later, when leakage occurs between the heater and the cathode surface. In battery valves, especially the output valve with its thick filament and high anode voltage, the filament is destroyed by ionic bombardment. In fact, it may be said that the strain put on valve cathodes at the times of switching receivers on and off is responsible for their deterioration more than many hours of steady and continuous use.

On the Short Waves

PREVAILING CONDITIONS ON THE VARIOUS BANDS

AFTER a spell of poor conditions around August 22nd, short-wave conditions improved considerably and at the moment of writing are up to the best sunspot maximum standards. Early on the evening of August 30th, the presumably rather low-angled radiation from the American stations W2XE and WNBI in the 17 Mc/s band was on rather *too low* a frequency for the conditions then prevailing. At 10 p.m. G.M.T. on August 29th, the Rio telegraph transmitter PPX on 20 Mc/s approx. was still an R9 signal.

These good conditions are undoubtedly connected with the presence on the sun's surface of a sunspot covering 800 millionths of its disc during the period August 26th-September 7th. Associated with it was a bright chromosphere eruption of magnitude 3 and August 29th from 08.51 to 10.10 G.M.T.

One effect of these excellent propagation conditions during the "war of nerves" period must not be overlooked, and this is that the B.B.C.'s Daventry transmitters GSE on 11.86 Mc/s and GRX on 9.60 Mc/s during the daytime and GRX and GSA on 6.05 Mc/s during the evening must have been particularly well received in Europe, if not throughout the world. Judging by the signal strength of GSA in London recently, special aerials are probably being employed in connection with the two transmitters regularly employed on this European Service.

To revert to the performance of W2XE and WNBI, one notes that W2XE's new channel is quite clear of interference, and is a big improvement on the old shared channel with DJE, both W2XE and WNBI have been excellent, and have "covered the European crisis" from many angles—especially W2XE.

W2XE's programme during the late evening and early morning of August 29th-30th gives a good idea of how thoroughly European events were handled.

(1) Talk by C.B.S. representative in Paris.

(2) Talk by H. G. Wells and the C.B.S. representative in London.

(3) Talk by C.B.S. representative in Berlin.

(4) Talk by Mr. Douglas Reed, late of London *Times*.

(5) Talk by Dr. Kaltenborn, of C.B.S., from London.

(6) Talk by Y. Masyryk—Dr. Masyryk's son—from London.

(7) Final summing up by Dr. Kaltenborn.

It should be stated that W2XE closes down at 10.00 p.m. G.M.T. on 17 Mc/s and reopens at 10.30 p.m. G.M.T. on 11.83 Mc/s. This latter frequency is also well received, especially after midnight.

Although the American short-wave bands have been dominated completely by W2XE and WNBI, good signals have also been intercepted from WGEA on 15.33 Mc/s (19.56 m. formerly W2XAD) and news from W1XAL on 11.79 Mc/s has also been readable round 11 p.m. in spite of a high level of atmospherics on occasions.

Although the notes above indicate that there has been during the past week at least a temporary return to almost sunspot maximum conditions, it should be borne in mind that the tendency from now onwards will be for the optimum frequencies to get lower and lower and working waves to be longer for any given path and time.

The following quotation is taken from a paper read by D. R. Goddard, of R.C.A. recently, "The British afternoon (television transmissions on 41.5 and 45 Mc/s) programmes between 9.30 a.m. and 11.30 a.m. New York time, could be received at times during certain winter months with some clarity. In the past few years, the latest date for which reception is possible has been steadily receding from March through February to January, and it seems probable that next winter (as the sunspot approaches) no reception at Riverhead of these signals will be possible after December 31st."

With this disappearance of the 7-metre signals we may also expect to see the com-

Henry Farrad's

PROBLEM CORNER

No. 36.—Mysterious Disappearing Trick

An extract from Henry Farrad's correspondence, published to give readers an opportunity of testing their own powers of deduction:—

Rose Cottage,
Nitting Sockbury,
Worcs.

My Dear Henry,

You will be interested to know I have gone in for a new wireless! Well, it was getting a bit *passé*, if I may say so; and then when that interesting man spoke some time ago—Mr. Voltson Volt, wasn't it?—and made such queer noises, he quite convinced me that it was time to get a new one. One thing I particularly remembered that he said was if you wanted to get the best results from *all* stations you had to get a set with *Variable Selectivity*, so I made a special point of this when I went to buy mine.

It was a bit rash, I suppose, getting one without asking your advice first, Henry; but it does bring in a wonderful lot of stations when you turn the knob only quite a little way round. I cannot understand what they all say, except that some of them seem very angry. Most of them come in only one at a time, which I am afraid they *never* did on the old wireless! But there is one thing that seems rather queer, and I wonder if you can explain it. The book says that if you want to get the best tone you should have the variable selectivity knob fully to the right; then if you get other stations interfering you turn it to the left until they disappear. Well, I have tried this; and instead of the interfering station disappearing it was the one I wanted that disappeared! Wasn't that a strange thing?

Yours very sincerely,

Jane Stoughton.

Why does the variable selectivity behave in this way, and how can it be put right?
Solution on p. 232.

plete disappearance of amateur 5-metre signals across the Atlantic since all the recorded cases of transatlantic transmission appear to have been via the normal F-layer mechanism, as distinct from the U.S. lower atmosphere transcontinental phenomena of last year. Amateur communication on 10 metres (28 Mc/s) will also suffer to some extent, but 28 Mc/s conditions during the last sunspot minimum showed a peculiar habit of becoming quite good when the sun's face was completely devoid of spots. The reason for this anomaly is not clearly understood and will probably be the subject of further investigation in 1944 or thereabouts. It is just possible that the somewhat higher frequency television transmissions may behave in a similar way, but more erratically.

In conclusion, one notes that W2XE on 17 Mc/s is at the moment giving the latest news summaries in German, Polish, French and Italian, at 9 p.m. G.M.T. The inclusion of Polish is noteworthy and constitutes a precedent.

"ETHACOMBER."

Impressions of Olympia

"DIALLIST" LOOKS BACK AT THE SHOW

HAVING read that there was to be an Export Section at Radiolympia, I saw in my mind's eye a cluster of smallish stands—small because they would display only selected products—presided over by bronzed men well versed in what is needed in the way of radio receivers in the far countries of the Empire, and surrounded by other bronzed men, eager to see the receivers designed for their special requirements. The Export Section, I decided, would contain things of special interest to readers of *The Wireless World*: for the set that will receive Daventry in Canada or Australia or India or South Africa should also be just the thing for receiving Canada or Australia or India or South Africa if used in this country.

Hence, when I had made the first rather rapid preliminary tour that is my wont, I asked a commissionaire if he could direct me to the Export Section, which I hadn't so far observed.

"Couldn't say, sir," he replied; "perhaps this other commissionaire knows. George, where's the Export Section?" But George didn't know. Nor did Charlie when hailed by George, or Bill when Charlie applied to him.

However, I espied the stand of the Department of Overseas Trade and felt sure that they would put me right. They did. If I would but turn about in their doorway where I was standing, there would be the Export Section before my eyes.

It was rather a blow to find that it consisted of a single large stand, at the back of which were a number of show cases. In these were receivers and components; and notices referred one to the main stands of the firms that produced them. I suppose that really it wasn't a bad idea, for you'd only to jot down the numbers of these stands to know where the oversea goods were. But I would have liked to see my cluster of stands, my bronzed men demonstrating and buying . . .

And there was plenty at Radiolympia to have made a full-dress Export Section, or a Long-distance Section—or both. You found that when you came to go round the stands and to examine their wares in detail. I don't know how many sets there were, for instance, in which there were two or more short-wave ranges instead of one, but there were certainly a good few.

Short-wave Sets

Some time ago I wrote that the tuning of the "all-wave" receiver with a single short-wave range and no kind of band-spreading arrangements was apt to demand more patience than its owner might care to devote to searches for stations on wave-bands such as the 16-metre, the 19-metre and the 25-metre. There are welcome signs that designers have realised that if they

want short-wave reception to be popular they must make it as easy as the price of the set will allow.

One receiver has gone the whole hog. It covers only the 13-, 16-, 19-, 25-, 31- and 49-metre bands and none of the intervening wavelengths. But it devotes a full-scale sweep to each of these six bands; and what is more it bears the actual names of over 100 short-wave stations, whose exact setting are marked on the scales.

In a word, it aims at making the reception, not only of WGEA, WCAI, XGOY and other strongly received short-wave stations, but also of dozens of the smaller fry as easy as that of European medium-

the markets of India and other countries, where wavelengths of that order are authorised for the internal broadcasting services. In this country such a range has its uses, for it takes in two amateur bands and yacht telephony.

Some time ago numerous readers corresponded with me on the subject of really universal sets: sets that would work equally happily on AC mains, DC mains or batteries. There was a most ingenious portable on these lines at the show. The "working" valves are of the battery low-voltage low-current filament type. Their filaments are arranged in parallel when the batteries are in use, but in series for mains heating. The dry batteries used are contained in one and the same cardboard case, and both LT and HT connections to them are made by means of a 4-pin plug and socket. Grid biasing is automatic.

One striking demonstration given to me by the designer was to insert the mains plug into its socket and switch on. The set came to life instantly, the batteries doing

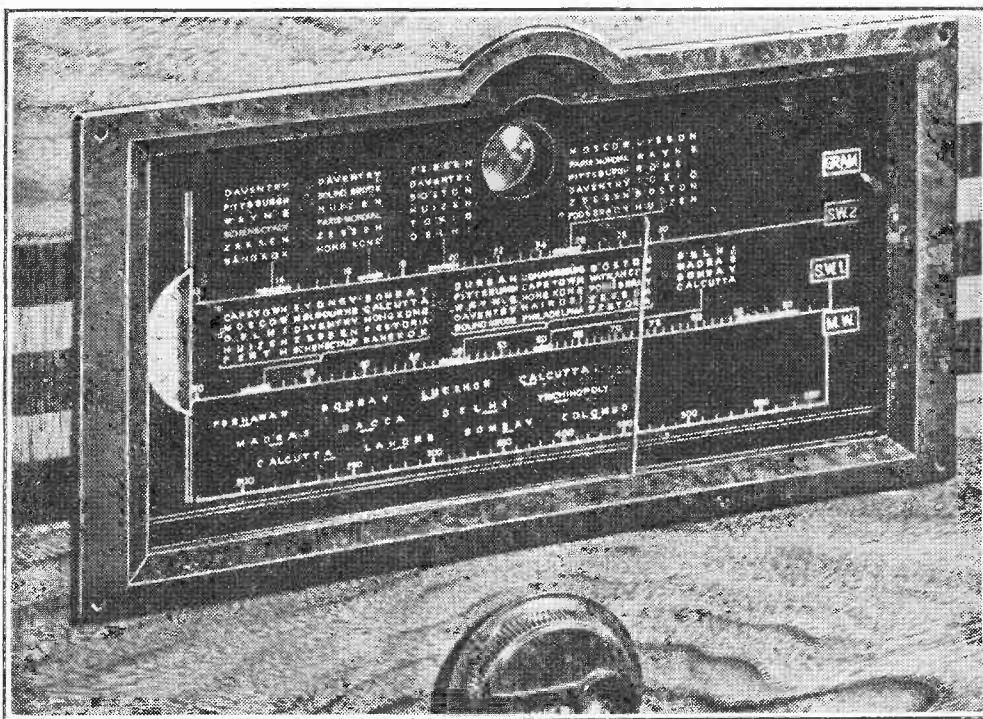

An Export Section exhibit. The tuning scale on the Marconiphone Model 808 universal six-valve superheterodyne is calibrated with the names of 12 Indian stations on the medium-wave band which covers 200-580 metres. The shorter wavelengths are covered in two ranges 13-30 and 30-90 metres. It is adjustable for any mains voltage between 105-255. Tuning is made easy by the incorporation of the Thaumoscope visual tuning indicator.

wave stations. That is indeed a laudable effort, and I look forward very much to trying one of these sets a little later on.

I was much attracted by the ingenious methods used by other designers. Some employed band-spreading of one kind or another; others pinned their faith to bigger and more clearly marked dials with finer pointers than in the models of yester-year; others, again, were waging war against second-channel "images" and whistles by the use of signal-frequency stages.

All of the "all-wave" models shown by one firm had a range of from 50-150 metres. These, I take it, are made with an eye to

duty until the rectifier had warmed up to a certain temperature. When that was reached, there was a slight click: by means of a relay the batteries had been cut out and current from the mains cut in. If the mains current was switched off, the relay immediately brought the batteries into action again.

I'm not sure that that principle isn't worth adapting to sets other than portables. Is there anything more annoying than when you suddenly realise that some item you specially want has just begun, switch on and have to wait what seems hours for the heaters to warm up?

Impressions of Olympia—

I don't know if I was specially lucky, but I seldom had any difficulty in finding at the stands I visited someone who would deal with technical questions. In past years one has too often found, on returning hopefully at intervals to a stand where there was something of particular interest, that the only technical man provided appeared to start on tea as soon as he had finished his lunch and on dinner the instant his teacup was empty.

Makers have realised that what the great public is yearning for above all things in their receivers is reliability. At stand after stand I was told of the steps that had been taken to ensure it, and of the amazingly complex tests to which sets are subjected before they leave the factory. The lessons of the past have been taken to heart, and I do think from what I saw of the insides of sets and of the components therein that real progress has been made in this respect.

Another thing that impressed me was the stress laid by many firms on the quality of the reproduction given by their better models. And, listening to the questions asked by Mr. and Mrs. Everylistener, I found something of a change there also. The first enquiry always used to be: "Will it bring in every station in Europe?" or "Will it get America?" This year I heard many lead off with questions about the reproduction of the local stations' programmes, absence of hiss, hum, other hateful background noises, and so on.

"The Services' stands were of considerable interest." This portable ground station, which was among the interesting apparatus to be seen on the R.A.F. stand, consists of the transmitter and receiver as used in a 'plane. Complete with message pad, key and 'phones, they are fitted into a metal cabinet the front of which is covered by a drop sheet.

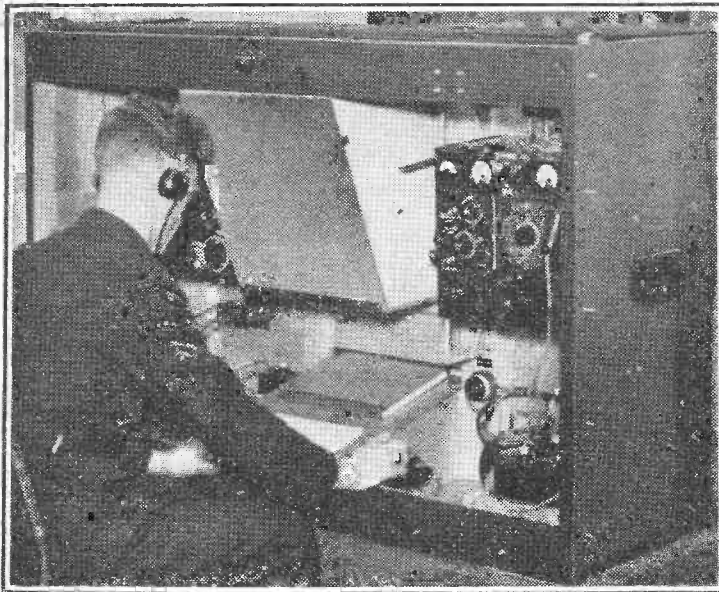

Radiolympia 1939 was certainly the most stunt-free exhibition that I can remember. And that, I feel, is a very good sign. Manufacturers had come down to brass tacks and were showing the public what the public had come to see.

No Longer a Marvel

They had come to see television receivers as well as wireless sets. There wasn't much doubt about that. And my impression, from what I saw and heard here and there, was that the period of mere marvelling at television was over: the enquirers were fully alive to the entertainment value of television, and most of them were seriously considering the installation of receivers in their homes, if they hadn't already made up their minds to do so.

The Services' stands were of considerable interest, though the organisers of each were naturally much handicapped by not being able to display devices that would indeed have produced thrills! But what they gave

us was enough to show that they aren't exactly behind the times. Something more than a word of thanks is due to the able and most willing demonstrators on all these stands.

There are, those, and I am one of them, who lament that the fun-fair side of the Exhibition was so strongly stressed in the advertisements of Radiolympia. These urged you to come and be televised, to visit Miss Radiolympia's boudoir, to see the stars in the theatre; they also mentioned that there were wireless sets and television receivers on view. It was the worst of bad luck that the Exhibition should coincide with the crisis. But for that, I feel that it could well have stood on its own feet as a radio show, without the help of the boudoir or the great bowl theatre. The purely technical "sideshows" always seemed to be well patronised, and it was noticeable that many of the visitors were professional wireless people.

HENRY FARRAD'S SOLUTION

(See page 230)

IF the instruction book is correctly quoted by the correspondent, it is not a very good one. Stations should be tuned in first with the *greatest* selectivity, and the response then broadened out if conditions

permit. If a station is tuned with least selectivity, it is difficult or even impossible to do so accurately. Especially is this so if the variable selectivity is not much more perfect than is often the case. A common fault is that the response curves at the extremes of the selectivity control are something like those shown here. When tuned at the least selective setting it is natural to bring the wanted station, W, in line with the peak. If the frequency separation of an unwanted station is represented by that between W and U, it is likely that some interference from U will be heard. If the selectivity is increased to get rid of U, it can be seen that W will be cut out and U remain almost unaffected.

Although this asymmetrical broad response curve is not ideal, the system could at least be made to serve its purpose by tuning with maximum selectivity. W would then come where U is shown, and U would be excluded. Conditions permitting, the best would also be obtained from the wide response adjustment.

Theory and Design of Valve Oscillators, by H. A. Thomas, D.Sc., M.I.E.E. Pp. 270+xvi. Published by Chapman and Hall, Ltd., 11, Henrietta Street, London, W.C.2. Price 18s.

THIS book is Volume VII of a series of monographs on electrical engineering and deals very thoroughly with the problems associated with valve oscillators. Fundamental principles are treated in the first chapter and types of oscillators and the conditions for oscillation in the second. Here the close relationship which exists between many apparently dissimilar circuits is well brought out by their derivation from a single prototype. The dynatron and multi-vibrator are not omitted, and in Chapter III the efficiency of oscillators is dealt with in some detail.

This occupies 76 of the 270 pages, and apart from the bibliography and index the rest of the book is devoted to the problems of frequency stability in one form or another. There are chapters on frequency drift due to the valve, to the effect of temperature on the coils, the effect of temperature on condensers, as well as the stabilisation of the maintaining system, the inductance, and the capacity. The book concludes with a chapter on methods of obtaining automatic frequency stabilisation.

Crystal-controlled oscillators are not treated, the discussion being confined to uncontrolled oscillators. Among the methods of stabilising the valve circuit, it is shown that much can be done by the choice of suitable circuit values. The author gives a list of seven principles, which are not mutually exclusive, by the observance of which a considerable improvement can be obtained. Special circuits, such as the Franklin oscillator, the phase-compensated oscillator, the line-stabilised oscillator, the Kolster high-Q circuit, and the Dow circuit, are dealt with.

It is often believed that frequency variations are due chiefly to the valve and the voltage supplies. The author shows that while they undoubtedly affect the frequency appreciably, the effect of temperature on the coils and condensers is often much greater. The chapters dealing with the stabilising of inductance and capacity are thus especially important.

The book is admirable for its lucidity and accuracy. The treatment is often mathematical, but it is rarely necessary to follow the equations in order to obtain a qualitative understanding of the subject. The book is consequently of considerable value to the non-mathematical, and can confidently be recommended to all interested in this important subject. W. T. C.

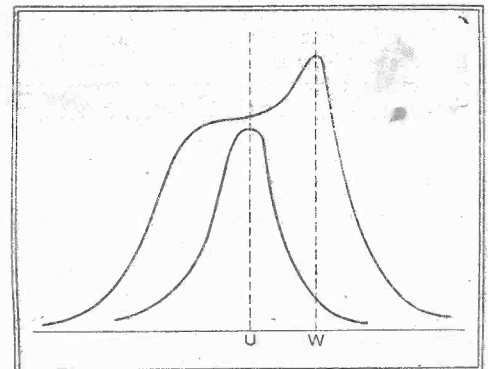

Typical resonance curves for alternative settings of a selectivity control.

Cathode-ray Photography

MAKING PERMANENT RECORDS FROM OSCILLOSCOPES AND TELEVISION SCREENS

By JOHN H. JUPE

This article gives information on the choice of films and plates for use in photographing cathode-ray tube screens of various types. It also deals with such questions as exposure, aperture and reduction of image; formulæ for developers are also given.

WITH the ever-increasing use of cathode-ray tubes the recording of the images by photographic means is likewise increasing, and although in some respects the methods follow those of normal photography, there is at the same time much difference.

Television is in the "normal" class, whilst oscillograph traces are more allied to the older scheme of recording with a moving spot of light. For television photography the problem is simply to record a projected picture, and it can be dealt with in much the same way, with regards to apparatus, materials, exposure and development, as a normal scene.



Any ordinary camera is suitable, providing it is fitted with a fast lens, $f4.5$ or faster, and a focusing device, reflex or otherwise. To increase the size of the image on the negative, a portrait attachment or other "close up" lens is desirable, but most important of all is that suitable negative material should be used. This applies to every class of cathode-ray photography, and to assist in classifying materials the fluorescent screens can

be considered under the following headings.

(1) Screens with green images. (2) Screens with blue-green images. (3) Screens with blue images. (4) Screens with red images. (5) Screens with black-white or sepia images.

In most cases the groups 4 and 5 require the same materials, but as group 5 is used almost exclusively for television it is quoted separately.

Almost any good make of plate or film may be used, but to give examples of suitable types, tables of various kinds made by two manufacturers have been prepared. Obviously other equivalent makes could be substituted in any group, and the materials in each section are arranged in order of sensitivity.

Exposure for Television

Exposures in cathode-ray photography are determined by a number of factors, though in television scenes the matter can be simplified owing to the limits set by the brightness of the screen and the number of frames per second. Only experiment can show what is most suitable, but $1/25$ th second is the fastest exposure suitable for present-day television, and this exposure at $f4.5$ and a fast panchromatic film should provide a basis upon which to operate. Normal developers are most

suitable for this work, and "soft" or "contrasty" ones should be avoided.

In the case of other cathode-ray

An example of an untouched photograph of a television picture produced on a 9 in. tube. The photo was taken with an exposure of $1/14$ th second and an $f4.5$ lens.

photographic work further matters must be considered, and the problem must be solved by a compromise between the following:

(1) Brightness of the screen. (2) Writing speed of the tube. (3) Aperture of the taking lens. (4) Spectral radiation from the screen. (5) Spectral response of the photographic emulsion. (6) Magnification at which the photograph is made. (7) Developing conditions.

The brightness of the screen can often be improved by designing the electrical circuits so that the control grid voltage is reduced during the time a transient

occurs. Of course, the screen would necessarily be damaged by such high intensities of radiation as it would then be

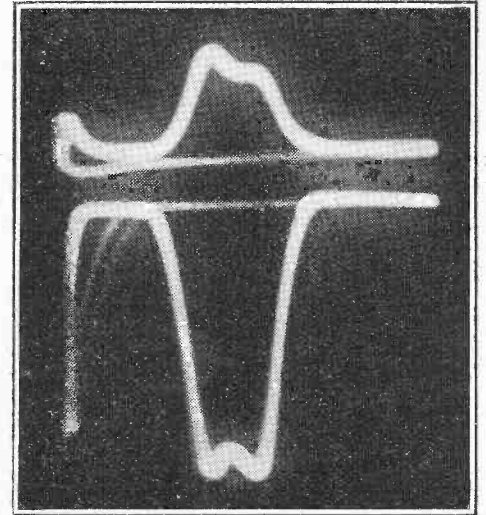

Photograph of a simultaneous oscillogram of resonance curves taken across primary and secondary of an IF transformer.

subjected to, but as the damage is a function of the screen input power per unit area, per unit time, the momentary increase has practically no effect on the life of the tube. This method usually gives greater photographic speed than the use of larger aperture lenses. It is useful to know, too, that the intensity of the screen image is roughly proportional to:

(1) the square of the control grid voltage.

(2) The second anode voltage, all other voltages being kept constant. Consequently, if exposures are known for one set of voltages, others can readily be calculated.

An alternative method for the photography of non-repeating transients is to use a tube with a red screen which usually has a very long afterglow. In this case panchromatic materials are the only ones possible.

Lens Aperture

Taking the other points in the list of variables, aperture of lens is fixed by the equipment available, whilst spectral conditions of screens and emulsions are covered to a great extent by Tables 1 and 2 (overleaf). Apart from developing conditions, which will be dealt with later, there is the tremendously important question of the writing speed of the tube. This is linked with the magnification at which the record is made, and the optical

Cathode-ray Photography—

side of this matter can be expressed by the formula

$$\frac{I_2}{I_1} = \frac{1}{16N^2 \left(1 + \frac{1}{M}\right)^2}$$

where

I_2 is the light intensity of the image
 I_1 is the light intensity of the object
 M is the linear ratio of object size to image size.

N is the aperture of the lens, from which it can be seen that a large geometrical reduction is advantageous. Practical considerations generally limit this to about 3:1, and in any case, a further reduction only improves the writing speed slightly. The actual speeds obtainable with photographic recording vary with the films used, and may possibly be below the maximum writing speeds of the tubes. For instance, variations between 37 and 125 metres per second are quite possible, merely by using another kind of film, the tube, of course, remaining the same.

Choice of Developer

For the development of negatives used in cathode-ray photography regular methods may be followed in general. The quality of the image is very important, and good contrast is desirable, but where the "spot" travels at rapidly varying speeds an attempt to obtain maximum contrast will often result in parts of the record being obliterated.

Broadly speaking, it is best to develop for contrast any records which do not show great variations of "spot" speed, and to use a normal developer where rapid movements occur irregularly. High degrees of enlargement from small negatives may force the use of fine grain developers, but their use is not recommended for oscillograph photography.

The following list gives developers, etc., suitable for cathode-ray recording,

TABLE 2.
FILMS AND PLATES SUITABLE FOR CATHODE RAY PHOTOGRAPHY MADE BY KODAK, LTD.
ITEMS IN EACH GROUP ARE GIVEN IN DECREASING ORDER OF SENSITIVITY.

Films or Plates	COLOUR OF FLUORESCENT SCREEN.				
	Green	Blue-Green	Blue	Red	Black-White
Roll Films (in standard sizes).	Verichrome. Super XX. S.S. Pan. Panatomic X. Panatomic.	Verichrome. Regular N.C. S.S. Pan. Panatomic X. Panatomic.	Verichrome. Regular N.C. S.S. Pan. Panatomic X. Panatomic.	Super XX. S.S. Pan. Panatomic X. Panatomic.	Super XX. S.S. Pan. Panatomic X. Panatomic.
Film Packs.	Verichrome. Super XX. S.S. Pan. Panatomic X. Panatomic.	Verichrome. Regular N.C. Panatomic X. Panatomic.	Verichrome. Regular N.C. Panatomic X. Panatomic.	Super XX. S.S. Pan. Panatomic X. Panatomic.	Super XX. S.S. Pan. Panatomic X. Panatomic.
35 mm. Roll Film.	Super XX. Super X. Plus X. S.S. Pan. Panatomic X. Panatomic.	Super XX. Super X. Plus X. S.S. Pan. Panatomic X. Panatomic.	Super XX. Super X. Plus X. S.S. Pan. Panatomic X. Panatomic.	Super XX. Plus X. S.S. Pan. Panatomic X. Panatomic.	Super XX. Super X. Plus X. S.S. Pan. Panatomic X. Panatomic.
Plates.	0.800 P.1200 P.800 0.500	0.800 0.500 P.1200 P.800	0.800 0.500 P.1200 P.800	P.1200 P.800 P.500	P.1200 P.800 P.500

and, like the film and plate tables, is only intended to be representative.

Kodak Special Developer (D.163)

Stock Solution Avoirdupois
 Elon .. 80 grains
 Sodium Sulphite, cryst. .. 12 ozs.
 Hydroquinone .. 1 oz. 160 grains
 Sodium Carbonate, cryst. .. 14 ozs.
 Potassium Bromide .. 100 grains
 Water, up to .. 80 ozs.
 Dissolve in the order given.

For use, dilute 1 part of stock solution with 3 parts of water. For tank use develop for 6-10 minutes at 18°C. For dish use develop for 5-8 minutes.

Kodak High Contrast Developer (D.19)

Stock Solution Avoirdupois
 Water (warm) .. 32 ozs.
 Elon .. 64 grains
 Sodium Sulphite, cryst. .. 12 ozs. 360 grains
 Hydroquinone .. 256 grains
 Sodium Carbonate, cryst. .. 8 ozs. 234 grains
 Potassium Bromide .. 150 grains
 Water (cold) up to .. 64 ozs.
 Use at full strength.

Development time, 8 minutes at 18°C.

TABLE 1.

FILMS AND PLATES SUITABLE FOR CATHODE RAY PHOTOGRAPHY MADE BY ILFORD, LTD.
ITEMS IN EACH GROUP ARE GIVEN IN DECREASING ORDER OF SENSITIVITY.

Films or Plates	COLOUR OF FLUORESCENT SCREEN.				
	Green	Blue-Green	Blue	Red	Black-White
Roll Films (in standard sizes).	Selochrome. H.P.2. Selo F.P.	Selochrome. Selo. Selo F.P.	Selochrome. Selo. Selo F.P.	H.P.2. Selo F.P.	H.P.2. Selo F.P.
Films in widths and lengths to order.	Oscillograph Film, Type M.	Oscillograph Film, Type M. Oscillograph Film, Type F.	Oscillograph Film, Type M. Oscillograph Film, Type F.		
Film Packs.	Selochrome. H.P.2.	Selochrome. H.P.2.	Selochrome. H.P.2.	H.P.2.	H.P.2.
35 mm. Roll Films.	Selochrome F.G. H.P.2. F.G. Pan.	Selochrome F.G. H.P.2. F.G. Pan. Oscillograph Film, Type F. Selo Sound Recording Film.	Selochrome F.G. H.P.2. F.G. Pan. Oscillograph Film, Type F. Selo Sound Recording Film.	H.P.2. F.G. Pan.	H.P.2. F.G. Pan.
Plates.	Double X-Press Selochrome. H.S. Pan.	Double X-Press Selochrome. H.S. Pan.	Double X-Press Selochrome. H.S. Pan.	H.P.2. H.S. Pan. Soft Gradation Pan.	H.P.2. H.S. Pan. Soft Gradation Pan.

Ilford M.Q. Developer (ID-2)

Stock Solution Avoirdupois
 Metol .. 20 grains
 Sodium Sulphite, cryst. .. 3 ozs.
 Hydroquinone .. 80 grains
 Sodium Carbonate, cryst. .. 2 ozs.
 Potassium Bromide .. 20 grains
 Water, up to .. 20 ozs.
 For dish use, dilute 1 part with 2 parts of water. For tank use, dilute 1 part with 5 parts of water. For dish use, develop for 3½-5 minutes at 18°C. For tank use develop for 7-10 minutes at 18°C.

Ilford Pyro-Metol Developer (ID-4)

Solution A Avoirdupois
 Metol .. 35 grains
 Potassium Metabisulphite .. 100 grains
 Pyrogallol Acid .. 100 grains
 Water, up to .. 20 ozs.
 Solution B
 Sodium Carbonate, cryst. .. 4 ozs.
 Water, up to .. 20 ozs.
 For use mix equal parts of A and B.

Ilford Oscillograph Developer (ID-33)

Avoirdupois
 Metol .. 100 grains
 Sodium Sulphite, cryst. .. 4 ozs.
 Hydroquinone .. 160 grains
 Sodium Carbonate, cryst. .. 4 ozs.
 Potassium Bromide .. 100 grains
 Water, up to .. 40 ozs.
 Use at full strength.
 Development time, 5-10 minutes at 18°C.

Acid Fixing Bath for Plates and Films

Avoirdupois
 Sodium Hyposulphite .. 16 ozs.
 Potassium Metabisulphite .. 1 oz.
 Water .. 40 ozs.

Combined Fixing and Hardening Bath

Avoirdupois
 Sodium Hyposulphite .. 12 ozs.
 Potassium Metabisulphite .. 1 oz.
 Chrome Alum .. ½ oz.
 Water .. 40 ozs.

The hypo and the metabisulphite are dissolved in 20 ozs. of hot water and allowed to cool. The chrome alum is then dissolved in 10 ozs. of warm water and added to the remainder of the bath when cool. Finally, the amount of solution is made up to 40 ozs. with cold water.

The information given here is sufficient to cover most cathode-ray photography in ordinary engineering research, but for special purposes contact should be made with the makers of films and plates. The writer's thanks are due to Kodak, Ltd., A. C. Cossor, Ltd., Ilford, Ltd., and the Eastman Kodak Company of America for their help in supplying him with data.

The Mechanics of Receiver Design

TEMPERATURE — HUMIDITY — VIBRATION

It is not always sufficiently well realised that wireless apparatus has its mechanical side as well as its electrical. Considerable attention is paid to the electrical design, but sometimes the mechanical is slipshod. This is especially so in the case of home-made apparatus and is due partly to an incorrect choice of components and partly to poor workmanship on the part of the constructor himself. The former is due chiefly to a desire to save money, for the best components are rarely cheap, and the latter to an excess of enthusiasm which leads him to rush the construction in order to get the apparatus working.

In the electrical design certain definite values of resistances, capacities, inductances, and valves are called for, as well as certain degrees of screening and insulation. These values are optimum ones and are rarely precisely realised in practice. It is, for instance, very unlikely that if one buys a 10,000-ohm resistance its value will be precisely 10,000 ohms—it may be anything between 9,500 ohms and 10,500 ohms. Moreover, its value will vary somewhat with temperature.

All components and valves are subject to similar variations in different degrees, and as far as possible the designer has to see that the performance of the apparatus is not greatly affected by these probable departures from the optimum values. In very many cases quite large alterations in component values have only a moderate influence on performance. The majority of the resistances and fixed condensers in a receiver, for instance, are by no means critical and normal tolerances on their values are ± 10 per cent. or even ± 15 per cent.

Components associated with the tuning arrangements, however, are very critical and it is usually unsatisfactory to specify fixed values. Coils and variable condensers may be specified with tolerances of ± 1 per cent. or ± 0.5 per cent., but adjustable capacities are always provided so that the precise values needed can be obtained by adjusting them while the receiver is in operation.

Temperature

All this is well known and is allowed for by the designer. What is not always remembered is that the value of a component may not be constant but may change with time, temperature, humidity, and vibration. If the changes are moderate and slow and they occur in non-critical parts of the set, they may not be of much importance. Thus a resistance in an AF amplifier might conceivably change from 10,000 ohms to 11,000 ohms over a period of an hour or so. While readily measurable, the result might well be inaudible.

THE mechanical side of a receiver is often given much less attention than the electrical; in fact, it is only comparatively recently that its importance has become realised to any great extent. The effect of temperature upon the performance is another point which deserves the serious consideration of the designer. These matters are discussed in some detail in this article and the effects of poor design are described.

On the other hand, much smaller rapid and erratic variations are likely to cause rustling noises and are consequently very definitely undesirable.

Troubles of this nature arise less in components themselves than in badly made connections to them. A dirty or badly soldered joint has an erratically variable resistance and is a common cause of noise.

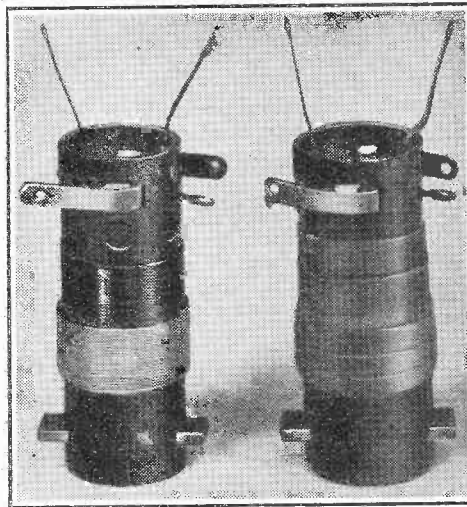

This photograph shows two similar coils, one unfinished and the other dipped in wax.

It is only natural to find that variations in components affect the performance most when those components are in the more critical circuits. Condensers and coils can be badly affected by temperature, humidity, and vibration and so the tuning of the various circuits is affected, leading to reduced sensitivity and selectivity.

Temperature changes may be cyclic. This means that if we take a condenser of known capacity and change its temperature there will be a certain change in capacity; if we bring it back to its original temperature, however, it will also go back to its original capacity. With a non-cyclic change, however, the capacity would not come back to its original value, but would take up a new value between the two. In addition to short-term variations which follow the temperature changes, there is a

long-term alteration in capacity which is more or less permanent.

Most people have noticed that the tuning of a receiver drifts during the first ten minutes or so after switching on. This drift is caused by changes in coils, condensers, and valves while they are warming up, and it does not cease until they have acquired their final temperature. This is the short-term variation; the long-term changes are much less noticeable, partly because they are slower and partly because they are of less magnitude. They affect the performance in the same way, however, and at length make it necessary to re-gang the receiver.

The complete avoidance of these effects is probably impossible, but they can be very greatly reduced by good design. One method is to associate components having positive and negative temperature coefficients. A coil with a positive temperature coefficient, for instance, may be tuned by a condenser having a negative coefficient, so that the product of inductance and capacity, and hence the resonance frequency, is a constant and independent of temperature.

Apart from these expedients, however, it often happens that much of the drift experienced is due to mechanical defects in the apparatus rather than to normal temperature variations. Let us, therefore, consider the important components in turn.

Electrically, the average IF transformer is quite a good component, but mechanically it is not always up to the same standard. If a transformer is set up, adjusted, and its resonance curve is measured, and is then subjected to vibration and temperature and humidity changes such as are normally encountered in practice, it will be found that the resonance curve has altered. Sometimes the changes are of a minor character, sometimes they are large.

Usually, the peak of the resonance curve is displaced somewhat, and its height is reduced. In extreme cases, a single-peaked curve may become double-humped and displaced by as much as 5 kc/s from the true intermediate frequency. Sometimes, too, there is a big drop in efficiency.

Normally, the trimmers are responsible for the major changes. Many, but by no means all, trimming condensers of the mica-dielectric compression type are badly affected by vibration and temperature. It

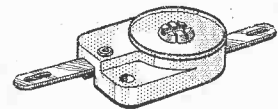

A temperature compensated condenser.

is changes in the trimmers which cause a large part of the shift in position of the resonance curve, and which in bad cases

The Mechanics of Receiver Design—

cause the appearance of a double-humped curve. Humidity affects the losses in the trimmer, but usually not to a very serious degree with the changes normally experienced in this country.

The temperature effect on the coils is chiefly to expand or contract the copper and the coil former. It is likely to be more nearly cyclic than in the case of trimming condensers. The effects of humidity on the coils may be very serious if the coils and their formers are not impregnated. An increase in humidity will then seriously lower the efficiency.

If the coils are home-made they are often left unimpregnated. Although the initial efficiency may then be higher it is unlikely to be retained unless the coils are kept in a dry atmosphere, which is not always possible. It is, therefore, advisable to impregnate them and paraffin wax is quite good for this. Unless the former is of ebonite or similar fairly hard material it is likely to shrink during the process of impregnation and so lead to trouble.

With wooden or card formers the best course is to prepare the former, dry it well in a hot oven, and then dip it in molten paraffin wax. After shaking off the surplus wax, it should be left to dry. After winding, the coil (and former, of course) should be dried in the oven and then dipped in wax, again shaking off the surplus. Such a coil, although it loses a little in Q , will remain very largely unaffected even by extremes in humidity. If desired shellac can be used instead of wax, and is sometimes more convenient.

Vibration has little effect on the coils provided that they are rigidly mounted. This is important, for in some forms of construction very small relative movements of the coils have a big effect on the coupling between them, and hence on the selectivity and efficiency. Movement of the coils in relation to the screening can, wiring and trimmers also affects the tuning of the circuits in some degree.

Trimmers

The trimmers are most important and their importance increases rapidly with the selectivity. If compression-type trimmers *must* be used on account of their small size and cost it is a good plan to use only very low capacity trimmers and to obtain the bulk of the capacity in fixed ceramic-type condensers. Air-dielectric trimmers are best if they are soundly made with good bearings. Good air trimmers are substantially free from vibration troubles, are capable of more accurate initial adjustment, are less affected by humidity, and are more cyclic in their temperature variations than compression types. Some of the latest patterns of the latter, however, are very good and are greatly superior to older ones.

In order to avoid the condenser troubles permeability trimming has been evolved. Here a fixed ceramic-type condenser is used, because of its stability and low losses, and the coil is provided with a

movable powdered iron core. This scheme is perfectly satisfactory if properly carried out and is then as good as an air trimming condenser. If it is badly done, however, it is as bad as a poor compression trimmer. Everything depends on the mechanical design of the movable core system. The core must fit the coil former without side play, and once its longitudinal position has been determined it must stay there unaffected by vibration.

This is easier said than done, but it can be done, and the result is that permeability trimming is becoming more common. It

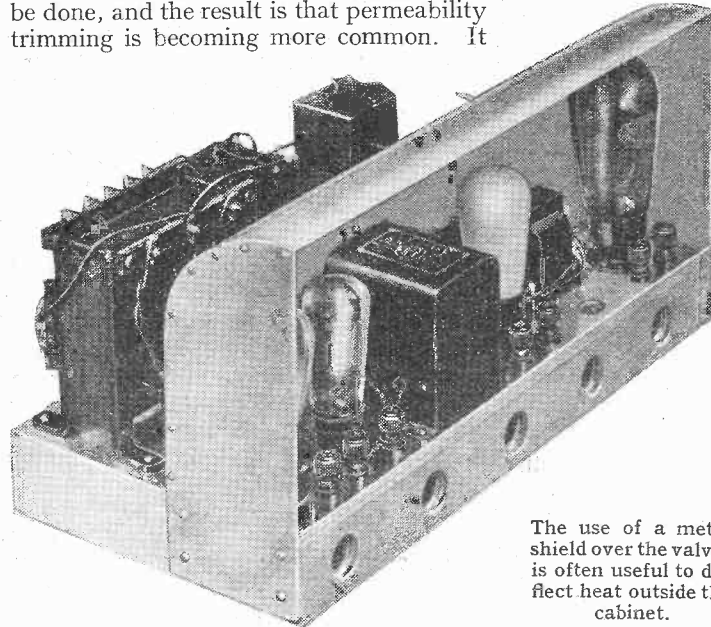

The use of a metal shield over the valves is often useful to deflect heat outside the cabinet.

is probably no better than an air-dielectric trimming condenser, but can be as good if properly made and is cheaper and more compact.

Very similar considerations apply in the case of the signal-frequency tuned circuits, but to a lesser extent owing to their lower selectivity. The use of capacity trimmers is usually essential, because it is necessary to equalise the stray capacities of the various circuits in order to maintain accurate ganging. For reasons of cost mica-type compression trimmers are nearly always used; it is, therefore, important to choose good ones. If they can be afforded, there is no doubt that air trimmers are better, but they take up more room.

The most important circuit of all is the oscillator. This is because it has the whole selectivity of the IF amplifier behind it, and a given change in capacity or inductance has more effect on the performance here than anywhere else. Although the other circuits can be quite important, the cause of the major part of the drift commonly encountered lies in the oscillator. The troubles here, however, are not only of a mechanical nature but also of an electrical.

Among the electrical troubles, drift is caused by supply voltage variations. This can be reduced in some degree by special circuits and substantially eliminated by the use of voltage stabilisers. The application of AVC voltage to the mixer is also liable to cause trouble. Changing the bias of the mixer is liable to react on the oscillator and alter its frequency. In the reception of a fading signal, therefore, the continual changes of bias make the oscillator

frequency vary, and the net result may be worse than if there were no AVC. This effect has been greatly reduced in modern frequency-changer valves, and can in any case be avoided by omitting to control this stage for AVC purposes.

On the mechanical side the troubles differ only in degree from those encountered in the IF amplifier and the remedies are consequently the same. It may be remarked, however, that even when all precautions have been taken to use only mechanically sound components, temperature variations are inevitable and have a very appreciable effect on the oscillator frequency.

The variations are of two kinds—those due to the weather and those due to the set itself. Under average domestic conditions the room temperature keeps within the limits of 40-80 deg. F.; in the extremes of winter and summer the variations may occasionally be greater. In summer the variations within 24

hours are not likely normally to exceed 60 deg. at night to 80 deg. during the day. In winter the change may be from 40 deg. at night to 70 deg. during the day when the room heating is in operation. Under average conditions the maximum change of room temperature during 24 hours is not likely to exceed 30 deg. F. or some 17 deg. C. During a listening period the change is likely to be much less. In winter one may come into a cold room and switch on set and heating together and so obtain a change of room temperature of 20 deg. F. or so within an hour or two's listening period. More often, however, the room temperature is fairly even during the listening period and only varies a few degrees.

The changes in room temperature tend to be slow and of moderate order during a considerable period. They consequently cause little noticeable tuning drift. They may just noticeably affect dial settings between winter and summer.

Internal Heat Generation

The self-generated heat of the receiver is another matter, however. Quite a large amount of heat is produced in the receiver. If we take an average case of a receiver with its mains equipment and loud speaker all in one cabinet, then the whole of the power input to the set from the mains, plus the RF power input and less the acoustic power output is dissipated as heat within the cabinet.

The input RF power is negligibly small and the acoustic power radiated as sound by the speaker is also small. It rarely

The Mechanics of Receiver Design—

amounts to more than 10 per cent. of the power output of the output stage. Even this is only developed on peaks of music, and the result is that the average acoustic power is very small indeed compared with the power input from the mains. We shall not be far wrong in saying that the whole of the mains power input is dissipated as heat in the cabinet; this is with a Class A output stage, and is strictly true during intervals in the programme.

The power consumed by an average set varies from about 60 watts for the smaller types to 120 watts for the larger. This produces quite a large amount of heat and in the confined space of the cabinet results in an appreciable temperature rise.

When the set is switched on it is at room temperature. Afterwards its temperature rises until the loss of heat by conduction, radiation and convection is exactly equal to that supplied to it internally. The final temperature and the time taken to reach it depend on many factors, among which the most important are the amount of heat generated and the ventilation of the set. Conduction and radiation convey little heat from the set, since the cabinet is usually of wood or some other poor conductor of heat, and is usually polished so that it is a poor radiator. The heat loss is mostly by convection.

Ventilation

If the final temperature is to be kept at a minimum, it is essential that the air be allowed to circulate freely round all parts of the set. The most important factors in obtaining this are the provision of adequate outlets and inlets for air at the top and bottom of the set respectively. The common pierced back to the cabinet, while better than nothing, is by no means ideal.

The best arrangement is probably to have a series of large holes spread over the base of the cabinet, which is provided with small feet to allow the free passage of air to these holes. Similar holes in the top of the cabinet are

Good ventilation can often be secured by making the outlet holes a part of the cabinet decoration.

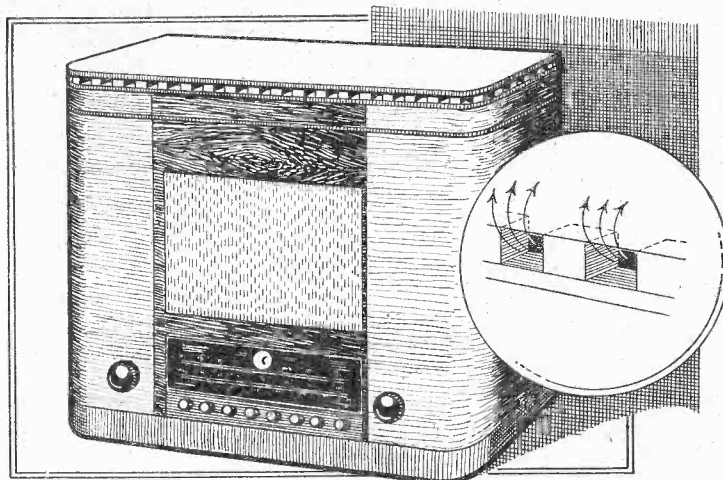

needed to allow of the emergence of the heated air. If the chassis fills the cabinet, as it usually does, then it must be pierced with an adequate number of air holes, or the ventilating scheme will be largely nullified.

All this is easy except for the top holes, which are likely to spoil the appearance of the cabinet. With careful design, however, the holes can be disguised. For instance, the method shown in the above

sketch can be adopted. Alternatively, metal deflecting cowls can be provided above the set to carry the air to the upper half of the back and prevent its being trapped in the top of the cabinet. This course is probably the most convenient in the case of a radio-gramophone. To prevent the entry of dust the holes can be covered with fine gauze, but they should then be somewhat larger.

Layout of Components

In spite of good ventilation, all parts of the receiver will not reach the same temperature. Consequently, it is important in design to keep those parts which should operate at a constant temperature away from the hot spots. The output valves and rectifier are generally at the highest temperature and should be kept well away from all tuning circuits, especially the oscillator. The mains transformer, too, may get quite warm if it is not very efficient, and there are nearly always several hot resistances. The speaker field should not be overlooked, since 6-12 watts are commonly dissipated within it. Economy in total power consumption is important in that it minimises the total heat produced in the set.

By careful attention to detail in design frequency drift can be reduced well below the figures often obtained. The important factors are the avoidance of an unnecessarily large production of heat in the receiver cabinet (instead of having everything in one cabinet, place speaker, amplifier and mains equipment in one, and the tuner in another), the use of a cabinet of adequate size and with properly arranged ventilating holes, the layout of the components so that the important parts are well spaced from hot components, the proper choice of condensers and coils for

good mechanical and thermal properties as well as electrical, the stabilisation of oscillator voltages, and the balancing of components with positive and negative temperature coefficients. This last is difficult for the amateur, but all the others are well within his scope. They lead to an increase in size and cost of apparatus, unfortunately, but this is repaid by the improved stability and reliability of the performance.

Five-metre DX

August a Quiet Month

THERE is an interesting paper in the proceedings of the I.R.E. for August, 1939, dealing with observations made on ultra-short waves over distances within and beyond optical range. Three receiving sites, all located in a direct line, were chosen, one at 32 miles just within the optical range, another at 72 miles, which was just beyond, and the third at 172 miles. Simultaneous recordings of signal strength were made at each station, the observations extending over a considerable period.

Though most of the facts revealed in the analysis of the charts are already known, or at least a shrewd idea of their nature has already been formed by many workers in this country, it is very satisfying to obtain authentic confirmation of one's own findings.

For example, it is revealed that signal strength fluctuations at station B (72 miles) rarely coincide with those at C (172 miles). Anyone who listens consistently on five metres will doubtless have reached the same conclusions, as one often hears a station not 10 miles away reporting bad fading of signals that, according to one's own observations, are comparatively steady.

Another interesting fact revealed is that the average signal strength increased after dark at all stations. Within the optical range, the increase was 1.5 to 7 decibels, though fading did not necessarily become worse after dark. Day-to-day variations in average field strengths were observed.

Beyond the optical range a noticeable increase was observed after dark, but as fading is far more prevalent the average increase is less easily determined.

Within and just beyond the optical range, it is quite possible for signals to show an increase in strength at night equivalent to doubling the power at the transmitting end. Observations were made on two frequencies: 49.5 Mc/s and 52.75 Mc/s.

Turning to conditions at home, only occasional has listening been possible on five metres for the last two weeks in August, and in consequence the writer's own observations contain very little of interest. G8KD in Sheffield (130 miles) was received at good strength when using telephony, but a contact could not be effected; this was a pity, as conditions appeared to be quite good.

G2OD now has his Yargi array in operation, and general improvements made to the transmitter have led to about 30 watts of RF being fed to the aerial. This accounts for the very good and consistent signal that is received in N.W. London at 55 miles, and also much farther afield on most occasions.

In a report covering the period, July 26th to August 26th, G6DH notes a marked falling off in 56-Mc/s activity at the end of July, and while several days in August were particularly good for long-distance "extended ground wave" transmission, only a few amateurs' stations were audible.

July 29th was a good night; G6DH effected his longest G contact, this being with G8JVP at 170 miles. As previously reported, this station occupied a very good position on this occasion.

"August 15th, 17th and 21st were all good days for short skip," says G6DH, and on the 16th and 17th G8KD in Sheffield was heard on 'phone at R6 with some fading. The distance would be 160 miles. In all, some 15 stations, all over 50 miles were heard, and signals exchanged with most of them.

G2MC.

American Progress—and Ours

WHERE BRITAIN LEADS IN WIRELESS TECHNIQUE

FOR a good many years it has been possible to parody a well-known claim of a certain moist city in the North (which shall be nameless) by saying that what America does in radio now we shall be doing next year or the year after. Personally, I have found this extremely satisfactory, because for the price of subscriptions to the leading American technical journals I could put myself in an impregnable position in relation to those people—you know the sort!—who are always asking, "Well, what's the next thing going to be in wireless?" For example, about a year and a half ago, when push-button receivers were prac-

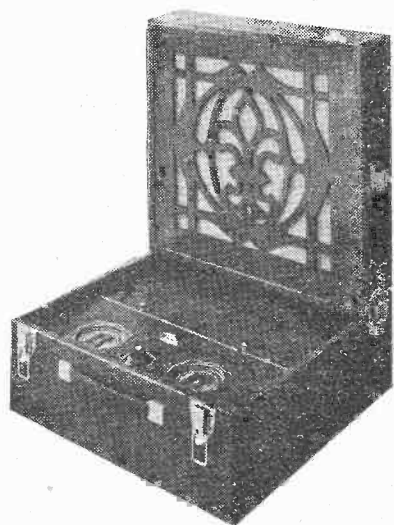

Ten years ago the typical portable weighed 30 lb.—and cost the same number of pounds sterling.

tically unknown here, I had no hesitation in predicting that they would sweep the board at Radiolympia. They did. Incidentally, we seem now to have gone in for them even more wholeheartedly than the Americans, and our designs are no less advanced than theirs. A year or two earlier it was possible to prophesy the addition of the short-wave band. And so on.

But now my reputation is about to totter, for its foundations have shifted. The horse's mouth is running dry. Last year it spoke with an uncertain sound, and this year the horrid suspicion is confirmed. I turn to a review of progress published in a recent issue of one of my most reliable sources of advance information from across the Atlantic, and what do I find? Under the title "The Art Advances," one of the first things that hits the eye is this: "The outstanding contribution in radio sets within recent months is the battery-operated portable receiver." I wonder how many people here can cast their minds back ten years and remember what they saw around them in this exhibition. There may have been other types of model

THIS article is based on a lecture given by Mr. M. G. Scroggie at the opening meeting of the Technical Convention at the National Radio Exhibition on August 27th. Remarks of subsequent speakers are reported elsewhere in this issue.

exhibited, but so far as real sales were concerned the only type that really mattered was the battery-operated portable receiver. The firm I was with then was working day and night turning them out by the thousand. But when I took one over to the U.S.A. it was a complete novelty, even among the technicians.

Portables are still popular. You will find them on many of the stands outside; perhaps I would be correct in saying *most* of the set makers' stands. Ten years ago portables weighed about 30lb. and cost about the same figure. Now, a typical price is in the region of £6 and weight 12lb. There are, of course, others even cheaper and lighter. The modern portable is devoid of any wet battery with its acid that always seems to find its way out, causing many of the faults to which the old portables were prone.

This may be one reason for the belated appearance of the portable in America. They may have been waiting till it could be worked without an accumulator. The reason actually given in the journal I have been quoting is a curious one. Designers have been finding that frame aerials, properly screened, are helpful against types

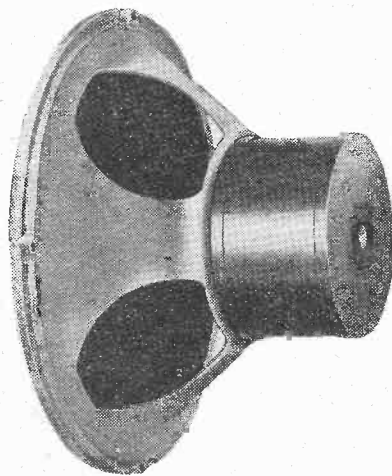

British high-efficiency PM speaker with a magnet giving a flux density of 13,000 lines per sq. cm. ($1\frac{1}{2}$ in. pole).

of interference in which the electrostatic field predominates. Then they were surprised to find how many stations could be

picked up on them. The model I took over ten years ago could receive about two-thirds of the stations then working in Europe—but not when it was in America, of course—even with the valves available at the time; but then our publicity is so bad!

Another contributory feature is the high-efficiency permanent-magnet loud speaker, which is still quite new in America, though well established here, thanks to the efforts of the Sheffield metallurgists, who put us in the lead in this department with a succession of magnetic alloys. It is common in this country to find PM speakers giving a higher efficiency than the corresponding energised types and being employed where energised types would be technically feasible.

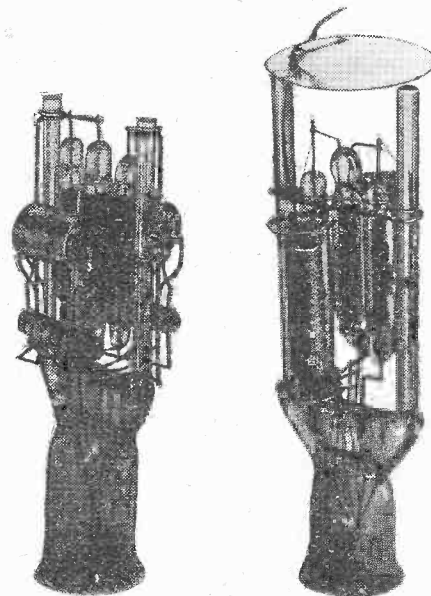

Multiple valves in Europe date back to 1926, when they included not only several electrode systems but the inter-stage couplings as well.

Turning again to "The Art Advances," we find among the new "tubes" one that readers are expected to find almost incredible. It is described as "a pentode, a triode and a diode all bound in one envelope." This is no more sensational than the old Loewe valve which contained not only three valves in one "bottle," but also all the couplings, etc., for a complete receiver! It scored a big commercial success as long ago as 1926; so much so that the Loewe Company suspended the manufacture of single types. More recently, too, we had a burst of enthusiasm on the part of the valve makers for multiple valves; but when it was seen that the permutations and combinations of existing types would swell the already excessively bulky valve lists out of all reason, and that many of the combined types offered no technical advantage—in

American Progress—and Ours —

fact, quite the contrary—there is now a disposition to combine valves only when there is some solid justification for it.

Secondary Emission Valves

Talking about valves; one of the most significant recent developments has been the use of secondary emission. For some time we have had several types on the market, giving phenomenally high mutual conductance; and in this exhibition are to be seen secondary emission valves with a conductance of nearly 40 mA/V. Another valuable advance is the abolition of the top cap connection. I hope I will be justified in predicting that before many more Radiolympias have gone by the component makers will have been able to scrap their tools for the variously shaped hats that so many of our valves still wear. There are signs that the time-honoured pinch form of construction has at last been recognised to have outlived its usefulness so far as valves are concerned; and by its abolition valves will gain in stability and freedom from loss. Progress in these directions has been going ahead on both sides of the Pond, but I think it is safe to say that at the moment Europe leads on points.

Quoting once more from the description of the new American valves: "The heater voltage of these combination tubes runs as high as 70 volts, to avoid the necessity of dropping the line voltage within a resistor, ballast tube or line cord." In 1933 *The Wireless World* was giving particulars of the well-known Ostar-Ganz valves, having the same object, with heaters up to 250 volts.



But as the title of this discussion names *British* technical progress I had better refrain from roping in various other parts of Europe.

Another novelty (in "The Art Advances") is the "wireless phonograph player." It consists of a small

Secondary emission valves were introduced here some time ago.

oscillator modulated by a pick-up, and tunable to any convenient point in the broadcast band, with the object of avoiding the need for any connecting line to the receiver. This interested me, because when I wrote about how to make such a device, 3½ years ago, the idea was already so old that I can no longer trace the original reference. Incidentally, it is amusing to note how even in details the traditional rôles have been exchanged—the American writer calls it "wireless"; the British, "radio."

But now we come to the *pièce de résistance*: "Of all the events of the year, the most eagerly awaited by the engineering public in the New York area was the

beginning of public television service." This is where our chests really do begin to swell up uncontrollably. In days gone by if we could anticipate our American friends by a few days in the matter of some trifle it was cause for self-congratulation. But to ante-date them in something of major importance—to put it mildly—by a margin of nearly three years—that is terrific! We have had our public television service just three years, which is

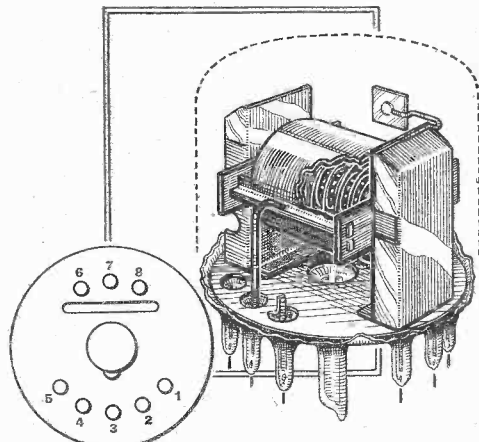

Has the time-honoured "pinch" form of valve construction outlived its usefulness? Sketch showing construction of a "footless" valve.

such a long time in radio chronology that it may not be realised that even from the first days it was considerably more of a service than can even yet be enjoyed anywhere in the States. Our regular programmes (demonstration film excluded) were never less than two hours a day for six days a week; which can be compared, or rather contrasted, with one hour a day for two or three days a week. Moreover, fifteen minutes is stated in American papers as the maximum length of any play or feature. We are fortunate in having full-length plays almost every day.

Costly American Televisors

One is so accustomed to expecting two things from specifications of new American sets—advanced design and incredibly low prices—that it is difficult to get over the novelty of finding the situation completely reversed. Let us make the most of this situation while we have it, just in case it won't last very long. The cheapest American television sets so far announced are close on £40 for table models with vision only (no sound) on 5in. cathode-ray tubes; large ones go over £100. So our own last season's list, including, for example, a sound-and-vision console model of advanced design

with a 9in. tube at £30 must make the New Yorker wonder how it is done, just as we have wondered in the past when looking through American catalogues. Most of the vision tubes, too, are long, electrostatic types, which are practically obsolete here.

Directions in which British television has a clear lead are large-screen projection apparatus, optico-mechanical methods and colour television. Even though America is the home of the iconoscope, we have it on no less authority than that of Mr. Gerald Cock that they have nothing yet to equal the super-emitter which has been used by the B.B.C. for nearly two years, and that the only department that seems in advance of ours is the telecine equipment.

Will America Catch Up?

All this is most distressing. The American radio papers are so preoccupied with the first fine careless rapture of embracing television that there is little room left for discussing things that might be new to us. Perhaps—dare I say it again?—it is only a temporary phase, and when they have caught up with us in television—as they certainly will very soon if we rest on our oars—a source of information on what we are going to do next will again be available.

Another thing: just think of the expense the B.B.C. would have been saved if they had had a model to copy! And think of all the troubles our manufacturers will have next season because nobody has shown them in advance what to avoid! Unless, of course, they mark time until new designs are once more tried out in the States. Well, one cannot have it both ways—safely and gloriously. It may be interesting to discuss later which you prefer.

It would be unjust to suggest that no pioneering at all is being done now in America. You will realise that I have been presenting a rather one-sided picture. For instance, there is a development that is really worth while, yet, unfortunately,

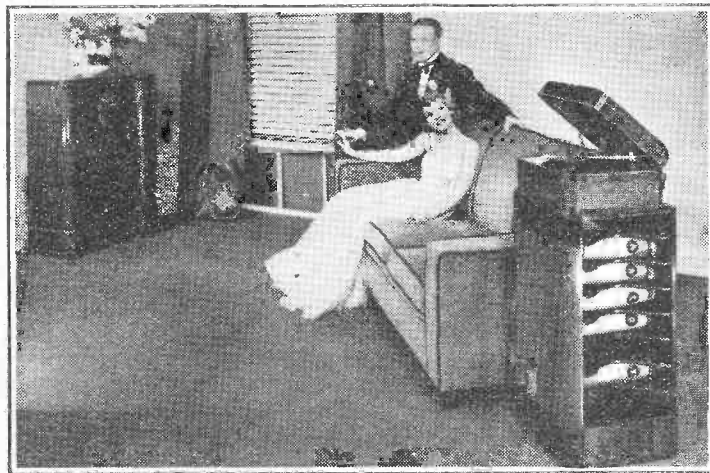

A "real wireless phonograph" from America. There is no tangible connection between the record reproducing equipment (right) and the wireless set.

there doesn't seem to be the ghost of a chance that we shall have it in the near

American Progress—and Ours—
future. I am referring to frequency modulation.

You are no doubt all painfully aware how limited is the range at which high-quality reception can be guaranteed at all times and in all places. That is true even if "high quality" is interpreted in an everyday commercial sense. But if it is understood to mean, for example, reproduction up to 15,000 c/s and complete inaudibility of such nuisances as electrical noise, atmospherics, other transmissions, etc., the range of even a modern 100 kW. transmitter is only a mile or two. Of course, that means that the vast majority of people are outside such range and have to put up with something less than the best.

Recent tests carried out in America seem to show conclusively that really high-quality noise-free reception can be obtained in unfavourable circumstances at much greater ranges and with lower transmitter powers than by conventional methods.

Random Radiations

"Diallist" Dug Out

HAVING unearthed his ancient Sam Browne belt (and having found to his horror, incidentally, that it had apparently shrunk by an altogether lamentable number of inches whilst laid up in lavender) your "Diallist" is writing these notes with his loins more or less girded in response to a telephone call, whose purport was "Report for duty at ——— by 09 hours to-morrow." The job assigned to him looks like being a pretty strenuous one; but as he will probably remain in the same locality for some little time, a small but effective "all-wave" receiver has been stuffed in amongst his kit and he hopes to be able both to use it and to jot down his notes as usual during such spare moments as may come his way. It will be interesting to see how many other members of the unit have followed his example and brought wireless sets; if any have done so, portables will probably have been their choice. In that case he will rise superior, for his receiver is not a portable, and it has no fewer than three short-wave ranges. If the aerial, when erected, should prove to be made of something bearing a close resemblance to telephone wire, it will be shown clearly that, whatever else he may have forgotten, he still retains something of the ancient military arts of "wangling" and "winning."

A Full Week

NEVER have I known such an amazing week on the short waves as that between August 22nd and 29th. Searching the world for news, you came upon a station giving a bulletin in one of the more comprehensible languages. You heard, may be, some rather striking item and were pondering over its possible implications as you moved to the next station. Having tuned this in, you lit upon the same item either flatly contradicted, or altered so as to have an entirely different significance.

And that prompts me to suggest that it ought to be possible to receive the Armstrong frequency modulation station here. If I had time I would certainly have a shot at it myself. There is ground for optimism in the fact that both sound and vision from the Alexandra Palace were logged almost every day during the winter of 1937-8 at Long Island, New York, where the field strength rose as high as 600 microvolts per metre. Now the Armstrong station is just between the sound and vision in frequency—42.8 Mc/s to be exact—and is transmitting considerably higher power. So there ought to be no difficulty in receiving a strong signal at times, using only an ordinary dipole-and-reflector aerial. Moreover, as the type of transmission gives an enormously improved signal/noise ratio, there is reason to hope for very good results. So who is going to be the first to receive the frequency modulation programmes in this country? I leave that as a parting suggestion to those who have a fancy for establishing records.

everything in the box. The contents, of the box, once useful odds and ends, were now mainly odd ends. To have salvaged and cleaned what was salvable would have been a repulsive business and I didn't try it. But don't tell me that dry cells can't be messy. Dead wasps can sting, so they tell me; so can dead dry cells.

Ever Use Headphones?

DO you ever use headphones nowadays? If you're not a professional operator I don't suppose you often do. I find a job of work for mine occasionally when I'm hunting for some distant and elusive station or when I want, if possible, to catch the call sign of some station from which no efforts of mine will produce more than a ghost of loud speaker volume. Except for communication receivers comparatively few sets nowadays have 'phone jacks; rather a pity, perhaps, because there's nothing to equal the plug and jack for making or unmaking connections quickly. You can, of course, make use of the extension loud speaker terminals, if they are fitted. Not a bad tip is to mount a jack on a small box containing a suitable output transformer, connecting the primary of the transformer by a pair of flex leads to the extra LS terminals. You can then plug in the phones when you want to. A switch for cutting out the loudspeaker is advisable.

Noisy Noises

At one time everyone had a pair of headphones and all wireless shops had big stocks of them at prices ranging from five shillings to three guineas. I believe that the development of the superhet into a popular receiver—the most popular now—put paid to the wide use of headphones even amongst DX enthusiasts. With its great sensitivity and big overall gain, the superhet makes loud speaker reception of a huge number of stations possible. It's certainly more comfortable to be able to work direct on to the loud speaker; 'phones do produce aches and pains in the top of one's head and the gristly bits of one's ears—and it's always rather a nuisance when you get up quickly from your chair and start to cross the room, forgetting that you are still yoked to the set by the 'phone leads! But there's another reason why the superhet helped to relegate 'phones to the bits and pieces cupboard, and that's noise. With phones you get the full benefit of hiss.

Local Effects

OF late there have been big thunderstorms all round the district in which I live, but so far (touch wood!) they have merely passed, rumbling and flashing, some distance to one side or the other of us. It's curious to notice how local they can be at times. The other afternoon I was using my wireless set a good deal on both the medium and the short waves, but noticed nothing very remarkable in the way of atmospherics. Certainly they weren't bad enough to make listening really unpleasant, let alone impossible. But that same evening, a friend who lives some seven miles away in a valley running parallel with mine told me on the telephone that they had had a bigish storm. If you'd asked me to guess from the atmospherics heard how near the storm had been, I'd have put it at many times that distance away. And yet sometimes you'll get great crashing X's from a very distant storm centre. Queer things, atmospherics.

By "DIALLIST"

Indispensable

Still, in critical times you just can't be without a wireless set—one with a short-wave range or ranges for choice. In the country, where such evening papers as we see are printed pretty early in London, we should have been sadly short of late news if we hadn't had the B.B.C.'s bulletins. And you can supplement them to a remarkable degree by spending a brief spell at the controls of the radio set. Looking over my log for the week before this note was written, I see that I collected news fairly regularly from France, Belgium, Sweden, Italy, Russia, Germany, the United States, Japan, China and various South American countries. I'm sure that there's nothing like a good wireless set for enabling you to do that. It gives you a feeling that you're in touch with things as they happen and not just a kind of aloof spectator.

Messiness

LOTS of people have written—I've done it myself often—that one of the strong points about the dry primary cell is its complete absence of messiness. But I found to my cost the other day that in certain circumstances these cells can be as messy as the wet ones. I wanted a bit of stout copper wire and remembered that I'd put some a good while previously into a box of odds and ends which reposed in a garden shed. Thither I repaired, and what a sight met my eyes! Someone (I don't think I was the offender) had lightly tossed a discarded bell cell into that box, where the thing had decayed—I can find no better word—with devastating results. The zinc can had either burst or become perforated and under the influence of warmth and damp a horrible corrosive stickiness had exuded over nearly

NEWS OF THE WEEK

DEFENCE REGULATIONS

Wireless Telegraph Communications

REGULATIONS issued under the Emergency Powers (Defence) Act have been published as a White Paper under the title Defence Regulations, 1939, by the Stationery Office, price one shilling.

Two regulations under Part I—"Provisions for the Security of the State"—relate to interference with and the control of wireless communications.

Regulation 2 reads: "No person shall knowingly (a) cause interference with the sending or receiving of communications by means of wireless telegraphy, wireless telephony or wireless television, or (b) cause interference with, or intercept, telegraphic or telephonic communications made otherwise than by the said means: Provided that the preceding provisions of this regulation shall not apply to anything done by or with the permission or under the direction of, any servant of His Majesty or constable acting in the course of his duty as such."

Controlling Communications

Under the section devoted to the control of means of communication, Regulation 8 states that the Postmaster-General may by order direct that, subject to any exemptions for which provision may be made by the order, no person shall, except under the authority of a written permit granted by such authority or person as may be specified in the order, have in his possession or under his control (a) any such article as may be specified in the order, being an article which is designed for the purpose only of being used for the operation of wireless transmitting apparatus; (b) any such wireless receiving apparatus as may be specified in the order, being a type of apparatus which is designed to be used also as wireless transmitting apparatus or which appears to the Postmaster-General to be readily adaptable for the purpose of being so used.

Subsection 2 states that the competent authority may by order provide for prohibiting in certain circumstances, and otherwise for regulating, the use of wireless transmitting apparatus; and if any apparatus is used in contravention of an order under this paragraph, then (without prejudice to any proceedings which may be taken against any other person) the occupier of the premises on which the apparatus is situated,

or, where the apparatus is on board any vessel or aircraft, the master of the vessel or the pilot of the aircraft, as the case may be, shall each be guilty of an offence against this regulation.

In accordance with Subsection 4, which reads: "Notwithstanding anything in Section 2 of the Wireless Telegraphy Act, 1904, the Postmaster-General in his discretion may refuse to grant a licence under the said section, and may revoke at any time a licence granted under that section," the P.M.G. announced last Thursday the withdrawal of licences for the establishment of:—

(a) Wireless telegraph sending and receiving stations for experimental purposes.

(b) Wireless telegraph receiving stations for experimental purposes and the use of wireless sending apparatus in conjunction with artificial aerials.

(c) Wireless telegraph sending and receiving stations for Royal Naval Wireless Auxiliary Reserve purposes.

FROM ALL QUARTERS

Bournemouth's Studio

ALTHOUGH Bournemouth has been deprived of its own broadcasting station since the opening of the Start Point transmitter, it now possesses its own studio and control room. The studio, which is in Majestic Chambers, Westover Road, was formally opened by the Mayor a few days ago. The output from the control room is fed to Bristol by Post Office land lines for distribution.

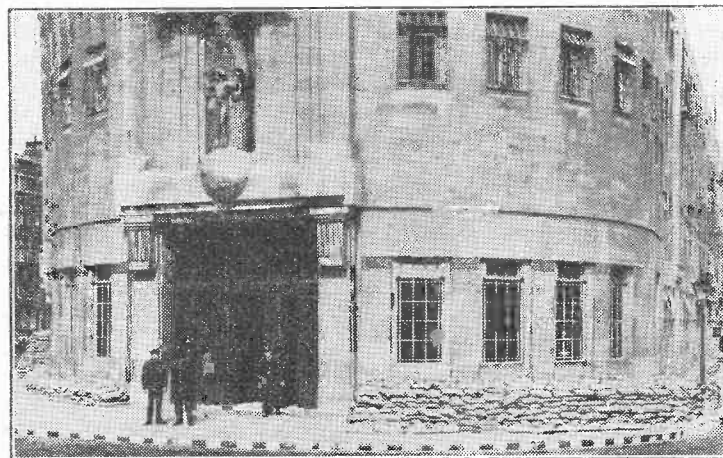

BROADCASTING HOUSE, LONDON. The continuance of broadcasting throughout the war is a vital factor and endless precautions have been taken at the headquarters of the B.B.C. to ensure this.

THE B.B.C.

"Broadcasting Carries On!"

THE slogan adopted by the B.B.C. at this critical time is "Broadcasting Carries On!" and, with this in mind, plans, laid many months ago, were brought into being by the B.B.C. at the outbreak of war to ensure a broadcasting service for the Country. London is no longer the centre of British broadcasting. Premises in the country have been taken over by the B.B.C., and from these will come most of the "live" programmes which will replace the recorded items heard during the past few days.

The Home Service, as the transmissions have been named, is, as is now so well known, broadcast on 391.1 metres (767 kc/s) and 449.1 metres (668 kc/s), the wavelengths assigned to the Scottish and North Regional transmitters.

With the publication of the supplementary issue of *The Radio Times* on Monday, it was learned that *World Radio* will be incorporated with *The Radio Times*.

Television

In an announcement broadcast by the B.B.C. last Friday it was stated that the television service would be discontinued until further notice.

Indian Listeners

THE total number of licences in force in British India at the end of June this year was 76,841. The increase for the first half of the year was 12,361, as compared with 4,739 for the same period last year. There were 18,117 sets imported into India during the half-year ending June, 1939.



H.R.H. THE DUKE OF KENT talking to Mr. A. F. Bulgin during his visit to Radiolympia, which closed abruptly last Friday morning. Between them is Mr. J. H. Williams, of Marconiphone.

B.B.C. Foreign Bulletins

A SHORT daily news bulletin in German, broadcast from the Droitwich National transmitter (1,500 metres) between 12.30 and 12.45 p.m. GMT, was introduced on Wednesday, August 30th. This, however, like the foreign-language news bulletins broadcast on the medium wavelengths, ceased with the inauguration of the "Home Service." The foreign news bulletins from the Empire short-wave station are continuing, with additional Afrikaans and German broadcasts.

Amateurs in South Africa

SOUTH AFRICAN radio amateurs are joining the South African Air Force Civilian Wireless Reserve.

New York's Third Television Station

THE Mutual Broadcasting System has applied to the Federal Communications Commission for a licence to operate a 10-kW television station in New York.

Television in Hollywood

PARAMOUNT PICTURES is erecting, in collaboration with the Don Lee television laboratories, a television station in Hollywood. It is understood that this station will transmit principally films.

New Spanish Station

THE Spanish Government proposes to erect a broadcasting station at Larache in Spanish Morocco. The transmitter will operate on 293.5 metres, with a probable power of 20 kW.

Broadcasting in Travancore

ONE hundred community receivers will be installed at all important villages and towns in the Travancore State in readiness for the opening of the new broadcasting station which is to be erected at a cost of Rs. 280,000.

UNBIASED

Rhodesian Rhapsody

I HAVE been having some technical correspondence during the past few weeks with a reader who has the good fortune to dwell in the wilds of far-away Rhodesia, free from all the cares and worries of this so-called civilisation. It is true that he is, as he has told me, sometimes troubled by marauding elephants roaming over his farm at night, but when he sees them he has at least the satisfaction of knowing that they are real flesh-and-blood elephants.

However, he does suffer from one great disadvantage, and that is the inability to get his LT battery charged, as the local radio shop is apparently a few hundred miles away. HT is a problem, too, although if the LT problem could be settled really satisfactorily, that would disappear, as he would naturally use a vibrator for his source of HT supply.

I was deeply engaged in considering his problem the other evening, and must, in my profound meditation, have unknowingly started muttering aloud, as Mrs. Free Grid looked up from her knitting and demanded to know who Maggie was, and it took me two solid hours to convince her that it was merely the pet name with which we old-timers used to designate the magnetic detector which I had momentarily considered as a possible solution to my correspondent's problem.

In the hope that the much-vaunted "woman's intuition" would solve the problem, I told her of my correspondent's troubles, explaining carefully that he was not connected to the electric lighting mains, and that it was, therefore, useless for her to suggest an all-mains set as a means whereby he could get rid of his battery troubles. She was nothing daunted, however, and, emulating the historic example of Marie Antoinette, said rather tartly that if he were so behind the

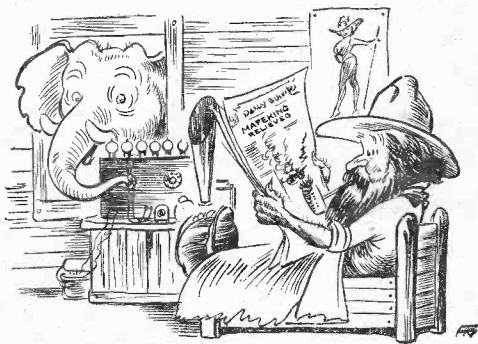

Where news percolates slowly.

times as not to have the electric light laid on, he must use the gas mains.

I somewhat wearily explained to her that even here in England the gas mains were not of much avail for running a wireless set, and almost immediately, as if to

believe my words, there was a knock at the door, and a railway vanman staggered in with one of the new gas-operated wireless receivers which the Editor had sent to me for my opinion. I am afraid that as a result of this unfortunate contretemps I have definitely lost technical caste in Mrs. Free Grid's eyes, and am quite unable to convince her that it would not be a good thing for my Rhodesian correspondent to install one of these sets and have gas sent out to him in cylinders in order to operate it.

Esau Up-to-date

I TRUST that you will excuse my somewhat unkempt appearance this week, but, as I mentioned briefly last week, I am in the throes of struggling with an electric razor, and, although I have high hopes for next week, I have not yet got to that schoolgirl complexion stage which the makers of the razor have promised me will be the reward of perseverance. Obviously, as a keen wireless and electrical man I could not ignore this latest example of the electrical engineer's art, and have flung away my old-fashioned soap and razors, and am now sharing the lot of all pioneers. I may not look too good just now, but wait until next week or the week after, and I shall have the laugh on all you musty old Victorians with your old-fashioned gashers and scrapers.

To be quite honest, the real reason why I got hold of one of these devices was because I had read such a lot in *The Wireless World* correspondence columns about the ease with which they could be "suppressed" by a simple condenser, and I wished to experiment for myself. When I sent Mrs. Free Grid off to London to get me one I had not the slightest intention of using it on my own face, but was intending to experiment on a pestilential Pekingese which has been introduced into my household. When Mrs. Free Grid arrived back from town she was in high glee, and put the package containing the razor on my desk triumphantly, and stood obviously waiting for my approval, as though she were a child who had just performed some clever trick.

Feeling somewhat suspicious and uneasy, I slowly opened the package and found that she had brought what I believe is the one and only razor on the market which is "suppressed" by its makers. She would! Before I had time to protest, she commenced to explain how she had ransacked half the shops in London before she had found a razor fitted with a suppressor, as she knew that I would be very particular on this point.

You will readily understand that since the thing was already suppressed my *casus experimenti* was gone, and there was simply no use to which I could put it other than to employ it for the purpose

By FREE GRID

for which it was designed, namely, shaving my face. The first morning I fared very badly indeed, as I forgot that I was not using an ordinary razor, and absent-mindedly dipped it into the hot water. As I happened to have my other hand on the earthed tap at the time I was brought out of my reverie somewhat abruptly, and in addition, had to spend the whole of the day taking the thing to pieces and carefully drying-out the motor.

At present my face is rather like the curate's egg, as it is a bit patchy, but I must admit that this is only what the makers' instructional booklet told me to expect for the first week, and so, having

The lot of all pioneers.



found the book of words to be accurate so far, I am looking forward confidently to the schoolgirl complexion which the book promises me next week.

Surprise Item

DURING the course of the exhibition I left my card at several stands with a request that certain sets which took my fancy should be sent down to me for test. I had quite overlooked the fact that several wireless manufacturers nowadays make other electrical goods as well as wireless sets, with the result that my garden is at present cluttered up with a miscellaneous collection of refrigerators, vacuum cleaners and similar electrical impedimenta. I must, however, pay a tribute to the members of the despatch department of one big firm. They really have sent a wireless set, but it is the wrong model, of course.

Actually this particular set is one which I do not recollect seeing at the show. It is a motor-tuned push-button set and has one of the buttons labelled "surprise item." By means of an ingenious device, matters are so arranged that each time you press the button you get a different station. Moreover, you don't get the various stations one after another in a regular rota. This button is therefore well and truly named, as when you push it you never know what station you are going to get.

Olympia Conventions

TECHNICAL MEETINGS AT THE SHOW

British Technical Progress

Some Comparisons with America

At the first day's meeting of the Convention, Mr. M. G. Scroggie, B.Sc., A.M.I.E.E., a consulting radio engineer, introduced by Major L. H. Peter (a Vice-President of the R.M.A.), the Chairman, opened the discussion. His remarks are reported at length elsewhere in this issue.

The next speaker, Mr. T. E. Goldup, A.M.I.E.E., of Mullard's, said that valve development had run along two different tracks here and in the U.S.A. Here, the trend had been to cram as many valves into one "envelope" as possible, and to make the valves highly efficient. This resulted in valves being individually dear, and thus there was a tendency to design a set to use as few valves—or "envelopes"—as possible in order to cheapen the set. In America, however, the tendency had been to design sets to use as many valves as possible, because the valves were cheap, of low efficiency and were "simple," i.e., one valve in each envelope. He did not express an opinion as to whether the American or the British method was the better of the two; both had dictated by particular circumstances existing in the two countries, but he claimed that the British system had resulted in the production of much more efficient valves.

Mr. G. Parr, of Ediswan's, who followed, compared British and American television, first dealing with the development of ordinary sound broadcasting, which in America had had about two years start, and had kept it ever since. But in the matter of television, it was this country that had had the start, and it was up to us to keep it. He drew particular attention to the way in which television had served to develop the cathode-ray tube. He said that, so far as he could recall, development had been more rapid than had that of any other electrical device. For a long time the cathode-ray tube existed in a crude state. It was a "soft" tube with a useful life of not much more than 24 hours. Under pressure of the demands of television it had been developed from this stage to a more or less perfected state in not much more than a year.

Television: The Position in America

He said also that in spite of it being the home of the Iconoscope, America was still very much behind this country in the matter of television transmission and reception. They were still in the "electrostatic" receiving tube stage, whereas we had advanced fully to the "magnetic" stage. In general, the only television gear in which the U.S.A. had the lead was the apparatus for showing television in the cinema. Apart from being inferior in performance, television sets in the U.S.A. were much dearer than over here, and were likely to remain so for some time to come. In America the tendency was to use films instead of direct transmission. He attri-

buted this to the fact that here the money for programmes was obtained from licences, whereas in the U.S.A. it was derived—or at any rate going to be derived—from advertisers. They preferred that their sponsored programmes—and more especially plays—should be on film, because it was possible to prepare film programmes with infinite care, shooting a scene over and over again until it was entirely satisfactory, as is done in the case of ordinary cinema films. The result was a finished and polished performance, greatly superior to what the Americans claimed must be obtainable from "direct" transmission, because in the case of "direct" transmissions the plays, etc., were likely to be insufficiently rehearsed. Furthermore, the advertiser sponsoring the programme was able to see the trial film and approve of it before it went on the air.

The meeting was then thrown open to general discussion, and one of the speakers protested against the growing idea that American apparatus was always best, and always in advance of the British product. He also asked why manufacturers did not produce for battery users 2-volt indirectly heated valves with the cathode brought out to a separate lead. The amateur transmitter's demand for more and cheaper transmitting valves was also voiced.

Quality Reproduction

What It Means To-day

THE Chairman, Mr. Leslie McMichael, in welcoming the audience at the second meeting on behalf of the R.M.A., spoke of the advances in receiver design since the beginning of broadcasting. In no direction had greater strides been made than in quality of reproduction.

Mr. P. G. A. Voigt, B.Sc., A.M.I.E.E., of Voigt Patents, Ltd., set himself the task of defining good-quality reproduction and opened his argument by pointing out that quality had different meanings for different people. He recalled many years ago listening to the distorted speech from an aerodrome transmitter and the almost unintelligible reply from an aeroplane, which was nevertheless acknowledged as "O.K." by the recipient. Subjective opinion was clearly unreliable since it had been continually revised and remoulded by technical progress.

It had been suggested that the perfect reproducer might be one which would create the impression that the Queen's Hall orchestra was actually in the room. This was an ideal which could not be realised, for the echo pattern of the listening room would be added to that of the Queen's Hall.

AN OLYMPIA "SIDESHOW"

Dual-controlled transmitters and receivers such as that shown on the R.A.F. stand at Olympia are used in Army co-operation planes. The two-valve master-oscillator-controlled transmitter, which works on telephony, CW and ICW, employs grid-modulation for telephony. The HT supply is interrupted for ICW. The transmitter can be used either on the 250-ft. trailing aerial or the 12-ft. fore-and-aft fixed aerial. The complementary receiver employs a 5-valve straight circuit with a separate one-valve oscillator for CW. All the controls are in duplicate.

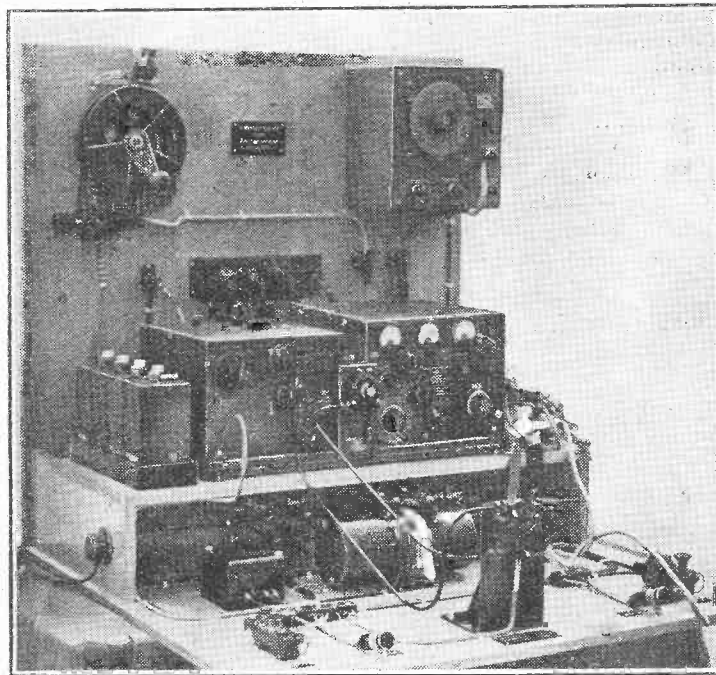

British components were unfavourably compared with American by another speaker. American switches, he said, were greatly superior to ours. British sets used switches for wave-changing long before the Americans, but in spite of this our products are now far behind the Americans in the matter of reliability. He hoped that television would not go the same way.

In reply, Mr. Parr strongly defended the superiority of British goods. American apparatus was only superior to our products on the surface.

All that we could reasonably ask of a loud speaker was that it should reproduce the same effect as one would get if a replica of the listening room were built on the floor of the Queen's Hall (assuming permission could be obtained from Messrs. Chappell) and the concert were listened to through a hole in the wall of the same size and in the same position as the mouth of the loud speaker. When judging the loud speaker, one should keep this picture in mind; if there were not the illusion that one could walk to the window in the listening room

Olympia Conventions—

and congratulate the performers in the large hall outside, then there must be some defect in the electro-mechanical link between studio and listener.

To show what a near approach to this ideal is possible, Mr. Voigt arranged a demonstration of sounds rich in transients, such as bells, the hammering of nails and the sawing of wood. The reproducers were two corner-horn loud speakers placed back to back, and the sounds were picked up by a microphone in an adjoining room. In an earlier demonstration the presence of an electric motor horn in front of the loud speakers deceived many of the audience. Not until it was disconnected and removed did they realise that the sound was coming via the microphone and loud speakers.

By means of a selection of gramophone records, Mr. Voigt also demonstrated the effects of different degrees of reverberation. One record of a trumpet made at a distance of four inches from the microphone, thus consisting almost entirely of direct sound, was particularly realistic. The demonstration as a whole was warmly applauded by the audience.

The second speaker was Mr. A. B. Calkin, M.A., A.M.I.E.E. (Philips Lamps, Ltd.), who pointed out that the standpoint of the set manufacturer was fundamentally different from that of the quality enthusiast. Whereas the latter was quite prepared to sacrifice range, selectivity, and even appearance to quality, the manufacturer of sets for general sale had to keep in mind five principal requirements: (1) appearance; (2) range; (3) selectivity; (4) quality; (5) volume. It was his experience that if any one of these attributes were developed at the expense of the others, the set was hard to sell; the most popular models were those with a balanced performance.

That was not to say that progress in quality had not been made. Recent advances in modern sets included reduction of amplitude distortion, straightening of overall response curves, removal of cabinet resonances and the prevention of focusing of high frequencies. In fact, receivers of the £15-£20 class provided sufficiently natural reproduction for all reasonable requirements. He had doubts as to whether the ordinary listener appreciated the standard of quality given by modern sets, for the service department reported that the majority of receivers returned for investigation were found to have the tone control in the extreme "mellow" position.

Wanted: New Power Output Rating

Speaking of the difficulties of expressing quality and volume in terms which had any real meaning, he explained the inadequacy of the customary wattage rating. This did not state where the power was measured (cross primary or secondary of the output transformer), neither did it take into account the electro-acoustic efficiency of the loud speaker. So many conflicting factors were involved that a new unit seemed to be called for.

Another problem for the set manufacturer was to decide at what volume level the set should give the best quality. Mr. Hughes had recently pointed out in *The Wireless World* that even in the concert hall the distance of the listener from the orchestra affects the tonal balance of what he actually hears. Should one compensate on the assumption that the purchaser always tries for a seat in the front stalls, or are there many who prefer the balance at the back of

the hall? Since it was a matter of personal preference, tone control must be provided. The brightening effect of an excess of treble compensation was found to be acceptable. Similar compensation in the bass could be arranged but was expensive. In general it was unnecessary if the response could be maintained down to 70 cycles without serious falling off.

Summarising the position from the point of view of the set maker, Mr. Calkin concluded: (1) that although quality of reproduction is important, it cannot be allowed to account for too high a proportion of the cost. (2) Variable selectivity was indispensable to a satisfactory compromise between quality and other functions of the receiver. (3) "Fake" tone compensation was justified if it satisfied the "discriminating listener." (4) That while there was still room for further improvement in cabinet design, the reduction of harmonic distortion and better control of frequency response, any radical advance, apart from binaural reproduction, was not to be anticipated.

Mr. G. A. V. Sowter, B.Sc.(Eng.), A.M.I.E.E. (Telegraph Construction and Maintenance Co., Ltd.), was of opinion that there was considerable room for improvement in commercially produced loud

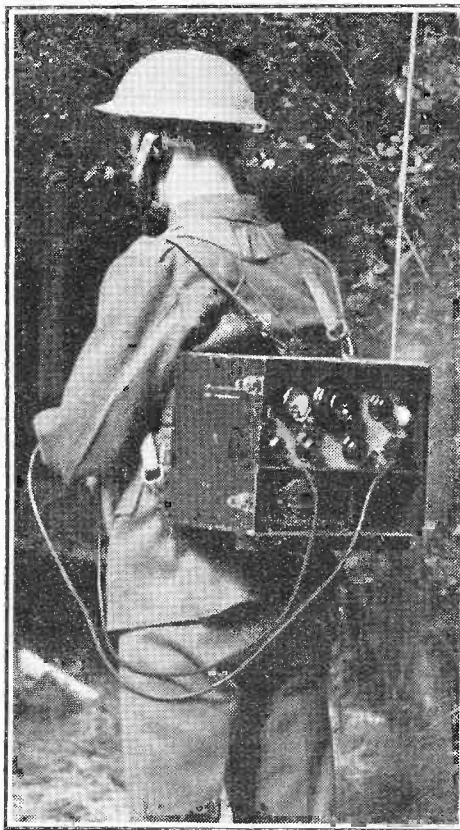

Telephony and telegraphy communication between battalion and company headquarters is provided by this pack transmitter-receiver which was an interesting exhibit on the Royal Corps of Signals stand at Olympia. Working on an 8-ft. sectional aerial, which, when not in use, stows away in the lid of the case, it has an effective range of three miles. This latest acquisition of Royal Signals, which weighs 28 lb. and is made by Marconi, is still in its experimental stage.

speakers. Manufacturers seemed loth to avail themselves of the accumulated design data already available, and it was not to be wondered at that little fundamental research was being done since they were not prepared to pay for a product of higher quality. He thought they were content to cater for the

"standard" ear rather than the "discriminating" ear.

He was sorry to note the disappearance of the baffle, though he appreciated the strength of domestic influences. In cabinet design appearance seemed to be given precedence over acoustic requirements.

The set alone was not entirely to blame for faulty reproduction. Response curves of a loud speaker taken in an ordinary room might show deviations of as much as 20 db. compared with the same loud speaker when measured in a sound absorbing room. The selection and arrangement of the listening room should receive as much care as the choice of a loud speaker.

Output Transformer Distortion

Dealing with the subject of harmonic distortion, Mr. Sowter drew attention to need for careful design of the output transformer and referred to the recent work on iron core distortion by Mr. N. Partridge. The use of nickel-iron alloys in place of the more usual silicon-iron pointed to a satisfactory solution of this problem.

The Chairman then declared the convention open for general discussion. Dr. G. F. Dutton (Electric and Musical Industries, Ltd.) was the first speaker and he drew attention to the disturbing qualities of background hiss and "man-made static." There was biological reasoning to support this fact, for in the animal world high-pitched sounds were usually signals of danger and produced an unpleasant reaction. When used as a background for other activities broadcast music called for a cut in top, but high-fidelity reproduction was acceptable when one concentrated on the matter being broadcast.

It was permissible to change the balance of tone for different types of transmission. Dance music, for instance, called for a good bass response to convey the foundation of rhythm. In some cases tone correction would be better if introduced at the transmitting end.

With regard to the adjustment of room characteristics, if damping materials were gradually reduced until the quality of speech sounded natural, the reverberation period thus achieved would be a good average for other types of programme.

He hoped that advantage would be taken of ultra-short waves to transmit binaural or multi-channel sound, but special receivers would be necessary.

Mr. Barden (Goodmans Industries, Ltd.) could not agree that loud speaker manufacturers were neglecting to use new developments in design. Better loud speakers were always available to the set manufacturer, but so far the demand for cheap units was the greater.

Mr. A. K. Webb (Murphy Radio) thought there was no need to go above 8,000 c/s in a broadcast receiver and that a sharper cut-off at this frequency could be obtained by a single curved-sided cone. The quality of such a loud speaker was sufficiently good to show up differences in the B.B.C. transmissions.

Mr. Sowter thought the public could be educated in the proper use of tone controls. The controls and dials of the modern aeroplane cockpit would have hopelessly confused the pilot of 10 years ago, but were taken as a matter of course by the young man of to-day. He thought that if the public were more persistent and were prepared to pay, they could have much better quality of reproduction than they were getting.

Olympia Conventions—

Mr. Voigt thought there was no need for additional lifting of top. In most of their transmissions the B.B.C. were already doing this and he found it necessary to use a filter for really high quality. The B.B.C. control engineer should be provided with a tone control independent of the line correction circuits and a monitoring speaker which really hurt the ears when an excess of top was allowed to pass to the transmitter.

With regard to the effect of room characteristics, the strength of walls had a profound influence on balance. In modern houses the walls were porous to very low frequencies and there was an excess of top in the response. In solidly built ancestral homes, heavy furnishings such as carpets and tapestries absorbed top and gave a preponderance of bass.

Dealing with the question of binaural listening and the suggestion of one speaker that this could be provided by a single channel, he thought that true binaural listening would always require two channels, but that there were possibilities for experiment in alternating between two microphones at different distances from the source and at places with different echo characteristics.

Short Waves

Circuits and Valves

THE third meeting was held under the chairmanship of Mr. E. M. Lee, Chairman of the R.M.A. Technical Advisory Committee. Dr. R. C. G. Williams, A.C.G.I., D.I.C., Ph.D.(Eng.), of Murphy Radio, opened by giving a brief résumé of the methods by which short waves are propagated, emphasising that the indirect ray, via the reflecting layers of the upper atmosphere is all-important in this branch of our art. He then went on to deal with the intermediate frequency of superheterodynes, explaining why the value of 110 to 120 kc/s, used in the days of 2-band receivers, is not suitable for the modern "all-wave" set. Considerations leading up to the choice of the present-day frequency of about 465 kc/s were discussed at length.

Dr. Williams then proceeded to describe the design of the short-wave side of specific receivers, explaining the importance of band-spreading in overcoming tuning difficulties. He discussed the design of the Murphy A36 receiver, with its double frequency changing, and showed how the rather costly second frequency changer has been eliminated in later models. Present methods of using the ordinary tuner as the band-spreader were described. Fading, which remains the principal obstacle in short-wave broadcasting, is being partly overcome by improvements at the receiving end, but chiefly by the intensive development of short-wave anti-fading aerials. For this we have to thank the present international situation, which thus is responsible for at least one good thing.

Mr. L. A. Moxon, also of Murphy Radio, opened the subsequent discussion by dealing with some of the practical details of short-wave developments. He then turned to the important subject of valve noise, putting forward the simplified formula:

$$\text{Noise level} = \frac{\text{Mutual Conductance}}{\sqrt{\text{anode current}}}$$

This, he said, was a rough-and-ready formula that might not be acceptable to the "highbrows," but which was found to work

out very well in practice; it had a certain amount of solid scientific backing. The formula showed plainly that we must have high-slope valves, and, thanks largely to television, we have got them.

The second part of the proceedings, devoted to the subject of valves for short-wave work, was opened by Mr. F. E. Henderson, A.M.I.E.E., of the G.E.C. He said that the main troubles connected with valves for short-wave work could be summed up in the phrase "input impedance." This quality depends on the transit time of electrons and on the length of cathode lead. Both cause such severe damping of the input circuit that it was not worth while for the circuit designer to do anything towards reducing losses in his sphere until valve makers tackled the problem. This they have done by reducing spacing between electrodes inside the valve and redesigning the foot and "pinch" of the valve. Figures for the improvements recently effected were given.

Short-wave frequency changing

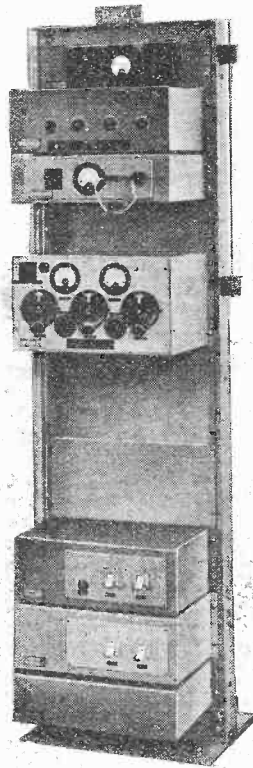

Visitors to the G.P.O. stand at Radiolympia were able to speak to one another by means of short-wave radio-telephone receivers, one of which is shown here. Similar to those in use for the telephone services between the mainland and outlying islands, they worked on a wavelength of 4.4 metres.

was another important subject discussed by Mr. Henderson. He illustrated the shortcomings of some of the earlier frequency changing valves, and explained how these difficulties have been overcome by the development of a new type of triode-hexode, the X65. Methods of overcoming frequency drift were also discussed.

Mr. Watson Watt wound up the meeting with a speech in which he urged valve and set makers to turn their attention to the 2-3-metre band with the same energy they had applied to 5 and 7 metres.

A report of the last meeting of the convention, which dealt with Television, will appear in our next issue.

VOLTAGE-DROPPING RESISTANCES

Possible Dangers—and a Remedy

IN the letter reprinted below, which appeared recently in the *Electrical Review*, attention is drawn to the risk of fire introduced by resistor cords used for absorbing surplus mains voltage in midget AC/DC receivers.

"For the third time in five weeks I have

been called in to attend to fire damage caused by American 'midget' AC-DC radio receivers. These sets are made for use on a 110-V supply, and their use on a 200-250-V supply necessitates a resistance to reduce the mains voltage.

"Until recently many of them were equipped with a two-core resistor cord, wired in series with the heaters of the valves, the idea being that as the resulting heat was dissipated along a relatively long cord, it was safer than utilising a small wire-wound resistance inside the cabinet. This arrangement has now been discarded by American manufacturers in favour of compact 'resistor tubes,' resembling receiving valves, mounted on the chassis.

"The danger arises when a short-circuit takes place at the low-potential end of the resistor cord. The resistance wire is wound on a few strands of asbestos, and is enclosed by a thin layer of the same material wound spirally over it. This resistance element is enveloped in the same outer covering as the other stranded flexible conductor, and where it passes through the (usually) unbushed hole in the metal chassis, the rubber insulation often becomes defective, and the two conductors come into contact. As the resistance is fairly high, even a light fuse will not blow as a result of the fault, but instead the resistance wire becomes red-hot, and remains in this state for a considerable time—until the two conductors touch near the wall socket outlet. I have seen many scorched and burnt carpets from this cause, and two more or less serious fires.

"The prevalent custom of fixing switch sockets in the most inaccessible position on the skirting, usually under the table supporting the wireless set, provides a big temptation to the user to turn off the set with the small switch on the receiver. He or she can hardly be expected to grovel on the floor to switch off the radio, and in most cases the cord is left alive.

"The remedy is quite simple. If the switch terminals on the set are short-circuited, and a switch socket is fixed on the wall beside the set, it cannot be left in an unsafe condition. Portable electric fires are now fitted with a 'live' bar, controllable only from the switch socket, and it is even more important to ensure that these makeshift resistor cords are not left alive.

Edgware. JOHN BLAND."

The Wireless Industry

A LEAFLET describing the Premax "Rotamount," a universal turntable for supporting beam aerial arrays, will be sent to interested readers by Holiday and Hemmendinger, Ltd., 74-78, Hardman Street, Manchester, 3.

The new "Osram Valve Guide" is now available. It includes details of the new "Minwatt" range, a number of circuits illustrating the application of valves of different types in modern sets, and full technical details of all Osram transmitting and receiving valves.

A new catalogue of aerial equipment for broadcast reception, television and car radio has been received from Aerialite, Ltd., Castle Works, Stalybridge.

List No. 162, the 1939-40 catalogue of Bulgin radio products, is now available, and may be obtained, price 3d., from A. F. Bulgin and Co., Ltd., Abbey Road, Barking.

Recent Inventions

TUNING INDICATORS

As shown, a small glow lamp L for illuminating the indicator scale S is mounted inside the hollow part of the main tuning-knob K. An aperture A allows the light to shine upon the part of the scale near the indicator needle N, as the latter is rotated by the knob. The aperture may be covered by a strip M of coloured glass.

Where several control knobs are used for different purposes, each may be similarly fitted with an illuminating lamp for the associated dial. The advantage of the arrangement is that the lamp is

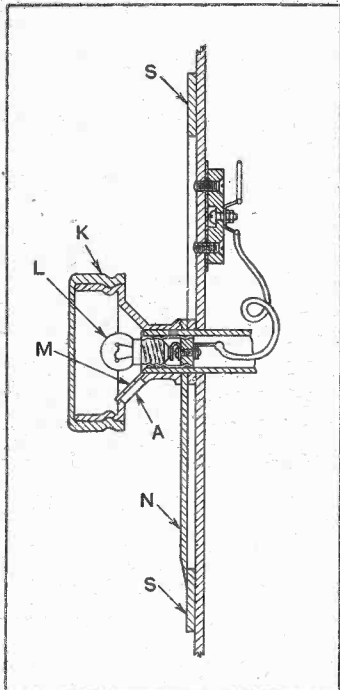

Dial light mounted in tuning knob.

centrally situated and takes up no valuable space. It is particularly suitable in cases where diffused illumination is required, as, for instance, in flying by night.

Telefunken Gesellschaft für drahtlose Telegraphie m.b.h. Convention date (Germany), October 20th, 1937. No. 504190.

TELEVISION TRANSMITTERS

The image of a picture to be televised is focused on to one face of a double-sided mosaic screen mounted inside a cathode-ray tube. The screen is preferably made of a mesh of insulated wires, the interstices being filled with silver "rivets," which are visible on both sides and coated with caesium. The face of the screen on which the image is projected is scanned by a stream of electrons from the gun of the cathode-ray tube. Each mosaic cell of the screen then emits electrons towards an adjacent ring electrode, which is kept at a fixed potential.

The other face of the screen is independently scanned by an intense beam of light, which again causes electrons from each mosaic

Brief descriptions of the more interesting radio devices and improvements issued as patents will be included in this section.

to fall on to a second ring electrode, also kept at a fixed potential. During the interval between successive scanings, each mosaic cell builds up an individual charge equivalent to the light intensity of the corresponding part of the original picture. The sudden change of potential, brought about by the two scanning operations, liberates from each mosaic cell a signal voltage representative of that particular part of the picture.

Scophony Ltd.; G. Wikkenhauser; and A. F. H. Thomson. Application date February 3rd, 1938. No. 504668.

SCANNING AND DISTORTION

As it passes through the focusing fields, the scanning stream of electrons in a cathode-ray tube is liable to be distorted, so that it is no longer circular in cross-section, thus producing a distortion effect which can be described as "astigmatic."

In order to prevent this, it is proposed deliberately to deform the stream at a point before it enters the distorting field, so that, when it emerges, it will be restored in shape, and produce a perfectly circular "spot" on the fluorescent screen. The required degree of "pre-distortion" is applied by a strip of magnetic material, which is inserted outside the neck of the cathode-ray tube, and near the magnetic focusing coil. The strip is carried by a split ring of phosphor bronze which can be rotated, relatively to the tube, until it produces the effect desired.

Ferranti Ltd. and M. K. Taylor. Application date December 28th, 1937. No. 506933.

U.S.W. RECEIVERS

The drawing shows a magnetron valve M arranged for the reception of very short waves.

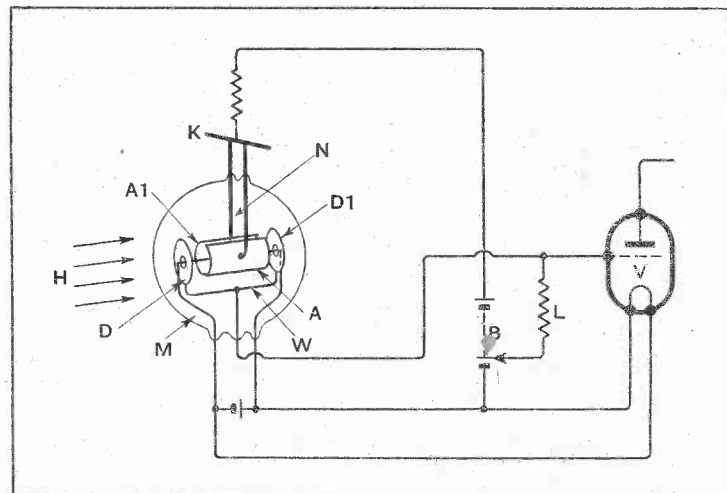

Magnetron valve circuit for stable U.S.W. reception.

The two halves A, A1 of the "split" anode are connected through a Lecher-wire circuit N to the receiving aerial K, and are positively biased by the battery B. A magnetic field H is applied to the electrodes from an external winding, which is not shown in the sketch.

Usually the rectified signal voltage is developed across a suitable impedance inserted in series with the anode circuit. It is found, however, that this involves a constant "shifting" of the working point along the characteristic curve, owing to variations of the valve impedances, both internal and external.

According to the invention this difficulty is overcome, and the operation of the valve is stabilised by providing two discs D, D1, one at each end of the cylindrical anode. The discs are connected together by a wire W, and are also connected through a load impedance L to a tapping on the battery B. The current collected by the discs, and flowing through the load L to the cathode, then carries a rectified component of the incoming signal, similar to that usually produced in the anode circuit. The new arrangement allows the signal voltage across L to be applied directly to a subsequent amplifier V, as shown.

Telefunken Gesellschaft für drahtlose Telegraphie m.b.h. Convention date (Germany) July 14th, 1936. No. 501048.

LOUD SPEAKER IMPROVEMENT

The modern type of flexible diaphragm is designed to do justice to the lower frequencies, but has so little natural stiffness or rigidity that it tends, when the loud speaker is mounted vertically, to "flop over" to one side or other. This displaces the speech-coil in the air-gap, so that

it is no longer perfectly symmetrical.

The use of springs to correct this fault has not been favoured because it was thought that they must inevitably prevent the proper free movement of the speech coil. It has now been found, however, that this need not be so, provided the spring is made sufficiently long. If this be done, it does not contribute to the con-

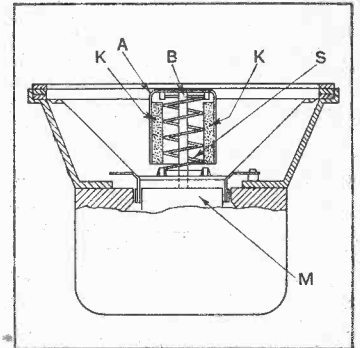

Spring-balanced LS diaphragm.

trolling force of the magnetic field, nor increase the resonance frequency of the diaphragm.

As shown in the figure, the spring S is suspended from a bolt B inserted in the centre pole-piece of the magnet M, and is enclosed in a box A fitted with damping strips K of felt. It then serves to balance the weight of the diaphragm without prejudice to its free response to the AF input.

Telefunken Ges. für drahtlose Telegraphie m.b.h. Convention date (Germany) October 22nd, 1937. No. 505964.

ETHERIC "WATCHDOG" DEVICE

It is sometimes convenient to know what transmissions are taking place, at any given time, over a certain range of wavelengths. The invention provides what may be termed a "watchdog" device, which constantly supervises the whole of a given band of frequencies and shows what stations are operating, and on what wavelength.

A motor drives a rotating switch in order to vary the tuning of the aerial circuit, at a fairly high speed, over the whole of the band of waves under survey. Any carrier wave that is picked up then operates one of a number of glow-lamp indicators which are arranged alongside a scale graduated in wavelengths, so that each station can be identified.

G. de Monge. Application date, September 1st, 1938. No. 506133.

The British abstracts published here are prepared with the permission of the Controller of H.M. Stationery Office, from specifications obtainable at the Patent Office, 25, Southampton Buildings, London, W.C.2, price 1/- each.

CLASSIFIED ADVERTISEMENTS

NOTICES

THE CHARGE FOR ADVERTISEMENTS in these columns is 12 words or less, 3/- and 3d. for every additional word.

Each paragraph is charged separately and name and address must be counted.

SERIES DISCOUNTS are allowed to Trade Advertisers as follows on orders for consecutive insertions, provided a contract is placed in advance, and in the absence of fresh instructions the entire "copy" is repeated from the previous issue: 13 consecutive insertions 5%, 26 consecutive, 10%; 52 consecutive, 15%.

ADVERTISEMENTS for these columns are accepted up to **FIRST POST** on **MONDAY MORNING** (previous to date of issue) at the Head Offices of "The Wireless World," Dorset House, Stamford Street, London, S.E.1, or on **SATURDAY MORNING** at the Branch Offices, 8-10, Corporation Street, Coventry; Guildhall Buildings, Navigation Street, Birmingham, 2; 260, Deansgate, Manchester, 3; 26b, Renfield Street, Glasgow, C.2.

Advertisements that arrive too late for a particular issue will automatically be inserted in the following issue unless accompanied by instructions to the contrary. All advertisements in this section must be strictly prepaid.

The proprietors retain the right to refuse or withdraw advertisements at their discretion.

Postal Orders and Cheques sent in payment for advertisements should be made payable to **LIFFE & SONS Ltd.**, and crossed **& Co.** Notes being untraceable if lost in transit should not be sent as remittances.

All letters relating to advertisements should quote the number which is printed at the end of each advertisement and the date of the issue in which it appeared.

The proprietors are not responsible for clerical or printers' errors, although every care is taken to avoid mistakes.

NUMBERED ADDRESSES

For the convenience of private advertisers, letters may be addressed to numbers at "The Wireless World" Office. When this is desired, the sum of 6d. to defray the cost of registration and to cover postage on replies must be added to the advertisement charge, which must include the words Box 000, c/o "The Wireless World." All replies should be addressed to the Box number shown in the advertisement, c/o "The Wireless World," Dorset House, Stamford Street, London, S.E.1. Readers who reply to Box No. advertisements are warned against sending remittances through the post except in registered envelopes: in all such cases the use of the Deposit System is recommended, and the envelope should be clearly marked "Deposit Department."

DEPOSIT SYSTEM

Readers who hesitate to send money to advertisers in these columns may deal in perfect safety by availing themselves of our Deposit System. If the money be deposited with "The Wireless World," both parties are advised of its receipt.

The time allowed for decision is three days, counting from receipt of goods, after which period, if buyer decides not to retain goods, they must be returned to sender. If a sale is effected, buyer instructs us to remit amount to seller, but if not, seller instructs us to return amount to depositor. Carriage is paid by the buyer, but in the event of no sale, and subject to there being no different arrangement between buyer and seller, each pays carriage one way. The seller takes the risk of loss or damage in transit, for which we take no responsibility. For all transactions up to £10, a deposit fee of 1/- is charged; on transactions over £10 and under £50, the fee is 2/6; over £50, 5/-. All deposit matters are dealt with at Dorset House, Stamford Street, London, S.E.1, and cheques and money orders should be made payable to Liffe & Sons Limited.

SPECIAL NOTE.—Readers who reply to advertisements and receive no answer to their enquiries are requested to regard the silence as an indication that the goods advertised have already been disposed of. Advertisers often receive so many enquiries that it is quite impossible to reply to each one by post. When sending remittances direct to an advertiser, stamp for return should also be included for use in the event of the application proving unsuccessful.

ARMSTRONG QUALITY YEAR SUPERHET - STRAIGHT 10 - VALVE ALL-WAVE HIGH FIDELITY RADIOGRAM. MODEL SS10

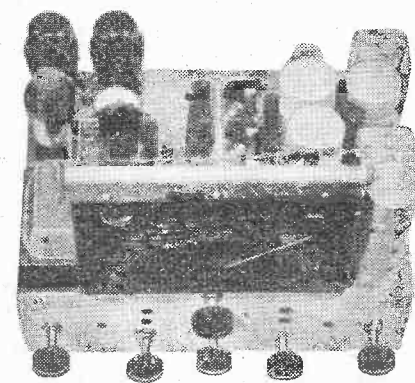

The circuit of the SS10 is unique. When used as a STRAIGHT receiver two HF stages are in operation with A.V.C. Diode Detector is used for distortionless detection together with Triode Push-Pull output. A turn of only one knob is necessary to switch from "Superhet" to "Straight." The Gramophone Amplifier has been specially studied and records can be reproduced with excellent quality 12 gns.

Illustrated Art Catalogue giving full specification and details of our 8 Models will be sent upon request.

All chassis on 7 days' approval, carriage paid. 12 MONTHS' GUARANTEE.

ARMSTRONG MANUFACTURING CO.
WALTERS ROAD, HOLLOWAY, LONDON, N.7.
(Adjoining Holloway Arcades.) 'Phon.: NORTH 3213.

RADIOMART THE SHORT-WAVE SPECIALISTS

SPECIAL OFFER!!!
Fully shrouded Transformer: by America's largest manufacturer. While they last.

All 230 v. primary and fully impregnated.	
T28708—375/375 v. 150 m/A. 6.3V3A. 2.5V5A. 5V3A	15/-
T19610—350/350 v. 150 m/A. 2.5V6A. 2.5V2A. 5V3A.	12/6
T7236—375/375 v. 120 m/A. 6.3VCT. 4A. 5V3A.	10/6
T7236—350/350 v. 100 m/A. 6.3VCT. 3A. 5V3A	8/6
T7307—350/350 v. 80 m/A. 6.3VCT. 3A. 5V3A	7/6
T7600—320/320 v. 50 m/A. 6.3V4A. 5V3A.	7/6
T6225—320/320 v. 80 m/A. 2.5V6A. 5V3A.	7/6
T44919—10V4A Primary Tapped 110—250 v.	5/6
T1113AB—110/230 v. 500 watt Auto Transformer	29/6
The following chokes are interleaved and impregnated.	
T7007—250 m/A. 135 ohms, 20-3 Hy., cadmium shrouded.	12/6
T7607A—150 m/A. 250 ohms, 30-12 Hy., cadmium shrouded.	12/6
100 m/A., 20 Hy., 300 ohms, unshrouded	4/11
50 m/A., 15 Hy., 250 ohms	1/11
HEAVY DUTY TRANSFORMER for models, bells, etc., 6 v. 3 a., 2/3	
4 m., 1,500 v. test 500 v. wkg. oil filled condensers, 2/-	
HEAVY DUTY Mains Transformer , worth 45/-, 350-350. 150 m/A.	
4 v. 2.5 a. CT. 4 v. 6 a. CT. 12/6; 350-300 v. 80 m/A., 4 v. 3 a. CT., 4 v. 2 a. CT. 6/6. Moving Coil Speaker Transformers, power, pentode or push pull, 1/11. WB Heavy duty ditto 2/11.	
GANG CONDENSERS with Airplane Dial, 8 and 80-1. Cost 35/-. Few only. 4/11. Utility, 7/6. Microdials, 3/9.	
W.B. 5in. PERMANENT MAGNET SPEAKERS AT ONE-THIRD COST Extension Type (no Transformer) 8/11. Standard Type (with Transformer) 10/6. Energised 8", 1200 ohms with Transformer, 6/11.	
PUSHBACK Wire , 6 yds. 6d., heavy 9d. Resin-cored Solder, 6ft. 6d.; Screened Flex, single, 6d. yd.; twin, 9d. yd. Assorted Solder Tags, 6d. packet. Humdimers 6d. each. Centralab pots, all sizes, 1/6; Components and is yours for 1s. post free. TRADE ENQUIRIES solicited for all types of communication equipment, transmitters, receivers, etc.	

OUR NEW 66-PAGE MANUAL, packed full of valuable information. Communication receivers, transmitters, etc., 7/4d. post free.

THE NEW RAYMART CATALOGUE shows dozens of New Short-wave Components and is yours for 1s. post free. **TRADE ENQUIRIES** solicited for all types of communication equipment, transmitters, receivers, etc.

RADIOMART Telephone: MIDland 3254
G5NI (Birmingham) Ltd.
44, HOLLOWAY HEAD, BIRMINGHAM

NEW RECEIVERS AND AMPLIFIERS

*
*
CHALLENGER Range for 1940.

CHALLENGER RADIO CORPORATION.—2d. stamp for illustrated catalogues of battery, battery-mains, car radio, and mains receivers; 63/- to £28; sale list also available.

CHALLENGER RADIO CORPORATION, 31, Craven Terrace, London, W.2. Nearest point, Lancaster Gate Station. [8872]

RADIO CLEARANCE, Ltd.

ALL Lines Previously Advertised Still Available.

ALL Orders Over 5/- Carriage Free; under this amount sufficient postage must be included with order.

ALL Enquiries Must Enclose 1½d. Stamp.

RADIO CLEARANCE, Ltd., 63, High Holborn, W.C.1. Holborn 4631. [8859]

ALERT RADIO CO.

A.R.P. Just Arrived, portable receiver which operates from its own dry batteries (which last for 200 hours) or from AC or DC mains, superhet incorporating 5 valves, medium and long wavebands; Midget receivers from £2/17/6; repairs to all types of receiver carried out at shortest notice, replacement valves and condensers; trade inquiries invited.—21, East Rd., N.1. Clerkenwell 4871. [8874]

AMAZING Offer.—Famous 7-valve push-button 1939 models in maker's sealed cartons, issued 13½ gns.; £5/19/6; list free.—Shippers, 18, Corporation St., Manchester. [0639]

ARMSTRONG Co.—After many years at our old premises at Camden Town we have removed to a new building in Walters Rd., Holloway, N.7 (see displayed advertisement).

ARMSTRONG Amplifier Division Has Removed to New Premises at 94, Camden Rd., N.W.1. In addition to our standard range of 6- and 12-valve push-pull high fidelity amplifiers and local station feeder units, we manufacture equipment for special purposes, pre-stage units, electronic mixers, tone control units, etc.

ARMSTRONG Are Always Pleased to Assist in the Solution of Special Problems; details of standard equipment free on request.

ARMSTRONG Co. (Amplifier Division), 94, Camden Rd., N.W.1. [8752]

CAR RADIO

1939 Models from 4½ gns., 6 new car aeriels, from 9/6; trade enquiries solicited; lists free.—Shippers, 18, Corporation St., Manchester. [0622]

PUBLIC ADDRESS

VORTEXION P.A. Equipment.

IMITATED, but unequalled.

WE Invite You to a Demonstration.

A.C.-D.C. Dance Band Amplifier, 10 watts output, complete in case, with moving coil microphone, speaker and cables, weight 22lb.; 12 gns.

A.C.-20 15-20-watt Amplifier, 38-18,000 cycles, independent mike and gram, inputs and controls, 0.037 volts required to full load, output for 4, 7.5, and 15 ohms speakers, or to specification, inaudible hum level, ready for use; 8½ gns. complete.

C.P. 20 12-volt Battery and A.C. Mains Model, as used by R.A.F., output as above; 12 gns.

A.C.-20, in portable case, with Collard motor, Piezo pick-up, etc., £14; C.P.20 ditto, £17/17.

50-WATT Output 61.6s. under 60-watt conditions, with negative feedback, separate rectifiers for anode screen and bias, with better than 4% regulation level response, 20-25,000 cycles, excellent driver, driver transformer, and output transformer matching 2-30 ohms impedance electronic mixing for mike and pick-up, with tone control, complete with valve and plugs; £15.

COMPLETE in Case, with turntable, B.T.H., Piezo pick-up and shielded microphone transformer; £20.

80-WATT Model, with negative feedback; £25, complete.

120-WATT Model, with negative feedback; £40, complete.

250-VOLT 250 m.a. Full Wave Speaker field supply unit; 25/-, with valve.

ALL P.A. Accessories in Stock; trade supplied.

VORTEXION, Ltd., 182, The Broadway, Wimbledon, S.W.19. 'Phone: Lib. 2814. [8241]

TANNOY 25-watt Amplifier, Ad-on-Unit, A.C. mains, complete; £10.—Easco, 18w, Brixton Rd., S.W.9. [0643]

AMPLIFYING Equipment, P.A. vans for sale or hire. Booklet on request.—Alexander Black, Ltd., 55, Ebury St., S.W.1. Sloane 6129. [0599]

PARTIDGE P.A. Manual, free to trade, from N. Partridge, B.Sc., A.M.I.E.E., King's Buildings, Dean Stanley St., London, S.W.1. [0631]

PUBLIC Address Contractors Can Hire P.A. Vans, loud speakers, microphones and equipments of all types from Hire Dept., Gramphon Reproducers, Ltd., Kew Gardens, Surrey. Tel.: Richmond 1175-6-7. [0618]

NEW MAINS EQUIPMENT

VORTEXION Mains Transformers, chokes, etc., are supplied to G.P.O., B.B.C., L.P.T.B. Why not you?

VORTEXION, Ltd., 182, The Broadway, Wimbledon, London, S.W.19. Telephone: Liberty 2814. [8878]

NEW LOUD-SPEAKERS

BAKERS New Corner Horn Speakers, triple cone versions; from 29/6, and surplus speaker bargains.—Bakers Selhurst Radio, 75, Sussex Rd., South Croydon. [8728]

TRANSMITTING APPARATUS

A.C.S. RADIO, specialists in short wave apparatus, communication receivers, including Hallicrafters, National and R.M.E. transmitting equipment, valves and components. Send for free catalogue to A.C.S. Radio, 16, Gray's Inn Rd., W.C.1. Holborn 9894-5. G2NK, Technical Manager. [0550]

G5N1—The oldest and largest distributor of amateur equipment transmitting and receiving; short-wave catalogue, 1½d. G5N1 70-page Manual, 7½d., post free; authorised direct distributor for Collins, National, R.M.E., Thordarson, Hammerlund, Biley, Taylor, Elmac, etc., etc.—44, Holloway Head, Birmingham. [0531]

CABINETS

A CABINET for Every Radio Purpose.

CONVERT Your Set into a Radiogram at Minimum Cost; surplus cabinets from noted makers under cost of manufacture (undrilled); 30/- upwards; motors at wholesale prices.

"FIT-A-GRAM" Cabinet, 31x17x15, 21/-.

UNDRIILLED Table Console and Loud-Speaker Cabinets from 3/6.

INSPECTION Invited; photos loaned to country cus- tomers.

H. L. SMITH and Co., Ltd., 289, Edgware Rd., W.2. Tel.: Pad. 5891. [0485]

DYNAMOS, MOTORS, ETC.

ALL Types of Rotary Converters, electric motors, bat- tery chargers, petrol-electric generator sets, etc., in stock, new and second-hand.

A.C.-D.C. Conversion Units for Operating D.C. Re- ceivers from A.C. Mains, 100 watts output, £2/10; 150 watts output, £3/10.

WARD, 46, Farringdon St., London, E.C.4. Tel.: Holborn 9703. [0518]

ELECTRADIX Rotary Converters for A.C. Radios on D.C. Mains; alternators, 50 to 500 cycles; mains motors and motor generators for 1 to 600 cells; petrol engines and switchgear.—218, Upper Thames St., London, E.C.4. [0619]

RECORDING EQUIPMENT

ALL Recording Discs and Materials in Stock, tracker units, £4/7/6; recording motors, £3/17/6.—Write for further details, Will Day, Ltd., 19, Lisle St., W.C.2. [0695]

VALVES

SPECIAL Line of Rogers and Majestic Tubes, types 551, 227, 551s, 55s, 6B7, 56 and 58, 2B7, 6 red 5 and 53; 3/6.

ALL Types of American Tubes in Stock of Impex and Arcurus makes at competitive prices.

WE Can Also Supply a Full Range of Guaranteed Re- placement Valves for Any British non-ring, Ameri- can or Continental type at an appreciably lower price.

SEND for Lists of These, and also electrolytic condensers, line cords, resistances, etc.

CHAS. F. WARD, 46, Farringdon St., London, E.C.4. Tel.: Holborn 9703. [0452]

AMERICAN, 2/9; 1,000 non-ring British from 1/9; bargains galore; lists free.—Shippers, 18, Corporation St., Manchester. [0607]

METROPOLITAN RADIO SERVICE.—Special offer. American valves, in maker's cartons, 3/- each, Octals, 3/6 each; American valves, first grade, in all types; trade supplied.—1021, Finchley Rd., N.W.11. Speedwell 3000. [0436]

COMPONENTS

SECOND-HAND, CLEARANCE, SURPLUS, ETC.

R **RADIO CLEARANCE, Ltd.**

ALL Lines Previously Advertised Still Available.

ALL Orders Over 5/- Carriage Free; under this amount sufficient postage must be included with order.

ALL Enquiries Must Enclose 1½d. Stamp.

RADIO CLEARANCE, Ltd., 63, High Holborn, W.C.1. Holborn 4631. [8858]

PREMIER SUPPLY STORES.

PLEASE See Our Displayed Advertisement on page 3. [0488]

VAUXHALL—All goods as previously advertised still available; write for free list.—Vauxhall Utilities, 163a, Strand, W.C.2. [8727]

SOUTHERN RADIO, 46, Lisle St., London, W.C. Ger- ard 6653.—Stocks of receivers and replacement components as previously advertised. [8548]



Said that veteran radio- man, Pace, "That crystal set in its glass case May make you amused, But since FLUXITE I used, It's the first of a very long race!"

See that **FLUXITE** is always by you—in the house —garage—workshop—wherever speedy soldering is needed. Used for 30 years in Government works and by leading engineers and manufacturers. Of Ironmongers—in tins, 4d., 8d., 1/4 and 2/8. Ask to see the **FLUXITE SMALL-SPACE SOLDERING SET**—compact but substantial—Complete with full instructions, 7/6. Write for Free Book on the art of "SOFT" SOLDERING—and ask for leaflet on **CASE-HARDENING STEEL** and **TEMPERING TOOLS** with **FLUXITE**.

TO CYCLISTS! Your wheels will NOT keep round and true unless the spokes are tied with fine wire at the cross- ings AND SOLDERED. This makes a much stronger wheel. It's simple—with **FLUXITE**—but **IMPORTANT!**

THE FLUXITE GUN

is always ready to put Fluxite on the soldering job instantly. A little pressure places the right quantity on the right spot and one charging lasts for ages. Price 1/6 or filled 2/6.

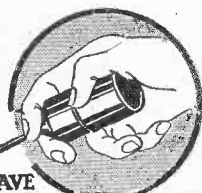

ALL MECHANICS WILL HAVE

FLUXITE

IT SIMPLIFIES ALL SOLDERING

FLUXITE LTD., Dept. W.W., DRAGON WORKS, BERMONDSEY ST., S.E.1

THE POLYTECHNIC
REGENT STREET, W.1

Evening Session, 1939-40

Courses and Classes, including laboratory work, in

Radio & Television Engineering

extending over a period of **FIVE YEARS** and suitable for those engaged in, or desirous of entering the Radio, Television, or Talking Film Industries.

A COURSE IN RADIO SERVICE WORK EXTENDING OVER TWO YEARS

Courses prepare for the National Certificate Graduateship Examination of the I.E.E., City and Guilds Certificates, and Examinations of the Institute of Wireless Technology.

SESSION COMMENCES SEPTEMBER 25th, 1939. Enrolments: September 18th to 22nd, from 6 to 9 p.m. Full particulars and prospectus from the Director of Education.

THE WIRELESS ENGINEER

The Journal of Radio Research and Progress

For professional wireless engineers, educational authorities, students, and all associated intimately with wireless.

Monthly 2s. 6d. net.

LIFFE & SONS LTD., LONDON, S.E.1

W.V.9

COMPONENTS—SECOND-HAND CLEARANCE, SURPLUS, ETC.

COULPHONE RADIO, Ormskirk.—1939 14gn. Crosleys, £6/2/6, carriage paid. 1½d. stamp catalogues. [8875]

RYALLS RADIO, 280, High Holborn, London, W.C.1. Business temporarily closed. [8876]

MAINS RADIO DEVELOPMENT COMPANY are carrying on under the management of Proprietor's wife.—Still giving same super delivery and goods; stamp for list 230. (100 new season's bargains.) Note new address.

MICA Tag Condensers; latest Dubilier midgets; 0.00005, 0.0001, 0.0002, 0.0003, 0.0005 mfd., 3d.; 2/6 dozen.

ERIE One-watt Colour-coded, unused resistors, any size, 50 ohms to 5 meg.; your selection, 3d., 2/6 dozen; 2-watt, 6d.

CENTRALAB Latest Potentiometers, long spindle, un- used, all sizes, 5,000 to 2 megohms, 2/- with switch, 2/3.

TUBULAR Condensers, 400 v.w., wire ends, non-induc- tive, test make, 0.0001 to 0.05 mfd., 4d.; 0.1 mfd., 4d.; 0.25, 0.5 mfd., 6d.

FIFTY Unused N.S.F. ½, 1- and 2-watt Resistors, wire ends, colour-coded; 20 different useful sizes in each parcel; 50 for 2/6.

MAINS RADIO DEVELOPMENT COMPANY, 52a, Church Crescent, London, N.10. Same super ser- vice as for last seven years but please Note New Address. [8865]

REPAIRS AND SERVICE

"SERVICE With a Smile."

AMERICAN Valves, spares, linecords, rewinds, repairs A. of all types of American and British receivers.—E.R.L., Ltd., 22, Howland St., W.1. Museum 5675. [0434]

GUARANTEED Repairs, Any Transformers, choke, motor armature, converter, dynamo, etc., keenest prices, immediate quotation, prompt, dependable service.—See below.

L.T.P. (LONDON TRANSFORMER PRODUCTS, Ltd.), Willesden, N.W.10. Willesden 6486 (3 lines). [8892]

MAINS Transformer Service, Repairs, rewinds, or construction to specification of any type, competi- tive prices and prompt service.—Sturdy Electric Co., Dip- ton, Newcastle-on-Tyne. [0516]

METROPOLITAN RADIO SERVICE.—Guaranteed repairs to American and British receivers; Ameri- can valves, service parts and rewinds; trade supplied.—1021, Finchley Rd., N.W.1. Speedwell 3000. [0435]

REPAIRS to Moving Coil Speakers a Speciality; cones and coils fitted, fields altered; prices, including eliminators, quoted; loud speakers, 4/-; L.F. and output transformers, 4/- post free, guaranteed satisfaction; trade invited, estimates free; prompt service.—Loud-Speaker Repair Works, 5, Balham Grove, London. Battersea 1321. [0594]

SITUATIONS VACANT

AIR MINISTRY.

AERONAUTICAL Inspection Directorate.

VACANCIES Exist for Unestablished Appointments as Examiners in the W.T. and Instrument Branches.

QUALIFICATIONS:

ALL Candidates must have had Good General Educa- tion, be able to read drawings, understand specifi- cations, use micrometers and other measuring instruments.

APPLICANTS for the Instrument Branch must have Knowledge of Physics and Training in Light Engi- neering or Instrument Making; candidates with knowledge of optical instruments are also required.

APPLICANTS for the W.T. Branch must have Prac- tical Knowledge of W.T. and Electrical Equipment, with technical training in radio communication equal to City and Guilds Final Examination standard.

APPLICATION from Candidates Previously Declared Unsuccessful will be Considered, provided the neces- sary additional experience has been gained.

ACCEPTED Candidates will undergo a Period of Train- ing in Inspection, as applied to the above subjects, not exceeding three months, and will be paid £3/10 weekly during training; subsistence allowance of £1/5 weekly during training is payable to married men who normally reside outside the training area; on successful completion of training they will be appointed as Exam- iners, paid £246 a year, rising by increments of £12 to £337 (if service is satisfactory), and must be prepared to serve in any part of the United Kingdom and to fly as observers in connection with their duties.

NORMAL Age Limits, 21 to 50.

FURTHER Particulars on Application, by post card only, to:

THE Under-Secretary of State, Air Ministry (ICS/ REC/45), Berkeley Square House, Berkeley Square, London, W.1. [8870]

WAR DEPARTMENT.

CIVILIAN Instructor in Electrical Engineering Re- quired for the Military College of Science, Woolwich.

CANDIDATES Should Preferably be Under 45 Years of Age, and must be capable lecturers; a sound knowledge of the principles of electricity—especially as applied to measuring instruments and communication ap- paratus, as well as knowledge and experience of modern radio apparatus, essential.

PAY (weekly) £5/5, rising by annual increments of 2/6 to £5/17/6.

POST is Unpensionable; successful candidate will be required to take up duties as soon as possible.

PREFERENCE Given to Ex-members of H.M. Forces, other things being equal.

APPLICATION Forms, obtainable by post card from Commandant, Military College of Science, Red Barracks, Woolwich, S.E.18, to be lodged not later than 16th September, 1939. [8869]

THE POLYTECHNIC
REGENT STREET, W.1

Evening Session, 1939-40

Three Advanced Courses, each of about 24 Lectures, on

DESIGN OF RADIO APPARATUS

WAVE PROPAGATION AND RECEPTION

AND

RADIO-FREQUENCY MEASUREMENTS

will be given by

H. A. THOMAS, D.Sc., M.I.E.E.,
and
C. W. SPENCER, B.Sc.

SESSION COMMENCES SEPTEMBER 25th, 1939.

Enrolments: September 18th to 22nd, from 6 to 9 p.m.

Syllabuses and further particulars may be obtained from the Director of Education.

Pamphonic
AMPLIFIERS

Pamphonic Reproducers Ltd. (Associated with PYE Ltd.)
45, St. Pancras Way, London, N.W.1.
Phone: EUSTON 1727.

NORTHAMPTON POLYTECHNIC
ST. JOHN STREET, LONDON, E.C.1.

Full-time and part-time Courses are conducted in all branches of

ENGINEERING

EVENING CLASSES include:
HIGH POWER (SHORT CIRCUIT) THEORY AND OSCILLOGRAPHY,
HIGH VOLTAGE THEORY AND TESTING,
GENERAL ELECTRICAL ENGINEERING,
RADIO COMMUNICATION, TELEVISION,
AND ULTRA HIGH FREQUENCY.

Entrance Examination for Day Courses: 20th and 21st September, 1939.
Enrolment Week, Evening Classes: 18th-22nd September, 1939.
Prospectuses, etc., on application.

Mains Transformers as specified for *The Wireless World* High Quality Communication Receiver Type WW51-45/-.

W. BRYAN SAVAGE LTD.
Westmoreland Rd., London, N.W.9. Phone: Colindale 7131

THE INSTITUTE OF WIRELESS TECHNOLOGY
(Founded in 1925. Incorporated.)

EXAMINATION ENTRIES
Candidates for the November Examinations must apply not later than September 30th.

Application Forms and Syllabus may be obtained from the Secretary:—Harrie J. King, F.C.C.S., Institute of Wireless Technology, 4, Vernon Place, Southampton Row, London, W.C.1.
Phone: Holborn 4879.

The

ELEMENTARY PRINCIPLES

of

WIRELESS TELEGRAPHY

and

TELEPHONY

by

R. D. BANGAY

Third Edition
Revised by O. F. Brown, B.Sc. (1930)

7/6 net By post 8/-

From all leading Booksellers or direct from the Publishers

ILIFFE & SONS LTD.
Dorset House, Stamford Street, London, S.E.1
W.W.97

SITUATIONS VACANT

WIRELESS.—Technical instructors required at Army stations in Great Britain.

WAGES (Adults).—85/-, rising by 2/6 annually to 95/- a week (payable from date of entering course of instruction).

CANDIDATES Should Preferably be Under 35, and (a) hold one of the following qualifications:—Graduate of the Institution of Electrical Engineers; Final (Grade III) Certificate of City and Guilds of London Institute Examination in Radio Communication; Higher National Certificate in Electrical Engineering; Certificate of City and Guilds of London Institute in Radio Service work; or similar qualification;

OR (b) be Able to Pass an Examination on the Following Syllabus:—

CURRENT Electricity.—Properties of an electric current; Ohm's Law and its applications; galvanometers and measuring instruments; electro-magnetism; magnetic materials.

ALTERNATING Currents.—General principles; effects of resistance, inductance and capacity; resonance.

RADIO.—General character of a radio signal; elementary knowledge of valves and their simple applications.

SUITABLE Candidates—other than holders of the qualifications stated at (a) above, who may be accepted for training without interview—will be interviewed and undergo a short, written examination; those selected will enter a course of instruction at the Military College of Science, Woolwich; on final acceptance, to depend upon an examination after three weeks' instruction, successful candidates will be required to give an undertaking to enlist into the Territorial Army (with rank of sergeant) and will receive a further three weeks' instruction before transfer to their permanent stations; regular travelling expenses on transfer will be payable.

APPOINTMENTS are Not Pensionable; preference given to ex-members of His Majesty's Forces, other things being equal.

APPLICATION Forms, obtainable by post card from the Under-Secretary of State (C.5), War Office, S.W.1, to be lodged by 16th September, 1939. Quote Appts. No. 160. [8868]

DRAUGHTSMEN Required (in the Midlands); used to small part mechanisms; write, giving particulars of experience, also state age and salary required.—Box 921, c/o *The Wireless World*. [8843]

TRANSFORMER and Rectifying Equipment Manufacturers Require Two Technical Assistants, aged 16-24.—Apply by letter only, stating salary required, to General Manager, F. C. Heayberd and Co., Ltd., 10, Finsbury St., E.C.2. [8867]

RADIO Testers Required; applicants must have had technical training and experience of receiver circuit trimming on factory production lines.—Apply Employment Dept., Murphy Radio, Ltd., Welwyn Garden City, Herts, or nearest Employment Exchange. [8871]

RADIO Engineers Required in Development Section of Large Organisation Producing Radio Communication Equipment; applicants should have experience with high frequency or ultra high frequency engineering; small or medium power transmitters or associated equipment; capable of preparing electrical and mechanical design.—Write, stating qualifications, experience and salary expected to Box 949, c/o *The Wireless World*. [8866]

ELECTRIC DRY SHAVERS

REMINGTON, Rand, Shavemaster, Packard, Casco, Rabaldo.—Trade enquiries to Leonard Heys, 36, Henry St., Blackpool. [0633]

MISCELLANEOUS

EVERY Radio Dealer Who is Not a Regular Reader of "The Wireless and Electrical Trader" should send his trade card at once for a specimen copy and full details of the "Trader" Services. "The Wireless and Electrical Trader" has the widest influence, the largest weekly circulation, and is read by all the leading manufacturers and traders. Trade only. 15/- per annum, post free.—Published at Dorset House, Stamford St., London, S.E.1. [0615]

"**ENGINEER'S** Guide to Success" Shows How to Qualify in Television Radio Engineering and Servicing, sound, recording, wireless communicating, etc., by studying at home with the T.I.G.E. Write to-day for this Great Guide—free—which gives full particulars, contains the world's widest choice of engineering courses—over 200—and also gives the regulations for qualifications such as A.M.I.E.E., A.M.I.R.E., A.M.I.P.E., A.M.I.W.T., C. and G., etc. Training until successful guaranteed.—The Technological Institute of Great Britain, 82, Temple Bar House, London, E.C.4. (Founded 1917. 20,000 successes.) [8782]

PATENTS

PATENTS and Designs Acts 1907 to 1939.

NOTICE is hereby given that Marconi's Wireless Telegraph Co., Ltd., of Marconi Offices, Electra House, Victoria Embankment, London, W.C.2, Noel Meyer Rust, of "The Glen," Danbury Common, Chelmsford, Essex, and John Forrest Ramsay, of 55, New St., Chelmsford, Essex, seek leave to correct the complete specification and drawings of Letters Patent No. 49360, granted to them for an invention entitled "Improvements in or Relating to Aerial Feed and Aerial Tuning Circuit Arrangements."

PARTICULARS of the Proposed Corrections were set forth in No. 2641 of the Official Journal (Patents) published on 30th August, 1939.

ANY person, or persons, may give Notice of Opposition to the corrections by leaving Patents Form No. 35A at the Patent Office, 25, Southampton Buildings, London, W.C.2, within one calendar month from the date of publication of the said Journal.—M. F. Lindley, Comptroller-General. [8877]

PRACTICAL Hints on Patents, free on application.—The Imperial Patent Service, First Avenue House, High Holborn, W.C.1. Preliminary consultation free. [0481]

ELECTRADIX HELPS

A.R.P. PETROL ELECTRIC GENERATING SETS for Lighting and Charging. 20 STUART TURNER DIRECT COUPLED SETS, 150 watts D.C., 1,800 r.p.m. 2-stroke water-cooled 1 h.p. Engine with fuel and oil tank, magneto ignition. On bed plate with 30 volts 5 amps. Dynamo. £12.

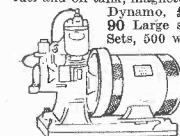

90 Large size 1/2 kW. STUART TURNER Petrol Electric Sets, 500 watts, 3-stroke water-cooled 1 h.p. 1-cyl. Engine on bed plate direct coupled to 50/70 volts 10 amps. D.C. Dynamo magneto ignition, fuel and oil tank, £16, worth double.

ASTER Single Cyl. W.C. Engine, Bosch Mag., 24 kW. Set 220 volts. Claude H. Carr. Coupled 12 amps. compound Dynamo, £20.

Horizontal Twin Petrol A.B.C. Engine, fan-cooled, coupled 1 1/2 kW. D.C. Dynamo 50/70 volts 25 amps, Mag. ignition. Cost £190. Sale £25.

24 kW. AUSTIN 2-cyl. water-cooled Engine, Mag. ignition and 110 volts 25 amps. Dynamo, £29. Austin 3 1/2 kW., 110 volts, £48. Switchboards, £5. Ask for Special Leaflets.

A.R.P. EDISON HIGH-CAPACITY STEEL CELLS at half price for standby lighting, 120 A.H. to 300 A.H. at 20/- to 25/-. Makers' Price is £5. Ask for leaflet.

TAPE MORSE RECORDERS. For 30 w.p.m. radio or land line. New portable walnut case, very complete model with key and meter indicator. Standard G.P.O. type with tape reel on base. For experimenters we have a few incomplete with perfect spring drive. Paper tape reels, 6d. **RAID BELLS, ALARM BELLS.** Mains, battery or magneto waterproof types, Priority for A.R.P. Portable H.T. for emergency outdoor field transmitters. Hand Generators in tank cases by Evereds, 80 and 1,600 volts D.C. Portable Emergency Telephone stations in case, 60/-; Light-weight twin field cable unbreakable Army type, 55/- mile. Emergency day and night Lucas and Aldis Army Signal Lamps, telescopic sights, hand or tripod. For Fire Brigades and Police, 60/-.

POCKET HEADPHONES. W.D., all leather headband, strap and cords, 2/6 pair. Wireless type, with aluminium headbands, 2/9; 4,000 ohms, 4/6.

YOU MUST KEEP YOUR BATTERY PREPARED!!! Battery Charging on A.C. Mains. The A.C. NITNDAY will keep your battery fit without attention. Model N/A6, 100/250 volts A.C. and D.C. 6/8 volts 1 amp., 15/-; Model N/B6, 100/250 volts to D.C. 6/8 volts 1 amp., 25/-; Model N/C6, 100/250 volts to D.C. 6/8 volts 2 amps., 35/-; Model N/D12, 100/250 volts to 12 volts 1 amp., 32/-; Ditto, 12 volts 2 amps., with 6-volt tap, 55/-; 5 amp., £4/10/-.

DUG-OUT CRYSTAL SETS. Model B, Pol. Mahog. case, 9in. x 10in., 2 tuning condensers, plug-in coils, Permanent Detector, 7/6.

EMERGENCY PARCELS. Electrical and Radio 10 lbs. 5/- post free. **MIDGET 40 CRYSTAL SET,** complete with Perm. Detector, 6/9. M.11 Army Double Crystal All-wave Receiver, very rare. Cost £20, 56/-, M.11 Station Finder W.D. Crystal Sets, double Detector, wave-range calibrated in enclosed mahog. case, 24/6.

CRYSTAL RECEIVING. Super Detector, glass cover, fine adjustment, 10/-; Enclosed 2-crystal permanent detector, 2/-; Carborundum Marconi Army Detector, 2/6; Galena point Detector, mounted, 1/8; Galena and Neutron Crystals, 5d., 6d., and Perikon, 2/-; Carborundum mounted, 8d.

SHELTER A.R.P. Ventilation and Air Conditioning A.C. or D.C. Mains, 80 watts; 9in. Blower, 20 cub. ft. fresh air per min., 25/-.

RELAYS. Over 2,000 in stock of various types for all purposes.

ELECTRIC PUMPS, for A.C. or D.C., 12 v. to 230 v. Centrifugal all-bronze pump, throws 120 gals. per hour. 6ft. Carvans, Bungalows and Boats, 67/6. Larger pumps for cesspools, dug-outs, etc., £5/10/-.

BUZZERS. BUZZERS. BUZZERS for all purposes. The well-known robust Model D. For Morse Practice or Signals. Now supplied for 1/- only. Morse Practice Sets, No. 3, with key buzzer and lamp for sound and visual, line plug, etc., 7/-; Sound Type, 1A type key and buzzer, 3/-; Visual Type 2A, key and lamp, 2/-.

KEYS. Govt. surplus Morse Keys. Type KBSL. Massive brass pivot bar, tungsten spring-mounted contacts and base lamp for light, 7/6. Walters service battery enclosed Key, for high voltage, 10 amp. contacts, good bridge key, 10/6. Super Keys, Brown's Car Patrol, double acting, beautifully made and balanced, totally enclosed, case, All cover, for H.T., 21/-; Massive Navy type Ship Keys, 25/-.



Don't forget to send now for our Bargain List "W."

ELECTRADIX RADIOS
218 Upper Thames Street, London, E.C.4
Telephone: Central 4611

ENGINEERS!
ARE YOU EARNING LESS THAN £10 PER WEEK?

If so, you cannot afford to carry on without reading our 268-page Handbook. The book explains clearly and definitely many ways of carving out a successful career. Among other things it explains the Services of our unique Appointments Department; outlines Home-Study Courses in all branches of Civil, Mechanical, Electrical, Motor, Aero, Wireless, "Talkie" Engineering, Building, Govt. Employment, etc., and gives details of B.Sc., A.M.I.C.E., A.M.I.E.E., A.M.I.Mech.E., A.M.I.A.E., A.M.I.W.T., A.M.I.R.E., G.P.O., MATRIC, and all Exams. We Guarantee — "NO PASS—NO FEE." Whether you be an old hand or a budding apprentice get this book to-day. FREE and POST FREE.

BRITISH INSTITUTE OF ENGINEERING TECHNOLOGY.
367, Shakespeare House, 17/19, Stratford Place, London, W.1.

NOW READY

PREMIER 1940 CATALOGUE

111 PAGES - - - - - PRICE 6d.

Over 20 Pages of British and U.S.A. Valve Data, Receivers, Transmitters, Amplifiers, Components.

GET YOUR COPY TO-DAY!

ALL POST ORDERS TO: Jubilee Works, 167, Lower Clapton Road, London, E.5. Amherst 4723

CALLERS TO: Jubilee Works, or our NEW PREMISES, 169, FLEET STREET, E.C.4. Central 2833

or 50, High Street, Clapham, S.W.4. Macaulay 2381

FOURTH EDITION—
Revised and Enlarged with 50
Additional Pages

WIRELESS SERVICING MANUAL

By W. T. COCKING
(of "The Wireless World")

The most complete book of reference
of its kind. A reliable practical guide
for amateur and professional.

The present Edition of the
"Wireless Servicing Manual"
brings the material of the book
right up to date and includes an
additional chapter on television
receivers which is practically the
only source of servicing informa-
tion available on this subject.

Testing apparatus is fully dealt
with and the methods of locating
and curing faults in receiving
equipment are explained in detail.

Ganging, Automatic Volume
Control, Instability, Distortion,
Mains Hum, Whistles, Local
Interference and Aerials are all
separately treated.

The reference material, including
base - connections for British,
Continental and American valves
and the various colour codes for
components, has been extended
and revised.

BOUND IN CLOTH BOARDS
SIZE 7½ ins. × 5 ins.
288 Pages

PRICE 5/- net
By post 5/5

Issued in conjunction with
"THE WIRELESS WORLD" and
Published by the Proprietors :-

ILIFFE & SONS LTD.,
Dorset House, Stamford Street,
London, S.E.1

WW.20.

PATENTS

THE Proprietors of British Patent No. 230,642, relating to "Improvements in Radio Telephone Signalling," is desirous of entering into negotiations with one or more firms in Great Britain for the purpose of exploiting the invention either by sale of the Patent Rights or by the grant of licences on reasonable terms.—Interested parties who desire further particulars should apply to Albert L. Mond and Thiemann, of 14 to 18, Holborn, London, E.C.1. [8663]

THE Owners of Patents Nos. 460994 and 461073 for Moving Coil Loudspeaker Embodying Improvements in the Assembly Thereof in Combination With a Baffle-like System, wish to meet all demands for the patented apparatus and invite enquiries from manufacturers and others in Great Britain prepared to assist in the commercial exploitation of this invention.—Address, in first instance, Messrs. Dicker, Pollak, Mercer, Tench and Meyer, Chartered Patent Agents, 20-23, Holborn, London, E.C.1. [8864]

TUITION

RADIO Training.—P.M.G. exams. and I.E.E. Diploma; prospectus free.—Technical College, Hull. [0611]

PRACTICAL Postal Courses, radio television; test equipment design; I.P.R.E. and I.W.T. exams.—Write I.P.E., 3, Shirley Rd., London, W.4. [8838]

WIRELESS.—Complete training Marine, broadcast and television; posts waiting; mod. fees; boarders taken; approved college, prosp.—Dept. W., London Radio College, Grove Park Rd., London, W.4. (Chi. 3244.) [0580]

BUSINESSES AND PROPERTY FOR SALE, TO BE LET, OR WANTED

"THE Wireless and Electrical Trader" is an essential part of the equipment of every Wireless Trader; its pages reflect the very latest turn of trade events, and it is read by all the leading dealers and manufacturers, for particulars of businesses offered or wanted. By subscription to the trade only, 15/- per annum, post free.—Send your trade card for specimen copy to Dorset House, Stamford St., London, S.E.1. [0614]

BOOKS, INSTRUCTION, ETC.

AMERICAN Valve Data.—The 200-page Raytheon Data Book gives full characteristics, applications, all types American valves; invaluable to servicemen; post free anywhere; 2/3.—Leonard Heys, 36, Henry St., Blackpool. [0594]

ALL Wireless and Radio Engineering Books Available through new financial terms as low as 2/6 monthly.—Write a card or call personally for details and lists from the Radio Department, Phoenix Showrooms, 66, Chandos Place, Strand. [8623]

ELEMENTARY Principles of Wireless Telegraphy and Telephony." By R. D. Banguay. Revised by O. F. Brown, B.Sc. Third edition (1930). The standard textbook for wireless students and beginners. Deals with the whole subject of wireless telegraphy and telephony, avoiding too technical a treatment of the problems involved. Well illustrated. Price 7/6 net. By post 8/-, from Iliffe and Sons Ltd., Dorset House, Stamford St., London, S.E.1.

"THE Wireless World" Diary for 1939 contains 77 pages of facts, formulae and general information of the kind that is always wanted but is difficult to follow. Also a list of the most important European Broadcasting Stations and short-wave stations of the world. Twelve pages of circuit diagrams of receivers, amplifiers and units.—By post 1/7 from Iliffe and Sons Ltd., Dorset House Stamford Street, London, S.E.1.

FOUNDATIONS OF Wireless." By A. L. M. Sowerby, M.Sc. Second edition. An elementary textbook on receivers. Deals fully with the construction of wireless sets, valves, and the process of detection. Price 4/6 net. By post 4/11, from Iliffe and Sons Ltd., Dorset House, Stamford Street, London, S.E.1.

INDEX TO ADVERTISEMENTS

Armstrong Manufacturing Co.	1
Automatic Coil Winder Co., Ltd. ...	Inside Front Cover
Birmingham Radiomart G5N1	1
British Institute of Engineering Technology	3
British Insulated Cables, Ltd.	Inside Back Cover
British Roha, Ltd.	
British Thomson-Houston Co., Ltd., The	
Electradix Radios	3
Erie Resistor, Ltd.	
Fluxite, Ltd.	2
General Electric Co., Ltd.	Back Cover
Goodmans Industries, Ltd.	
Hartley Turner Radio	
Healey & Baker	
Institute of Wireless Technology	3
Masters, C. E.	
Northampton Polytechnic	3
Pamphonic Reproducers, Ltd.	3
Partridge, N.	
Players Cigarettes	Inside Back Cover
Polytechnic School	2, 3
Premier Radio	3
Salford Electrical Instruments, Ltd.	
Savage, W. Bryan, Ltd.	3
Sound Sales, Ltd.	Inside Front Cover

Second Edition—
Completely Revised

RADIO DATA CHARTS

A
SERIES OF ABACS
providing most of the essential
Data required in Receiver Design

By
R. T. BEATTY, M.A., B.E., D.Sc.

Published from the Offices of
"THE WIRELESS WORLD"

RADIO DATA CHARTS provide designers of wireless apparatus with a ready, convenient means of solving all the more familiar problems connected with the design of modern radio apparatus without having recourse to complicated formulae and mathematics.

In order to keep abreast of the great advances in wireless communication since the first edition of "Radio Data Charts" appeared, obsolete abacs have been omitted from this second edition and important fresh material added.

By the use of "Radio Data Charts," such abstruse problems as the design of tuning coils are solved almost as easily as the simple applications of Ohm's Law.

(37 CHARTS and 46 Diagrams)

Price 4/6 net
By Post 4/10

From all leading Booksellers or direct
from the Publishers

ILIFFE & SONS LTD.
Dorset House,
Stamford St., London, S.E.1

W.W.93



B.I. CONDENSERS

for
RADIO & GENERAL USE

B.I. CONDENSERS for Radio Receivers, Battery Eliminators, Smoothing Circuits, etc., are made in several different types to suit the various uses for which Condensers are required in connection with Wireless circuits.



These Condensers are the result of **36 years' experience** in the manufacture of all kinds of Condensers from the smallest sizes up to those weighing more than 2 tons.

In addition to the Standard Types, B.I. Condensers can be supplied in special forms to suit manufacturers' requirements.

The illustration shows Type 212 recommended for use with eliminators.

BRITISH INSULATED CABLES LTD.

Cable Makers and Electrical Engineers

PRESCOT, LANCS.

Telephone No.: **PRESCOT 6571.**

London Office: **SURREY HOUSE, EMBANKMENT, W.C.2**

Telephone No.: **Temple Bar 7722**

RADIO INTERFERENCE SUPPRESSION

By

GORDON WM. INGRAM, B.Sc.

NOW READY
Obtainable direct or through any Bookseller.

An invaluable book for every electrical and radio engineer, which will also be appreciated by servicing experts and wireless enthusiasts.

It classifies types and causes of interference and their remedy. The text and three appendices provide immediate and practical analysis of causes whilst the subdivision of electrical apparatus into groups makes for easy reference.

The contents include :—Coloured supplement : Interference Diagnosis. Sections on :—The nature of electrical interference and its classification. The production of interference by electrical plant. Technical considerations and the design of suppression apparatus. The industrial application of suppression. Tables and Reference List. Appendices :—Interference Classification Table—Suppression Method Table—Anti-Interference Aerials.

162
PAGES

60
ILLUSTRATIONS

PRICE

5/-
NET

By post 5/3

BOUND IN
CLOTH BOARDS

SIZE
7½" x 5"

Published by

ELECTRICAL REVIEW LTD.
DORSET HOUSE
STAMFORD STREET
LONDON S.E.1

In case of Emergency!

**MAKE SURE YOU
HAVE ADEQUATE
STOCKS OF**

**Osram
Valves**

MADE IN ENGLAND

*For full information and technical data of any
OSRAM VALVES write to the Osram Technical Dept. of*

**THE GENERAL ELECTRIC CO., LTD., MAGNET HOUSE, KINGSWAY,
LONDON, W.C.2.**

6^D

The Wireless World

THE PRACTICAL RADIO & TELEVISION JOURNAL

Thursday, September 14th, 1939

SCANNING COIL CONSTRUCTION

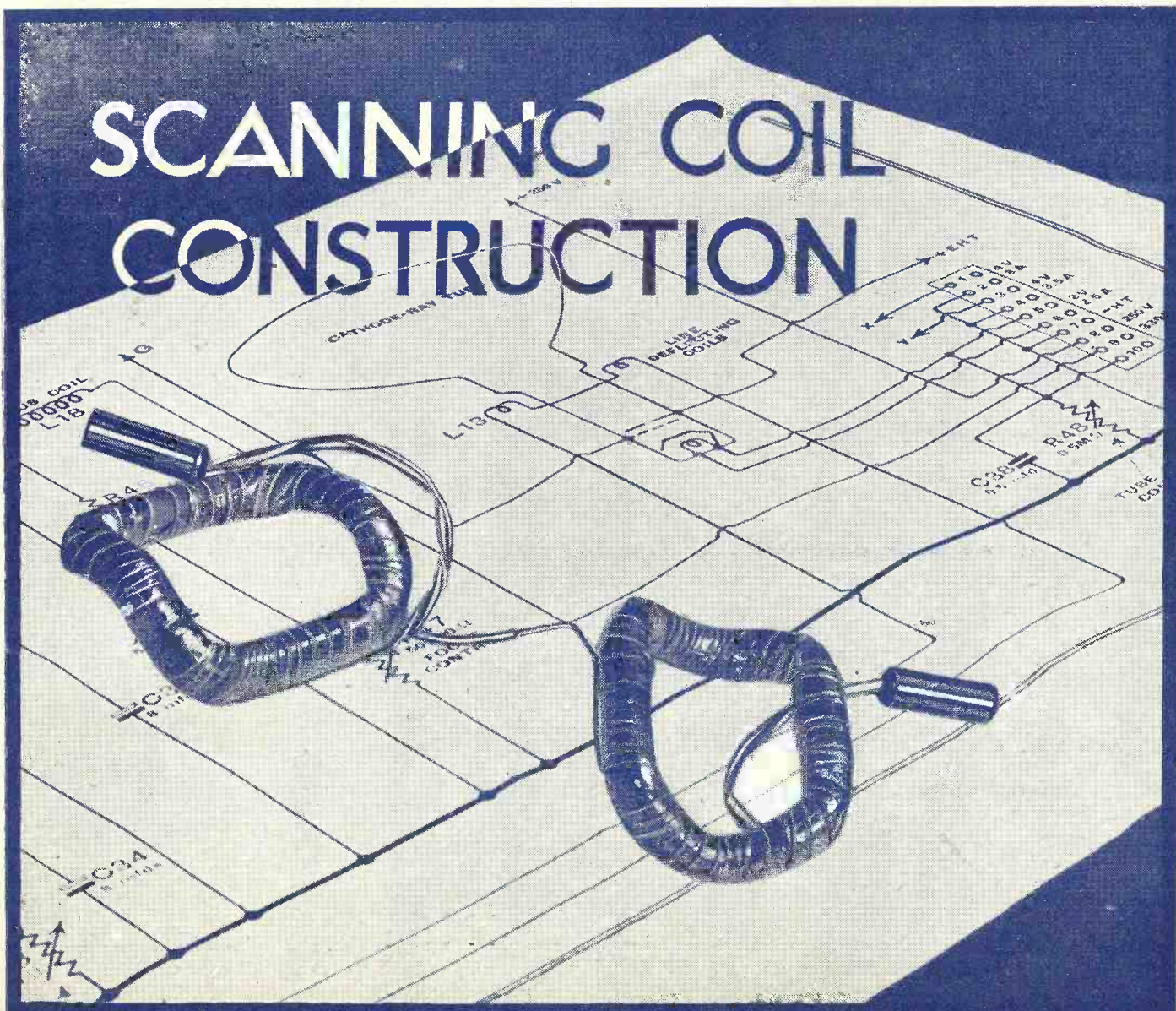

THERMIONIC MEASURING APPARATUS FOR MANY PURPOSES

THERMIONIC TEST SET

A UNIQUE INSTRUMENT OF REMARKABLE CAPABILITIES

Measures	
A.C.	D.C.
CURRENT : ·005 microamps to 5 amperes.	CURRENT : ·0005 microamps to 1 ampere.
VOLTAGE : 50 millivolts to 500 volts on frequencies from 25 to 20,000,000 cycles.	VOLTAGE : 1 millivolt to 500 volts.

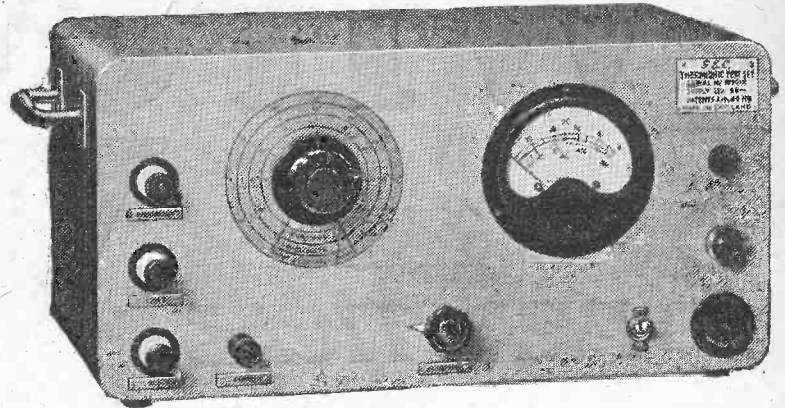

(Patent Applied for.)

PRICES: A.C. Model **£46-15-0**
Battery Model **£42-18-0**

This is an entirely new direct reading instrument operating on the Valve Voltmeter system for the measurement of A.C. or D.C. voltage and current.

A patented circuit of the D.C. amplifier type using negative feedback is employed with a potentiometer input. The instrument can be supplied for either battery or mains operation, and may be used on D.C. or A.C. up to 20 megacycles per second. The impedance of the instrument on D.C. and on audio frequencies when used as a Voltmeter on any range, is 10 megohms so that it can be used for measuring voltages in high resistance circuits with great accuracy, current consumption from the circuit being negligible.

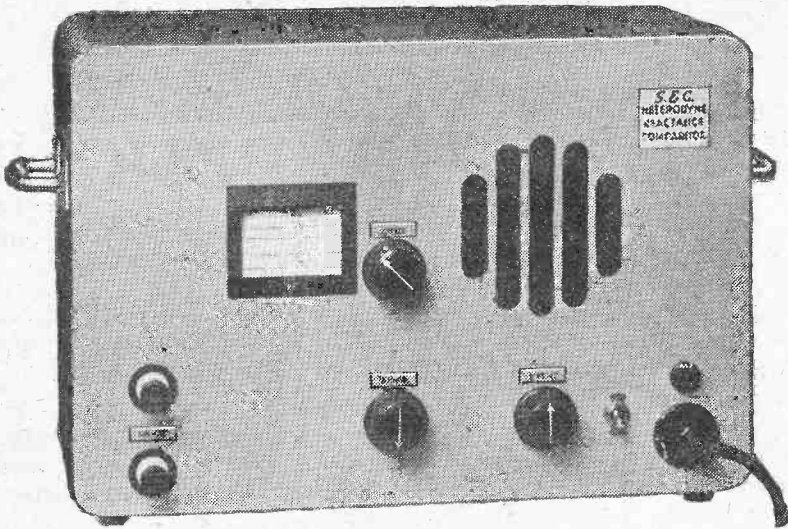

PRICE: **£42-18-0**

Two radio frequency oscillators, one variable, are employed and are made to beat against each other, and the resultant signal is rectified and heard on a loud speaker contained within the instrument. The variable oscillator is controlled by a knob and drum drive, the calibration of which indicates directly the percentage difference between the standard and the coil or condenser under test.

HETERODYNE REACTANCE COMPARATOR

FOR TESTING COILS AND CONDENSERS

A portable mains operated test set for the rapid checking of coils or condensers against standards *under mass production conditions.*

HIGH FREQUENCY TERMINALS

Registered Design No. 819,944.

This new H.F. Terminal has been introduced to meet the need for a terminal of truly scientific low loss design, and as the result of considerable research into the problem of losses and insulation resistances at radio frequencies a terminal has been produced which it is believed is without equal for its purpose at the present day.

The special ceramic insulation employed is not only of a very low loss type, but the proportion of it in the electrostatic field is small, whilst its shape with respect to the terminal stem and mounting bush is such as to provide the minimum loss conditions.

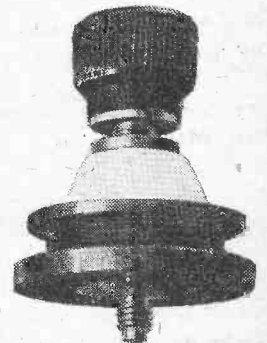

Actual size

Write for full particulars to:—

SALFORD ELECTRICAL INSTRUMENTS LTD.

PEEL WORKS, SALFORD, 3.

PROPRIETORS: THE GENERAL ELECTRIC Co. Ltd., OF ENGLAND

Telephones : BLAckfriars 8888 (3 lines)

Telegrams and Cables : 'SPARKLESS, MANCHESTER'

The Wireless World

THE
PRACTICAL RADIO
JOURNAL
29th Year of Publication

No. 1046

THURSDAY, SEPTEMBER 14TH, 1939

VOL. XLV No. 11

Proprietors : ILIFFE & SONS LTD.

Editor :
HUGH S. POCOCK.

Editorial,
Advertising and Publishing Offices :
DORSET HOUSE, STAMFORD STREET,
LONDON, S.E.1.

Telephone : Waterloo 3333 (50 lines).
Telegrams : "Ethaworld, Sedist, London."

COVENTRY : 8-10, Corporation Street.
Telegrams : Telephone :
"Autocar, Coventry." 5210 Coventry.

BIRMINGHAM :
Guildhall Buildings, Navigation Street, 2.
Telegrams : Telephone :
"Autopress, Birmingham." 2971 Midland (5 lines).

MANCHESTER : 260, Deansgate, 3.
Telegrams : Telephone :
"Iliffe, Manchester." Blackfriars 4412 (4 lines).

GLASGOW : 26B, Renfield Street, C.2.
Telegrams : "Iliffe, Glasgow." Telephone : Central 4857.

PUBLISHED WEEKLY. ENTERED AS SECOND
CLASS MATTER AT NEW YORK, N.Y.

Subscription Rates :

Home and Canada, £1 10s. 4d. ; other
countries, £1 12s. 6d. per annum.

*As many of the circuits and apparatus described in these
pages are covered by patents, readers are advised, before
making use of them, to satisfy themselves that they would
not be infringing patents.*

CONTENTS

	Page
Editorial Comment	247
Scanning Coil Construction. By P. D. Tyers	248
"The Multipactor": A Versatile Electron Multiplier	250
Low-power Transmission. By W. Oliver	251
Wireless in the Tropics. By "Colonial"	254
Television Progress: Report of the Olympia Convention	255
Above Three Megacycles	256
News of the Week	257
Interference from Electric Razors. By J. E. M. Coombes B.Sc. (Eng.)	259
Problem Corner	261
McMurdo Silver "15-17" (Series 11.): Test Report	262
Random Radiations	264
Recent Inventions.. ..	265

EDITORIAL COMMENT

Broadcasting in Wartime

A General Survey

ANY further proof that may be needed of the fact that broadcasting has now become essential to our national life has been provided during the last week or two. Many who have hitherto regarded it as one of the first things that could be dispensed with would now consider it a real hardship to be deprived of access to a receiver.

Perhaps this accounts for the totally unexpected demand, approaching a minor boom, that has arisen since the outbreak of war for certain classes of sets—and by no means the least expensive ones. Although the receivers are probably being bought mainly for news-gathering, the closing down of other forms of entertainment has probably caused their purchasers to turn to broadcasting for relaxation.

Nothing can interrupt the national sport of B.B.C.-baiting, and so it is not surprising that the usual Press correspondence on the badness of news bulletins was in full swing within a few days of the outbreak of war. As the Corporation was at the time fully engaged in putting into effect plans made to ensure the continuance of its service in any eventuality, this criticism may be considered as premature; the wonder is that the main service was so effectively maintained through a period of intense strain.

New Technique Wanted

Although it is considered that this criticism was premature, we believe that the whole technique of news presentation must be revised to suit war-time conditions. It is hardly the function of this journal to discuss details, but, without suggesting that

the methods of American broadcasting are suitable to the British mentality, we maintain that many useful lessons could be learned from the way that news has been handled by the great American network during the past few weeks. Many of our correspondents have expressed admiration of the service, and it is perhaps significant that contributors who usually confine themselves to the technicalities of wireless have been diverted into the technique of news presentation.

Time-saving Artifices

Transatlantic tempo may be too breathless for us, but there are several time-saving tricks that might be adopted here. Instead of the cumbersome "As was announced in earlier news bulletins" of the B.B.C., the brief "You know that . . ." of the American networks serves equally well as a warning that the item of news that is coming is not fresh. We might also adopt the idea of the "news analyst" who interprets the significance of the latest official communiques for the benefit of those who listen to American broadcasts.

Complaints have been voiced in Parliament that there is too much delay in giving us news of important happenings. That again is a matter with which this journal is not directly concerned, but we submit that the authorities should keep a close watch on foreign broadcasting with a view to considering whether there is any point in withholding from our own people an item of news that has already been transmitted from abroad, and so presumably has become known to our enemies. A still more important reason for keeping foreign stations under constant observation is that it may often become necessary to correct inaccurate reports without delay.

Scanning Coil Construction

By PAUL D. TYERS

MAKING THE DEFLECTING SYSTEM

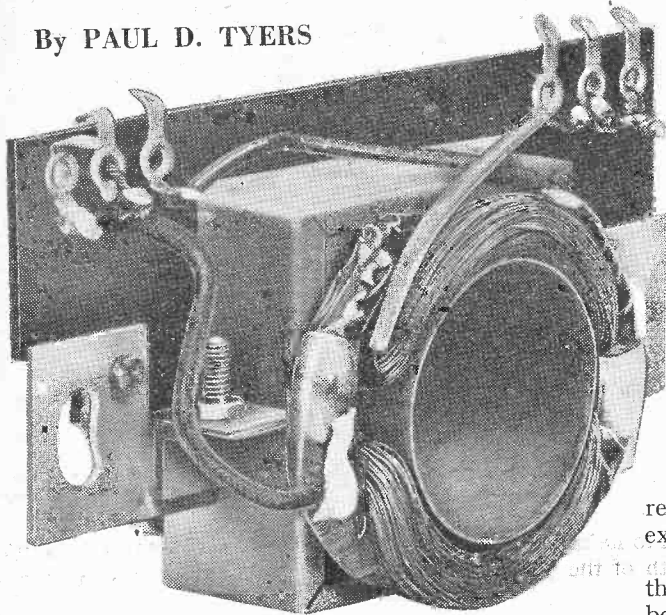

This photograph shows a finished scanning coil assembly.

THESE notes on scanning coil construction are based upon the results of much experimental work initiated with the object of determining suitable mass production methods. The suggestions put forward are modifications of the system adopted, so as to be suitable for individual construction without the use of expensive equipment.

recommendation if such exists.

THE production of a satisfactory scanning coil is determined by two separate and distinct factors.

The first is the electrical design of the coil, and the second is the means adopted to ensure that it has the desired shape. The former requirements are a function of the electron-optics of the tube, and the electrical constants of the scanning amplifier and associated equipment. These determine the optimum dimensions of the coil, and it is not proposed to give any consideration to this aspect of the subject in the present article, but to confine our attention to means for constructing the coil so that it conforms to the required specification.

It is believed that most tube manufacturers will give some indication of the general nature of the necessary coil, which means that the experimenter can at least start his investigation from the half-way

More than anything else, in the early days of television the bogy of scanning-coil construction was probably responsible for the long adherence to electrostatic tubes. Many designers considered that it was not an economic proposition to make a small quantity of all-magnetic receivers. Should any experimenter who is contemplating fixing up an all-magnetic receiver be tempted to listen to such heretic doctrine he may rest assured that for a negligible outlay he can make an entirely satisfactory set of coils.

Scanning coils can be divided into two groups, those for long tubes and those for the so-called short tubes. The shorter the tube the more difficult is it to make the coils, and the greater must be the care exercised in paying attention to small details. The short tube appears to have come to stay, and, therefore, most interest is likely to be in coils for it, but the experimenter who prefers the easier job should use a long tube. Other things

being equal, the only disadvantage of the long tube is its length. Off-set against the extra few inches of tube neck is the advantage of an easily made set of coils, the use of less scanning power, smaller valves and the abolition of the iron yoke.

The first point to realise before making a coil is that when a current flows through a coil the field or deflecting force is at right angles to the windings. If, therefore, we want to deflect the cathode-ray beam uniformly any old roughly made coil badly aligned on the tube neck will obviously produce a distorted scan. We must aim at symmetry and some degree of precision. Winding

up a pancake coil around a match box, and then trying to persuade it to assume the desired shape by bending with the fingers won't get us very far, even if all the turns don't fall into a jumbled mess.

Fig. 1 shows three coil forms. The first is what one might term the theoretical shape. It is simply a flat coil lying, of course, parallel with the plane in which the beam is to be deflected. Such a coil used with a short tube would require very high ampere-turns. The effective field is increased in practice by slightly bending the coil round the neck of the tube as shown in the second position, this being suitable for a long tube. The third posi-

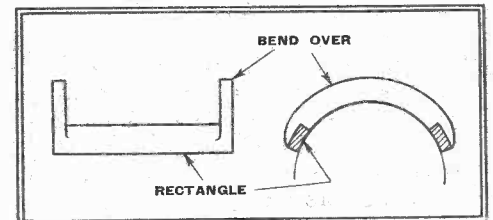

Fig. 2.—The general shape of a scanning coil is shown by these drawings.

tion shows what is required for a short tube.

Coil Shape

This bending of the coil brings with it a number of conditions which have to be satisfied. A good indication of the general shape of the coil is given in Fig. 2. First of all it is necessary that what we may call the effective scanning portion is substantially rectangular. This applies to both halves. The two rectangles are parallel, thereby making the coil symmetrical. The rectangular form must be continued to the ends, the bend-over being at right angles. This applies particularly to the corners. A coil having the form shown in Fig. 3, while not only tending to give a technical scan, will give a distorted one which is far worse, since loss of scanning field can be compensated for by increasing the power, whereas a distorted field cannot be easily rectified.

Inspection of Fig. 4, which is a cross-section through a coil, shows that there is a marked difference between the scan

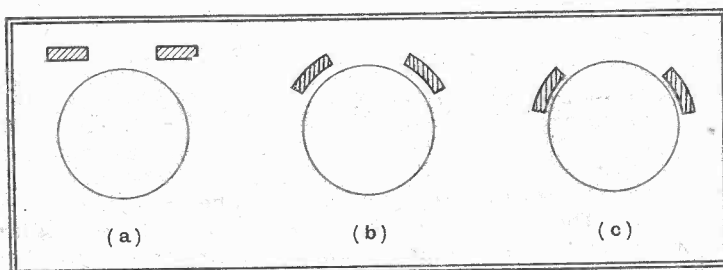

Fig. 1.—These drawings indicate the coil positions; (a) is a theoretical case, (b) is for a long, and (c) for a short tube.

mark. In any case, however, the writer has had experience of satisfactory coils for tubes made by three well-known manufacturers, and details of the exact sizes and number of turns employed are included. It should be pointed out that the sizes and turns have been determined by the writer, and they must not be considered as the manufacturers' official

Scanning Coil Construction—

section and the bend-over. It is easy to see that if we wound a coil of uniform thickness and tried to bend it to the desired shape with a semi-circular bend-over, all the turns in the bend-over would require different lengths since they form a number of semi-circles of increasing radii. There are several methods of simplifying the problem by some form of pre-shaping carried out in the winding process, which really amounts to using a tapered or stepped former. Even when the coil is wound to the desired shape, when it comes off the winding mandrel much has yet to be done.

It is wound as a flat coil of varying thickness and has to finish as a most complicated form having precise dimensions. It is very obvious that some moulding or

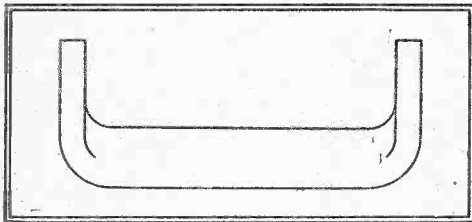

Fig. 3.—A coil with rounded corners should be avoided, for it reduces and distorts the scan.

similar operation will have to be carried out. No doubt the necessity for winding to a special shape followed by a forming or moulding operation will give the impression that the construction of a scanning coil is about the last thing which the experimenter should attempt. However formidable the process may sound, it is actually exceptionally simple. No complicated or expensive machinery is necessary, and provided the experimenter has available a few simple tools and is prepared to spend more time making the necessary formers than in winding the actual coils all will be well.

In considering just what has to be done we cannot do better than refer to the shape of the finished coil shown in Fig. 2 and try to imagine what it would be like if squashed flat. The resultant shape would obviously be that which it should assume when it comes off the winding mandrel. Fig. 5(a) shows a pair of coils arranged round the tube neck. It will be noticed that the edges do not touch; the gap dis-



Fig. 4.—This photograph shows a cross-section of a line coil. Note the short right-angle bend between the rectangle and the bend-over. Some of the turns have been displaced a little in the operation of cutting through the coil.

tance may well be of the order of one-quarter of an inch. Fig. 5(b) shows the

appropriate shape of the coil as a flat development on half the tube neck. Assuming that we have been given the optimum coil length and width of the rectangle we can now determine the dimensions of the mandrel. Here we can fall into a trap which results in the production of a most irritating coil, one which is more or less of the correct shape but has badly rounded corners or alternatively one which for an apparently inexplicable reason is much too small.

Dimensions

The really critical dimension is the inside window of the developed scan coil. Referring to Fig. 5(c), if the peripheral distance L , between the inner edges of the rectangles is taken as the inside dimension for the developed coil former all would seem to be well. Actually, however, the coil has thickness, and when bent to the required shape a distance of L' is necessary. In addition, in order to bring about the necessary right-angle bend, and allow the rectangular scan portion to lie correctly on the tube neck, the length of the bend-over has to be greater than the distance L . It is better to err on the long side rather than the short, as any tightness will prevent the scan portion from lying correctly on the tube neck, and the coil will assume the shape of Fig. 6, which is disastrous.

Fig. 7 shows the arrangement of the winding mandrel, which should be built up

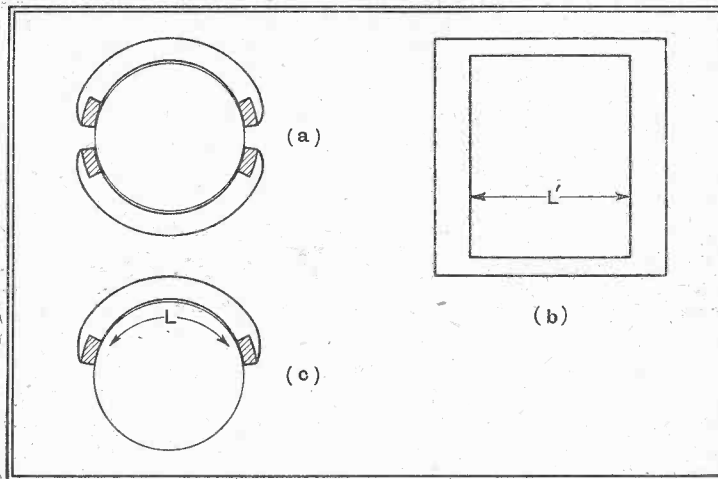

Fig. 5.—A pair of coils is sketched at (a) to show the gap allowed between them; at (b) is a drawing of the flat coil, and (c) shows it on the tube.

in the following manner, using either metal or a hard close-grained wood. There are five main parts. First of all there is the core piece. The length is that of the peripheral distance plus the extra which is necessary as just explained. Actual dimensions are dealt with later in a table of suggested dimensions. The width is obviously equal to the length of the rectangular portion of the coil. The thickness is determined by a number of factors which really do not lie within the scope of the present article, as the thickness controls the number of turns. In practice it works out to something of the order of 2 millimetres. There is one very important

point to remember when making the core piece. It is essential to give it a really good "draw" or taper. What is necessary is shown in an exaggerated form in Fig. 7(a). This is necessary to assist in removing the coil from the former when

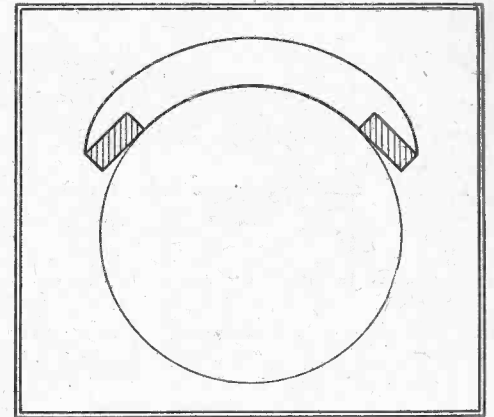

Fig. 6.—This diagram illustrates the effect of using too small a window in the coil.

wound. If there is any tightness the inner turns will drag and the coil will be spoilt.

The next part is the bed, which consists of a flat piece of either metal or very close-grained hard wood. The width of this is equal to the width of the core, and the length is not critical so long as there is ample winding space. To the sides of the bed piece are fixed two taper pieces. These are approximately 45 degree fillets, and are best set back from the edge of the bed by about one thirty-second of an inch. Lastly, there is the cheek which is a flat plate, again made of metal or hard wood.

Unless several vital points are attended to in the construction of the winding jig, trouble will ensue. In the first place we have to spin the mandrel round exactly on the centre. If it is not centrally mounted, the winding tension tends to be unequal, and the resultant coil is asymmetrical. In the photograph showing one of the experimental mandrels used for making laboratory coils the mandrel has been provided with a central tube which fits conveniently into the coil winder, but any form of tube or spigot may be used to suit the winding means available. A small hand-drill clamped in a vice can be used perfectly successfully as a winding machine, in which case the mandrel should have a central spigot which should be as large as possible consistent with the size of the chuck.

The next point to observe is that the corners of the cheek, bed and core should have no sharp edges. Those on the inside

Scanning Coil Construction—

of the bed and cheek can be considerably rounded. In the case of the core, there must not be too much rounding. Sufficient smoothing to prevent cutting the inner turns is all that should be used.

In the mandrel illustrated in the photo-

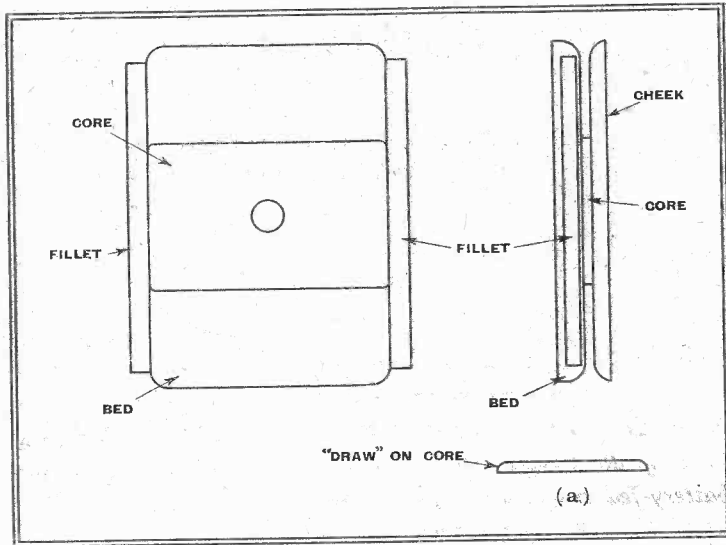
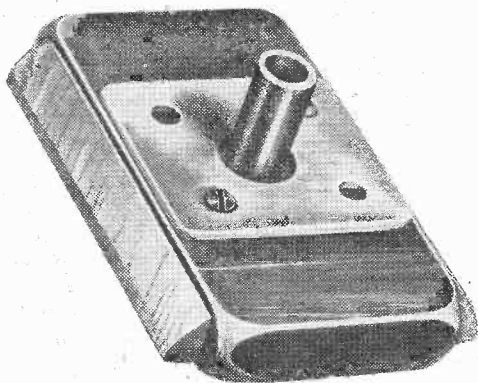

Fig. 7.—These diagrams show the details of the winding mandrel. The core and bed corners are slightly rounded to avoid damaging the wire.

graph the core and cheek are held on studs, but it does not matter much how the assembly is held together so long as it is possible to remove the cheek without difficulty. If desired the core can be permanently fitted to the bed.

It has been stated that it is essential to maintain the rectangular form of the active scanning portion, and it is obvious that a loose coil removed from the winding mandrel must be the most awkward thing imaginable to bend by hand into a complicated form and still maintain an accurate rectangular form. Once more a little constructional work in the manufacture of a bending or moulding jig will be amply repaid.



This photograph shows the winding mandrel, with an extension tube for supporting it while winding.

The following steps in the production of the final coil have been modified from the mass production system so as to be within the constructional scope of the experimenter. Briefly, the system is to bend the

bunched up sides at right angles to the rectangular portions, and apply a fixative to the rectangular portions only, and when partially dry transfer the coil to a mould where the coil is finally formed to the desired shape.

As a fixative use can be made of either a cellulose varnish or a wax, in which case heat is necessary. For the construction of a single set of coils cellulose varnish is probably the most convenient. The solvent must not be acetone, which, although quick drying, attacks many insulating enamels used on the wire. Xylol is similarly best avoided, the best solvent being amyl acetate, which, although slower drying, is perfectly safe. A commercial cement such as Durofix thinned down with amyl acetate is very

satisfactory and will hold the turns together with reasonable security.

(To be concluded.)

“The Multipactor”

A VERSATILE ELECTRON MULTIPLIER

THE electron-multiplier is a particularly useful device for amplifying the relatively weak currents produced by the action of light on a photoelectric surface, such as silver-oxide and caesium. The primary electrons first set free are projected at high speed against a series of “target” electrodes, where they liberate secondary electrons, and so “multiply” themselves progressively. In this way it is possible to convert an original micro-amp or so into as many amperes, though it is not so easy to maintain a straight-line relation between input and output.

In the “multipactor” shown in the drawing (Patent No. 487610) the production of secondary electrons is increased and controlled by a number of perforated “target” electrodes T, which are more or less equally spaced along the

Arrangement of electrodes in the “multipactor” electron multiplier.

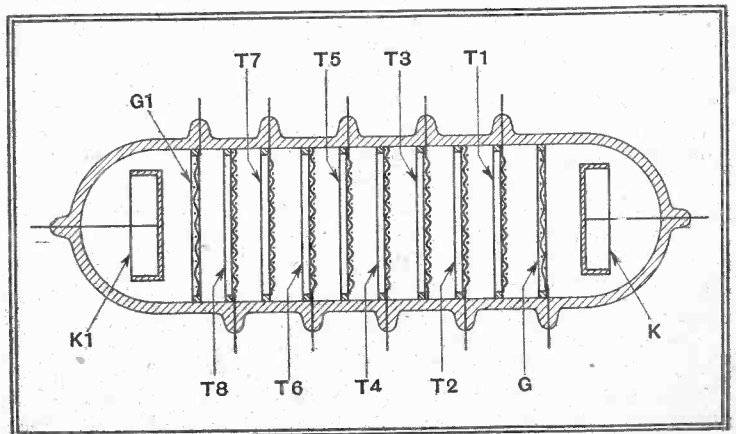

length of the tube, and are progressively biased to give a uniform potential gradient. The photo-sensitive cathode K is followed by an “open” grid or screen G, and then by a series of eight perforated targets T1 . . . T8, which carry increasingly positive voltages from right to left. The targets are caesium-coated and give off from six to eight secondary electrons for every impact of a primary.

1,250,000-fold Amplification

The secondary electrons are released at a comparatively low velocity, and under the action of the adjacent lines of force are uniformly diffused so that only a very small number fail to make contact. Actually, only one in 65,000 of the electrons from the cathode K will travel straight through the tube without striking a target. Under these conditions a maximum amplification of a million and a quarter can be obtained with a substantially linear response within a given range of biasing voltages.

A screen G1, similar to the grid G, is placed in front of the output electrode K1, so that the tube is symmetrical and can be used to amplify currents of any frequency applied across its terminals. For wireless reception the incoming signals are applied to the cathode K and the grid G is earthed through a leak resistance. In this case the multipactor acts as a combined rectifier and amplifier. Certain of the electrodes can be used to produce local oscillations for superhet reception.

Advice to Inventors, by K. Trevellyck Hardman. Pp. 64. Published by Frederick Warne and Co., 1, Bedford Street, Strand, London, W.C.2. Price 2s.

THIS book does not set out to tell the inventor how to fulfil the various formalities necessary to take out a patent. It is written from an entirely different angle, and explains the many pitfalls which beset the path of the inventor in the actual marketing of his invention, and gives a great deal of useful information concerning whom to approach and the best manner of doing it.

Lanchester's “Potted Logs,” by F. W. Lanchester, LL.D., F.R.S. Parts I and II. This booklet comprises log tables in antilog form, the numbers being given to eight figures. Tables of both common and natural logarithms are included. Pp. 27. Published by Taylor and Francis, Ltd., Red Lion Court, Fleet Street, London, E.C.4. Price 2s.

Low-power Transmission

LONG RANGES ON ONE WATT

By W. OLIVER (G3XT)

EVIDENCE of a growing interest in low-power transmission is afforded by the fact that, of 169 British amateur stations with which the writer has been in contact during the past five months, over 50 were using well under ten watts, the lowest being half a watt. All these contacts were established on the 7 Mc/s band, using ultra-low power at G3XT, as the supply, up to the present, is derived solely from batteries, and rarely exceeds two watts. Most of the work at this station has been done with an input of one watt (10 mA at 100 volts), and a good many successful contacts have been maintained with the HT voltage still further reduced, bringing the input down to barely half a watt.

Mains supply will shortly be available at G3XT, but even then it is proposed to continue low-power experiments, as the results which these have yielded are of considerable interest and, in many cases, little short of amazing. It is felt that many more amateurs would experiment with low power if they fully realised its possibilities, and the purpose of the present article is to draw attention to these possibilities by giving a detailed analysis of the results obtained at this station. From the data available it should be easy for any amateur contemplating low-power work to form a fairly accurate idea of the results he can expect to get with an input of the order of 1 to 2 watts.

The consistency of the results obtained at G3XT over the five-month period under review, in widely varying conditions and always with a comparatively poor transmitting aerial

at a location only 50 feet above sea level, seems completely to disprove generally accepted ideas and should remove any doubts in the minds of amateurs who are wondering whether low-power working is any good.

The 7-Mc/s band has lately been alternating a great deal between periods of what might be termed "deep depression," in which conditions are so poor that scarcely any stations are audible, and periods of liveliness in which so many stations take advantage of the temporarily good conditions that the band becomes congested with signals packed "three deep" on every available channel.

These difficult circumstances put low-power transmission to a severe test, and it is remarkable that, in the five months under review, communication was established with 211 different stations (42 Continental in addition to 169 British) using only a watt or two of power. A large proportion were worked more than once, and, in some cases, regular schedules were kept successfully; consequently the total number of contacts effected during this period amounts to three hundred and fifteen.

The reports on G3XT's signals received in the course of these 315 conversations are summarised concisely in the following table, which shows the comparative results at a glance.

In this table use is made of the Readability-Strength-Tone code employed by all amateurs, and usually known as the RST code. Only the R and S portion are actually shown in the table, tone being omitted. In this code signal strength is graduated from S1 ("just audible") to S9 ("extremely strong"). Owing to various factors such as interference and poor tone, readability does not bear any constant ratio to signal strength. In the RST code it is graduated from R1 (audible but unreadable) to R5 (readable without any difficulty).

Strength (S)	Readability (R)					Totals
	5	4	3	2	1	
9	1	—	—	—	—	1
8	11	—	—	—	—	11
7	57	1	2	2	—	62
6	74	8	4	1	—	87
5	83	18	3	1	—	105
4	17	8	4	—	—	29
3	5	2	7	—	—	14
2	1	2	—	—	—	3
1	—	—	2	1	—	3
Totals	249	39	22	5	0	315

where more than one report was received when working a station, the lowest of the reports has been adopted for the analysis table. For example, in the case of signals reported RST 5 6/4 9 ("Perfectly readable, good signals, fading to fair signals, purest D.C. note") the report is classified in the table under "Readability 5, Strength 4," the 4 representing the minimum signal during fades. Peak signals have also been ignored, e.g., if the report just quoted had been RST 5 4/6 9, indicating that the steady level of signal strength was S4 and that it occasionally "peaked" to S6, it would have been entered in the table as RST 5 4 9. The third figure in these examples

refers to tone, which, as already mentioned, we are not taking into account in the table. It will be seen from this explanation that the table can be taken as giving a reliable indication of the consistent results obtained, all freak results and flukes due to temporary periods of exceptionally favourable conditions having been ignored.

It will be seen, from a study of the table, that the average strength report is a little over S5 ("fairly good signals"). Only one steady S9 ("extremely strong") report was received during the five months, although a transitory peak-strength of S9 was actually reached on several occasions, not recorded in the analysis. The vast majority of the reports (105) were S5; then come S6 ("good signals") with 87 reports; S7 ("moderately strong signals") with 62 reports, and S4 ("fair signals") with 29 reports.

As regards readability, which is really more important for practical purposes than signal strength, it will be seen that the reports show a remarkably high standard. No doubt the tone of the CW note played an important part in securing this, since the beautifully clear T9 note of a crystal-controlled and battery-powered transmitter is 100 per cent. readable under conditions in which a rough note from a "chirpy" mains-operated transmitter of the electron-coupled oscillator type would be almost unintelligible.

"Perfectly Readable" Signals

A glance at the table shows that no fewer than 249 out of the 315 reports gave the readability as R5 ("Perfectly readable"). Now, there is obviously the possibility that a proportion of these reports might be more flattering than accurate. We are all familiar with the type of amateur who reports signals as being RST 589 without stopping to think, and adds to this assurance of "perfect readability" the naive request: "Pse rpt all, OM, I missed the lot!"

To verify as far as possible the accuracy of the reports, therefore, the writer has gone carefully through the records of messages received, and as practically every CW message from each station worked has been written down and kept at G3XT, it has been possible to abstract much more information than is evident from the nominal reports alone. These records show quite definitely that a very high pro-

THIS article, written before the ban on amateur transmission in Great Britain was imposed, describes some of the results obtained with a battery-fed transmitter of exceptionally low power, operating with an extremely simple aerial system.

Low-power Transmission—

portion of the transmissions from G3XT have been received "100 per cent. solid copy" by the stations concerned.

It should, however, be frankly admitted that most of these "100 per cent. solid" reports have been given at times of the day when interference on the 7-Mc/s band is not at its height. Those amateurs whose working hours make it impossible for them to transmit except in the evenings or on Saturday afternoons and Sundays must not expect to get anything approaching the results indicated in this analysis. When conditions are good, and there are scores of stations active on the band, it is difficult to establish communication at all on ultra-low power during the peak hours of interference. But if conditions are poor and a great many stations have closed down to await an improvement in conditions, leaving the band comparatively clear, the ultra-low power transmitter—quite contrary to what one might expect—stands a much better chance of success. This brings us to a feature of outstanding interest in connection with the results obtained at G3XT.

500-mile Range

On many occasions communication has been maintained, with "solid copy" both ways, between G3XT and stations at distances ranging from 3 miles to 500 miles or more, under conditions so poor that the band seemed virtually "flat" and very few stations were audible at all. Two further facts regarding the 7-Mc/s band under these conditions are remarkable. In the first place the stations worked during periods of very poor conditions have been mostly low-power stations, and, secondly, when higher-powered stations have been audible their signal strength has often been no better—and occasionally worse!—than that of low-power transmitters at a similar distance.

Experience at G3XT has repeatedly shown that patient calling and careful

searching at times when the band appears to be hopelessly "dead" will frequently be successful in "raising" a station, and that, once contact has been established, it can generally be maintained with "solid copy" in both directions for a long time, owing to the absence of interference. Admittedly, signals are weak under these "flat" conditions, but an S3 signal "in the clear," with little or no fading and a quiet background, is far more easily readable than an S7 or S8 signal under heavy interference from an over-modulated telephony station.

From the results obtained at G3XT it would certainly seem that the only real drawbacks to lower-power transmission are that it is seldom able to hold its own against very heavy interference, and that signals from a low-power station suffer more from fading than those radiated by a higher-powered transmitter.

CW telegraphy was used in about 95 per cent. of the instances referred to in the analysis table. The remainder were telephony. In order to modulate adequately with an audio power which had been minimised to avoid overrunning the batteries, it was necessary to reduce the power-amplifier input to a lower value even than that used for CW work. With such low power the telephony was no match for heavy interference, but on a clear channel some surprisingly good results were obtained.

The transmitter used at G3XT for these experiments is as simple and straightforward as it well could be; it uses receiving-type valves in an ordinary, conventional crystal-oscillator power-amplifier circuit. A pentode (as in Fig. 1 (a)) and a super-power triode (Fig. 1 (b)) have been tried with success in the crystal oscillator stage, but for the power amplifier a super-power triode (arranged as in Fig. 2) has been used throughout the experiments.

For the occasional excursions into telephony a small battery-powered modulator was added; but the continuous current-drain from the batteries when

working telephony means that this is not a paying proposition and, therefore, it is hardly worth while going into further details about the modulator here. When the triodes were used in both CO and PA stages, keying was done in the PA, leaving the CO running continuously so that it could be adjusted for maximum efficiency without risk of instability or a chirpy note.

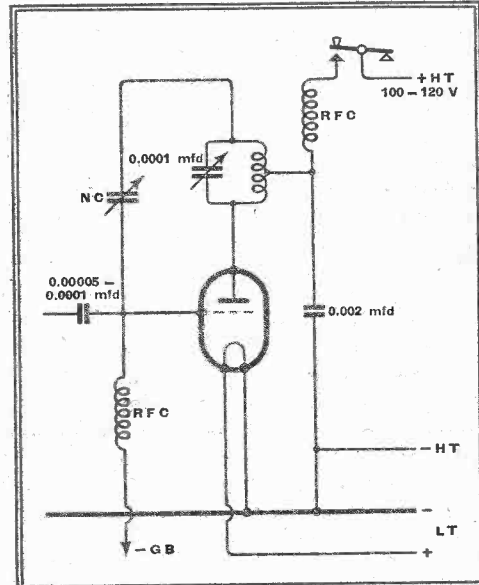

Fig. 2.—Connections of the power amplifier stage.

If one is constructing a low-power transmitter to one's own design, one's aims should be: (a) to keep the wiring short and direct in parts of the circuit where this is important; (b) so to arrange the layout that there is no unwanted interaction (e.g., between the CO and PA stages, or between the CO and the aerial circuit—this latter form of interaction being liable to produce a spacer-wave if the keying is being done in the PA stage); (c) to achieve low-loss construction so as to conserve the limited energy consequent upon so small a margin of power.

As regards the inductance, capacity and resistance values for the various components, these do not seem to be very critical in practice, but there is, of course, an optimum value for a given set of conditions, and the nearer one can approach to this the better the results are likely to be. One can arrive at the optimum value by calculation or by practical experiment.

Broadly speaking, however, inductances which resonate at 7 Mc/s with 50 m-mfds. of capacity in circuit (i.e., a 0.0001 mfd. variable condenser half enmeshed) will be found suitable for a power approximating to that used at G3XT. With regard to the fixed by-pass condensers, 0.002 mfd. is suitable for 7 Mc/s. The best value for the CO grid resistor with any particular oscillator valve can be found easily by practical experiment.

Particular care should be given to wiring and layout in the PA grid circuit, as it is easy to spoil results by, say, undue capacity to earth at this point. A fixed or variable condenser (mica or air dielectric) with a maximum capacity of 0.0001 mfd.

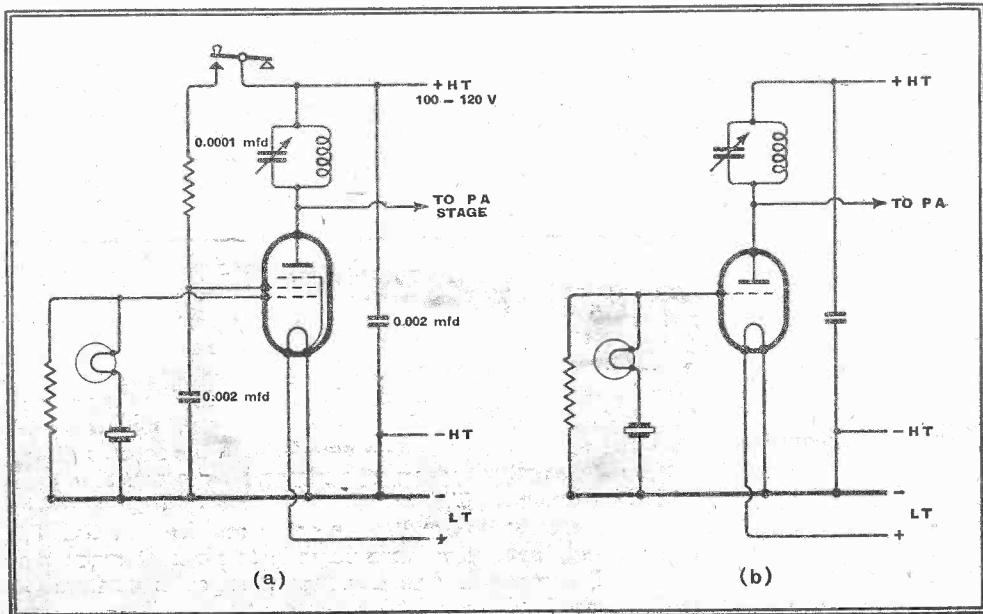

Fig. 1.—Alternative use of pentode or triode in the crystal-oscillator stage.

Low-power Transmission—

can be used for the capacity-coupling between CO and PA, but the leads to it should be short and well away from earthed metal such as the chassis.

As to aerials, various well-known types of transmitting antenna have been tried at G3XT, but none of these so far has been erected at a height exceeding 25 feet. A simple 66-ft. aerial of the end-on type adjusted to resonance, of course, proved satisfactory, and was used for a while. As, however, plenty of space is available here, a full-wave antenna for 7 Mc/s was subsequently erected and this (shown in Fig. 3) was employed during the greater part of the period under review.

For reception a fairly low inverted-L aerial (also shown in Fig. 3) has been used throughout. Quite recently it was found by chance that this is surprisingly effective as a radiating antenna! With the full-wave antenna lowered to the ground, and the receiving aerial connected to the transmitter, communication was effected with various stations at distances up to five or six hundred miles, and the signal-strength reports were fully equal to those obtainable with the full-wave antenna.

It will be quite evident from a glance at Fig. 3 that neither of these aerials as erected at G3XT has any pretensions to theoretical efficiency, yet it is equally obvious, from the analysis of reports, that

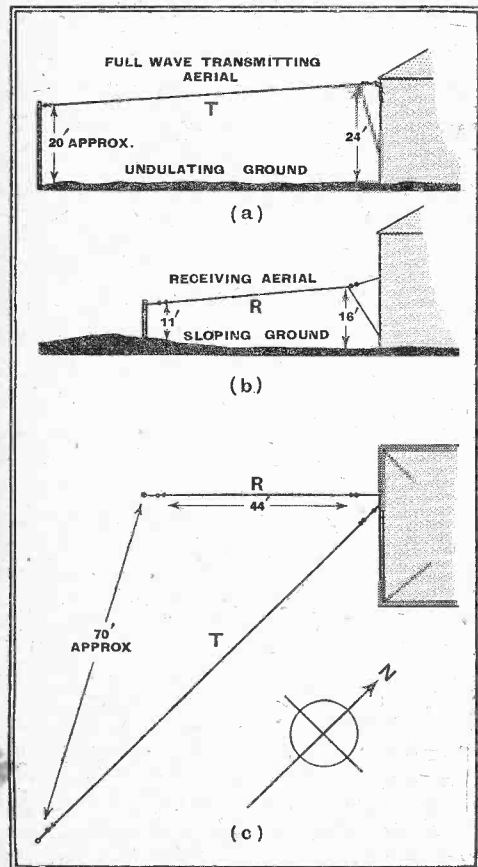

Fig. 3.—Elevations and plan showing general arrangement of transmitting (T) and receiving (R) aerials.

they work surprisingly well in practice. The results obtained would seem to disprove the widely accepted idea that a high and efficient aerial is essential to success in low-power transmission.

Model 40 "Avometer"

FORTY RANGES AND CIRCUIT PROTECTION BY MEANS OF A CUT-OUT

THIS instrument takes the place of the 36-range Avometer and occupies an intermediate position between the DC Avometer at 9 guineas and the Model 7, 46-range, Avometer at 16 guineas.

Like the Model 7, the new Model 40 is fitted with a protective cut-out instead of the calibrated fuse which was required in the 36-range instrument. The cut-out is an ingenious device depending for its action on the inertia of the pointer. A spring coupling between the pointer and the moving coil permits relative movement between these two parts when the moving coil is accelerated abnormally under overload and releases a pawl, which trips the circuit breaker. The cut-out may be instantly reset, after first removing the meter from the

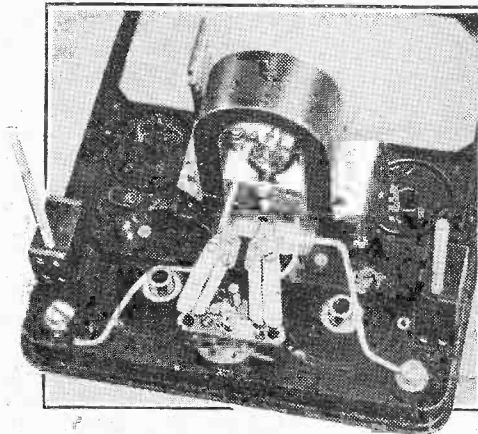

An automatic cut-out protects the movement in the Model 40 "Avometer."

external circuit as a precaution, by depressing a button on the front panel which occupies the same position as the fuse in the earlier model.

In addition to the inertia control which operates when the pointer is in an intermediate position on the scale, the cut-out is also brought into action by excursions of the moving coil or pointer beyond the limiting stops. Thus the meter is still fully protected if it is working near full-scale deflection or if DC of the wrong polarity is applied when the pointer is at zero.

Of the four ranges which have been added, two are for alternating current (0.6 mA and 0.12 mA), and two for DC voltage (0-240 v. and 0-480 v.). The 0-100,000 ohm range, for which external batteries are required in the DC Avometer, is operated

Self-contained batteries are provided for resistance readings up to 100,000 ohms.

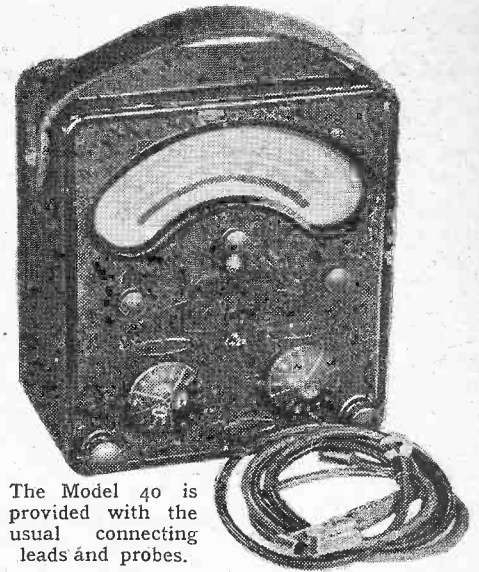

The Model 40 is provided with the usual connecting leads and probes.

in the Model 40 by an internal 9-volt battery, which is additional to the 1.5 cell normally included for the 0-1,000 and 0-10,000 ohm ranges. By using AC or DC mains, or any other source between 80 and 250 volts, the meter can be adjusted to measure resistances up to 1 megohm. Readings are taken on the 120-volt (AC or DC) range, and the test resistance is connected in series with the supply and the meter.

The complete list of ranges is as follows:—

DC Current	DC Voltage	AC Current	AC Voltage	Resistance
0-6 mA.	0-60 mV.	0-6 mA.	0-6 V.	0-1,000 ohm
0-12 "	0-120 "	0-12 "	0-12 "	0-10,000 "
0-60 "	0-600 "	0-60 "	0-60 "	0-100,000 "
0-120 "	0-1.2 V.	0-120 "	0-120 "	0-1 megohm
0-600 "	0-6 "	0-600 "	0-240 "	
0-1.2 A.	0-12 "	0-1.2 A.	0-480 "	
0-6 "	0-60 "	0-6 "	0-600 "	
0-12 "	0-120 "	0-12 "	0-1,200 "	
	0-240 "			
	0-480 "			
	0-600 "			
	0-1,200 "			

The total resistance of the instrument is 200,000 ohms. A press button on the centre of the front panel doubles the sensitivity and is of great value in reading accurately deflections on the normal ranges which fall in the earlier part of the scale.

Each instrument is calibrated to B.S. First Grade standards of accuracy, and the meter magnets, which are of cobalt steel, are aged before assembly.

The price of the Model 40 is 14 guineas, and the makers are The Automatic Coil Winder and Electrical Equipment Co., Ltd., Winder House, Douglas Street, London, S.W.1. Leather carrying cases with handle and shoulder strap are available, price 25s.

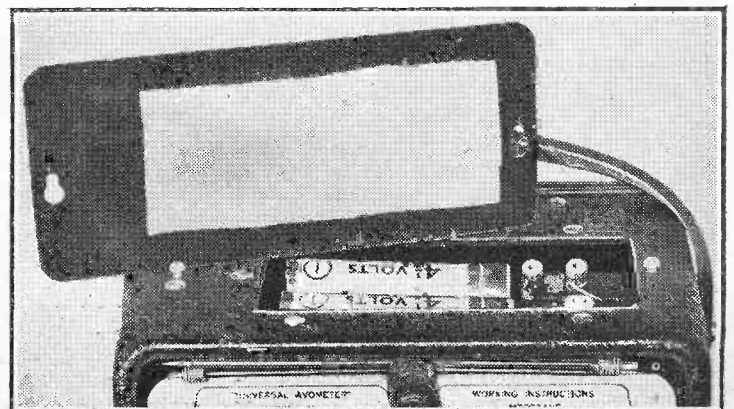

Wireless in the Tropics

WHERE LIGHTNING IS TREATED WITH SCANT RESPECT

IT is with interest I have been listening on the short-wave programmes under British summer conditions, and comparing them with tropical reception experiences over the last few years. As a result, the opinion has been formed that, even during thundery weather, conditions in Britain are infinitely better than anything we ever come across in Malaya and the East Indies. The Dutch East Indies, our next-door neighbours, are one of the places where a large amount of atmospheric interference heard in other parts of the world originates.

It is a relatively common occurrence to have equipment damaged, not so much by direct lightning discharges hitting aerials, as by surges caused by strong induction in power lines. In fact, it is not unusual to find the aerial system undamaged after a receiver has been "struck" and the power end ruined.

Sparks from the Aerial

With a storm five or six miles away, it is often possible to draw sparks up to $\frac{1}{4}$ in. long from the aerial. It is interesting to watch them "build up" in strength until the tension is released by a lightning flash either from cloud to cloud, or cloud to earth. This game is not so dangerous as it appears, and yet carries an element of risk which makes it a practice not to be indulged in too frequently, and only if one has experience of the "habits" of one's local thunderstorms.

Some localities in the tropics are struck much more frequently than others, and the old adage that "lightning never

strikes twice in the same place" does not hold, and it is common to find

The contributor of this article has found, contrary to the usual belief, that more damage is done by surges induced into the mains than by lightning discharges on to the aerial. A surge absorber—the Ferranti Type M is shown—is useful in such circumstances.

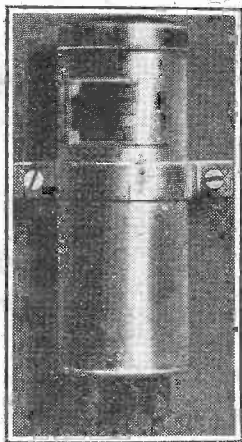

houses which are struck regularly two or three times a year during April or May—which is the worst time of year for electrical storms. A cure, which the writer

By

"COLONIAL"

Courtesy Companhia de
Mocambique
Beira Wireless Station.

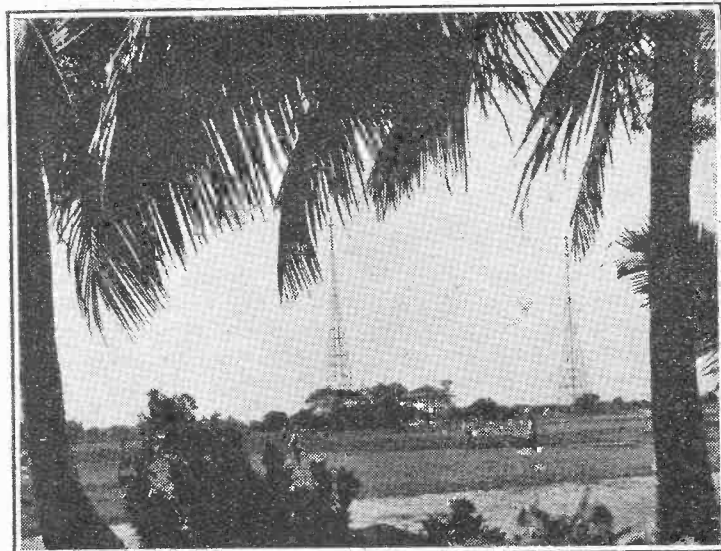

has installed in several instances, and which it is claimed has been a complete cure in two cases, is the use of a high galvanised steel pole made of ordinary galvanised gas grade tubing (4in. x 18ft., 3in. x 18ft., 2in. x 18ft., and 1 $\frac{1}{2}$ in. x 18ft.), making a pole, one end of which is in the ground about 4 to 6 feet, and between 60 and 70 feet high. The aerial is attached in the usual way to the top, but the presence of this earthed pole on the high ground near the house appears to take

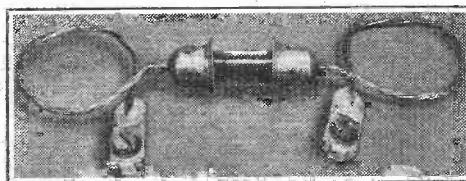

Courtesy Belling and Lee

The fitting of a lightning arrester at the aerial lead-in is a wise precaution.

direct hits without damage, or to form a conductor which releases tension around the house to such an extent that charges do not build up sufficiently to form a flash. It should be mentioned that on estates the bungalows are usually on small hills, and may be two or three hundred feet above the surrounding country. The pole being higher still, has the effect of eliminating flashes or reducing their occurrence.

Inside Damage

Surges on power lines usually cause damage inside buildings by bursting bulbs, destroying switches and wiring, and similar action. Switch porcelains may be "powdered," leaving all the brass connections hanging loose, and the opening of main switches is not enough protection, as the surge reaches, at times, sufficient strength to jump the gaps.

Lightning arresters of the surge absorber and also of the pellet type have

proved very effective forms of protection against this type of damage, protecting the radio receiver, house wiring and all appliances such as cookers, geysers and irons, etc.

Damage by a direct hit naturally results in a different type of damage, and in no instance in the writer's experience was the radio receiver damaged when the aerial was struck.

Without detailing the several direct hits the writer investigated, it is sufficient to say that in each of four instances the flash or charge, after coming down the aerial, jumped to the building before reaching the receiver, and usually in the vicinity of the point where the aerial lead-in entered the house.

Electric Shock

The results here consisted of physical shock to the unfortunate inmates of the house—at least in each case the people claimed to have felt no ordinary electric shock—pictures knocked off adjacent walls, timber beams in the walls and floors split, weather boarding and floor boards shivered as by an internal explosion, cracks in brickwork pillars, and in one case a hole 18in. was punched in an unreinforced concrete floor 4in. thick.

The only effective protection which can be offered in this instance is the installation of a good type of arrester on the lead-in, and the use of a high steel aerial mast, properly earthed and bonded, and lightning conductors at all ridges and roof corners.

The question of lightning protection has only been treated from the private radio owner's viewpoint, but in a country like Malaya it is a serious problem for all electrical supply undertakings, as most of their supply lines are overhead, except in the centres of one or two of the larger towns. However, this does not come within the scope of this article.

Television Progress

REPORT OF THE OLYMPIA CONVENTION

LAST week reports were given of three of the conventions held during the Olympia Exhibition, and we now give the fourth and last. Dealing with the subject of television, it aroused considerable interest in view of the wide variety of problems which were discussed.

IN opening the 4th convention, dealing with television, the chairman, Mr. Barton-Chapple, said that research in television stands on the shoulders of the scientists of yesterday. Eleven years ago 30-line television was shown by Baird; it had developed greatly since then and the rate of progress had been accelerated in the last three or four years.

He then called on the first speaker, Mr. R. G. Clark, of Mullards, who stressed the fact that research is the backbone of television. He spoke of the value of intelligent observation by the public, and said that it must be realised that those engaged in television were creating a new system. There was a fundamental difference between seeing and hearing by wireless, and television could not supplant ordinary broadcasting.

He felt that insufficient credit had been given to those engaged on the production side; the presentation of programmes was a new art, and important developments must be expected in the future.

On the technical side, Mr. Clark emphasised that the design of transmitter and receiver were closely interlinked, and that the most important matter was the question of definition. The standard was determined largely by the carrier frequency and the range of frequencies was limited. The use of a lower frequency would lead to trouble from interference and multiple images, and the definition would be lower. A higher frequency would still present the multiple image problem and would give less range, while the generation of the necessary power would be very difficult, if not impossible. He concluded that the present standard represented the middle course between prudence and rashness, and this was confirmed by the fact that other countries have adopted similar standards.

Dealing with the problem of national coverage, Mr. Clark said that many transmitters would be needed even for a limited coverage, and that the provision of separate studios was not favoured on account of their cost. This left the possibility of linking the transmitters to a single studio either by HF cable or by UHF radio links. The former was not simple, and its cost was high, while the latter were liable to interference.

On the receiving side the past year had been characterised by real engineering

development. Until recently the number of valves needed had been prohibitive, but this had been solved by the production of special types which simplified receivers and gave them greater reliability. The CR tube, too, had been improved in every way—it was more compact, had a smaller and more uniform spot, had greater sensitivity, and a better screen of improved colour and higher luminosity. Controls on receivers had been reduced to a minimum, and the operation was now simpler than that of a broadcast set.

Mr. T. C. Macnamara, of the B.B.C., dealt with transmitting problems. Considerable improvement had been made in details in the last year, and the most important was the introduction of a second studio. This still gave inadequate space, but it greatly eased production problems, it doubled the time available for full-dress rehearsals, and it greatly eased matters in the case of a defect in studio equipment.

into the other, it allowed the superimposition of pictures, and by permitting fading between a studio and an outside broadcast it ironed-out the flashes experienced in the early days. It had done more to increase the slickness of production than anything else.

Cameras had been improved; the Marconi-E.M.I. tubes gave better definition and contrast than a year ago, and their colour response was more consistent. Studio lighting was better; much knowledge had been gained from the practice of film studios, but television had its own problems. The reason for bad lighting, which he admitted did occur at times, was inadequate time for full-dress rehearsals.

Outside Broadcasts

It was generally agreed that outside broadcasts were the most important, for there was no other visual medium with a completely topical flavour. The B.B.C. now had two O.B. units. One of the difficulties was that while three suitcases of apparatus might suffice for a sound outside broadcast, television needed four vans the size of large passenger motor coaches, and weighing 30-40 tons; a large amount of power was also needed.

Much work had been done to speed up



The central control room of the London television station which handles the outputs of the two studios as well as those coming from the O.B. vans whether by cable or radio link. The vision mixing desk and monitor are on the right with the sound mixing desk on the left and the production manager's desk in the centre.

The provision of a central control room was also important, and was analogous to the dramatic control panel of sound broadcasting. It enabled one studio to be faded

the installation of O.B. gear, and several methods of linking it with Alexandra Palace were available—USW radio, balanced cable, and balanced cable plus

Television Progress—

Post Office telephone line. It was possible to use 1 to 4 miles of ordinary telephone line with a repeater every mile.

Referring to the range of Alexandra Palace, Mr. Macnamara said that it had been expected to be about 25 miles, but it had turned out to have a safe range of nearer 35 miles. Good reception had been obtained up to 70 miles. The range was limited by car-ignition interference. It could be said that if all cars were fitted

with suppressors the range would be very greatly increased.

bilities of micro-waves in medical practice. They had been tried in Germany for anaesthesia, and were said to have no after-effects. An UHF field applied to the head resulted in unconsciousness which lasted as long as the field was applied.

The Chairman then declared the meeting open for discussion, and Mr. Davis expressed his conviction that the British television system was sound. The adoption of 405 lines was originally a bold decision which had been justified by

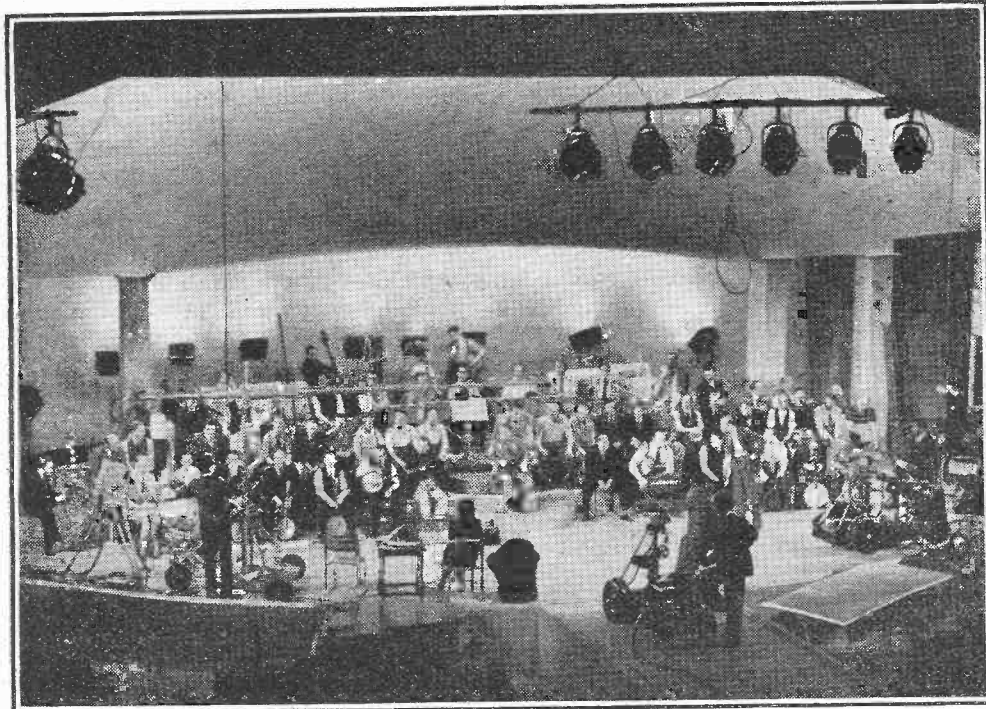

Echo of Olympia. The scene during a rehearsal in the theatre at Radiolympia which was the first to be built for the triple purposes of radio, television and an audience. The output from this went to the special transmitter in the miniature Alexandra Palace whence it was fed to the stands on the normal sound and vision frequencies and to A.P. for retransmission to home viewers.

with suppressors the range would be very greatly increased.

Ultra-High Frequencies

Mr. Owen Harries dealt with the possibility of using wavelengths below two metres. He stressed the need for new research on such wavelengths, both on their production and on their propagation. He felt that it would be found that there was no abrupt change of field strength at the horizon, and he did not think that with high power the range would prove unduly limited. The difficulty was to generate high power, and up to the present only a few watts had been produced.

In America a method had been developed in which a beam of electrons in an applied field had a natural frequency and a negative resistance. The difficulty was that the wavelength depended on the voltage and current, and no one had yet shown a way of amplifying or modulating with such systems.

It was practicable to transmit very short waves down a metal tube with conductive walls, and by placing a horn at the end, reflections could be avoided. The system was reminiscent of a speaking tube and was highly directional.

Mr. Harries also referred to the possi-

events, and he did not think a change would be necessary for years to come. In the case of cinema television a greater number of lines would be desirable because of the direct comparison with films.

He was glad to see a movement away from the use of very small CR tubes, and he pleaded for greater standardisation of installation methods.

Mr. Lance expressed the view that more elaborate aerials and new circuits for ignition interference suppression would be the next developments. Dipoles had been used for years, but he hoped that something better might be found.

Mr. Barton-Chapple asked if it were possible to screen micro-waves adequately so that they would not prove dangerous to the engineers, and he also referred to the possibility of using vertically and horizontally polarised waves of the same frequency without mutual interference.

In reply Messrs. Clark, Macnamara, and Harries agreed that the screening of micro-waves was difficult. They did not feel that it would be possible to avoid interference between stations on the same wavelength by using vertical polarisation for one and horizontal for the other on account of the tilting of the wavefront. Tilts of 20 degrees had been measured on the Alexandra Palace signals.

**Above Three
Megacycles****CONDITIONS ON THE
SHORT-WAVE BAND**

THOUGH these notes are more closely concerned with the technicalities of short-wave propagation and reception than with the programme side, I cannot refrain from mentioning several broadcasts I have heard, and particularly one that stands out above all others of the many put over by the American networks during the few days prior to the fateful Sunday of September 3rd. The broadcast was that carried out by C.B.S. via W2XE on 17 Mc/s describing the evacuation of London school children from Waterloo. The outside broadcast director of the B.B.C., Mr. Joly de Lotbinière, was the commentator, and some interviews were provided by the children, who came from one of the poorest parts of London, and one of their teachers.

There is no doubt that the Columbia Broadcasting System has given its listeners a remarkably complete coverage of European events during the past weeks. Not everybody will agree with the comments made by the C.E.S. news analyst, Elmer Davis, but the C.B.S. commentator in Berlin has done a good job of work. The standpoint of Columbia's European director, Mr. Morrow, has been scrupulously correct throughout this historic period.

Interference from Tokyo

To return to technicalities, some interference with WNBI on 17.78 Mc/s from Tokyo, working on 17.785 Mc/s, has been noticed on some evenings from 10.30 p.m. onwards, GSG, Daventry, on 17.79 Mc/s, in general does not suffer at the moment since Tokyo JZL does not operate at times when a 17-Mc/s frequency is valuable for transmissions from this country.

On Sunday, September 3rd, both W2XE—WNBI and WGEA came on the air some time before their normal opening time and rebroadcast the Prime Minister's speech. Many other special broadcasts were also carried out by these stations during the day, including the King's Broadcast and a talk from London by Cardinal Hinsley.

On Monday, September 4th, W2XE, on 17 Mc/s, did not really become a strong signal until noon, about one hour later than on Sunday, but as on all the other days covered by this report conditions have nevertheless been very good down to 13 metres, though no 11-metre signals have been heard.

President Roosevelt's first neutrality proclamation was heard hot from the White House via W2XE again at 10.30 p.m. Tuesday, September 5th.

On September 6th conditions began to deteriorate a little, but at 10.30 p.m. Buenos Aires—LSL, 21.16 Mc/s—was still strong on 'phone to London on about 14 metres.

At the time of writing there is a distinct tendency toward conditions favouring the higher broadcast frequencies, and by the time that these words are in print I expect that "very short wave" conditions will be prevailing. The 13-metre band will again come into its own.

So ends a memorable week's listening.

"ETHACOMBER."

NEWS OF THE WEEK

MINISTRY OF INFORMATION

Wireless Personalities

IT was announced by Sir Samuel Hoare, Lord Privy Seal, last Thursday, that the newly formed Ministry of Information was, with the exception of a few posts, now fully staffed.

It is organised in 14 divisions, gathered into four groups, the first dealing with news and Press relations and the censorship; the second with the application of publicity on a geographical basis, covering home, the Empire, U.S.A. and other foreign countries respectively; the third with the production of publicity in the form of films, wireless, literature and art, posters, advertisements, periodicals and pamphlets, etc., respectively; and the fourth with administration and co-ordination.

The Minister of Information, Lord Macmillan, is assisted by an Advisory Council, consisting of representatives of the several political parties, of the newspaper world and broadcasting, of business, of the Trades Union Congress and the Co-operative movement, and other general or particular interests.

Among those who have accepted the invitation to sit on the Advisory Council are Mr. F. W. Ogilvie and Lord Iliffe.

Mr. J. H. Brebner, who has for a number of years so successfully filled the post of Controller of Press Information and Publications at the G.P.O., has been appointed assistant director of the News and Press Relations Division which comes under Group I.

The director of the Radio and Communications Division, which comes under Group III, has not yet been appointed. The post of deputy director has been filled by Mr. H. G. G. Welch, who was assistant secretary in charge of the overseas branch of the G.P.O. Telecommunications Dept.

POPULARITY OF PORTABLES

LIKE many of their subjects, The King and Queen have purchased additional receivers for their personal use and that of the royal household. An unprecedented demand for battery and the small mains-driven receivers is recorded by *The Wireless and Electrical Trader* which states, "All-dry portables in particular have established themselves overnight, and there is no doubt that these sets have now come to stay."

WAR NEWS

American Commentaries

MR. F. W. OGILVIE, Director-General of the B.B.C., in his broadcast to the United States last week, referred to the changes in British broadcasting since the outbreak of war.

After reference had been made to the fact that the B.B.C. was now transmitting on the short waves for nearly 22 hours out of the 24, Mr. Ogilvie said: "No doubt you are asking yourselves whether any restrictions have been placed upon the freedom of those who speak to you by radio from England. I can give you the answer.

"There has to be, and there is, a bar against the disclosure by anyone—British, American, no matter whom—of military information which might be of value to the enemy. This applies not only to the radio, but to the Press and other forms of communication. Apart from that, those who speak to you from England enjoy the freedom of expression which they enjoy in peace time. And, not less important, no one makes suggestions to your speakers as to what they ought to say."

The U.S. President has announced that he is not at present considering the imposition of a news censorship in the States. The dissemination of news by wireless is considered to present a problem, especially when transmitted by short-wave broadcasting and amateur stations. It is pointed out by the Secretary to the President, Mr. Stephen Early, that these transmissions might prove to be a

source of aid and comfort to belligerent powers and the establishment of some form of control might become essential.

This move is very probable, for at the moment listeners to the American international short-wave stations are certainly getting first-hand information of the situation in Europe. In fact, news of some happenings are heard from America before it is published in this Country.

C.B.S. and N.B.C. Schedules

The Columbia Broadcasting System, from its station W2XE, is giving three-point (London—Paris—Berlin) commentaries twice each day. The times of these bulletins (G.M.T.) and the frequencies on which they are broadcast are:—

Weekdays:—12.12.15 p.m. 17.83 Mc/s
10.30-10.45 p.m. 15.27 Mc/s
Sundays:—1-1.15 p.m. 17.83 Mc/s
10-10.30 p.m. 15.27 Mc/s

In addition to these three-point commentaries, two news bulletins from London are broadcast on Sundays. These are given from:—

2.45-3 a.m. on 11.83 Mc/s,
and 5.30-5.45 p.m. on 17.83 Mc/s.

The regular English news bulletins from WNBI (ex W3XL), the international short-wave station of the National Broadcasting Company, are radiated daily at 4 and 5 p.m. (G.M.T.) on 17.78 Mc/s beamed to Europe. These bulletins are being supplemented as the need arises and the time of the next bulletin is announced at the close of each.

AMATEUR STATIONS

Transmitters Confiscated

WITHIN a few hours of the announcement by the P.M.G. that all experimental transmitting licences had been withdrawn, Post Office engineers were calling at the addresses of licence holders to remove the apparatus.

In the case of three G3 or G4 stations brought to our notice, which have been licensed for a year or less, the P.O. has taken all transmitting equipment. In one case they carried out a search for spare components.

The engineers made no attempt at complete confiscation in the case of three larger and longer established amateur stations about which we have enquired. In these cases they have removed "token components" such as a crystal and rectifying valve, and relied on the good faith of the operator not to go on the air.

A receipt was given in each case for the apparatus which it is understood was removed to a safe place of storage.

VESSELS IN HARBOUR

Transmitters to be Sealed

THE Postmaster-General gave notice last week that it had been considered expedient that the Government should have control over the transmission of messages by wireless telegraphy, and that the use of wireless telegraphy on board foreign ships while in territorial waters of Great Britain and Northern Ireland will be subject to rules made by the Admiralty.

On entering any port or harbour the WT office will be sealed by the customs officer boarding the vessel. Foreign vessels within territorial waters are to restrict the use of their apparatus as much as possible to avoid interference with essential communications.

THE BRITISH ASSOCIATION

Electron Optics and Television

DR. V. K. ZWORYKIN, the American inventor of the Iconoscope, addressed the Mathematical and Physical Sciences Section of the British Association during the recent meeting at Dundee. He spoke on the recent advances in electron optics and television. The president of the Section, Mr. Robert S. Whipple, director of the Cambridge Scientific Instrument Company, in his presidential address, dealt with the sub-



N.B.C. LISTENING POST. News bulletins from London, Paris, Berlin and other centres of war activity are tuned in by these N.B.C. engineers in the news room. Some are re-broadcast and others are used in the news summaries which are now so popular with listeners in Europe.

News of the Week—

ject of instruments in science and industry.

In order to give a television demonstration, Mr. A. B. Howe, of the B.B.C., used a transmitter and receiver. He explained that as Dundee was so far from London, he could not, of course, produce the high-definition pictures which were provided in the Alexandra Palace service, although the results with the demonstration apparatus were at least comparable. Mr. Howe, with the aid of lantern slides, described the three methods employed for linking the O.B. units with Alexandra Palace, i.e., short-wave radio, balanced cable and combined balance cable and telephone line.

**B.B.C. FOREIGN NEWS
BULLETINS****Daily Broadcasts in Eleven Tongues**

WITH the inauguration last Thursday evening of news bulletins in Polish, the B.B.C. is now using nine foreign languages daily in its short-wave service for overseas reception.

The nine languages, in effect, mean working in eleven different tongues as the idiom and accent used in Spanish for Spain, and Portuguese for Portugal, are very different from those required for the Spanish and Portuguese broadcasts for Latin America.

The languages in which news bulletins are now broadcast daily are:—Afrikaans, Arabic, French, German, Italian, Magyar, Polish, Portuguese and Spanish.

The daily Afrikaans service commenced last Sunday week and the bulletins in Magyar for Hungary on September 5th.

THE POLYTECHNIC

THE radio and television engineering courses at the Polytechnic for the session 1939-40, which commences on September 25th, have been arranged to give students a thorough training in the principles and technique of high-frequency engineering. The courses, which extend over a period of five years, include:—electrical technology, alternating current circuit, radio engineering, alternating current measurements, design of radio apparatus, wave propagation and reception and electro-acoustics.

A two-year course on servicing has been arranged in co-operation with the Gramophone Company and E.M.I. Service. Enrolment begins on September 18th at 307-311, Regent Street, London, W.1, where further details can be obtained.



THE ELECTRONIC ORCHESTRA. All the instruments in the string section of this orchestra, which is regularly heard over the N.B.C. red network, are without soundboards. The vibrations of the strings are conveyed to the loudspeakers in each music stand after passing through the control panel which is operated by the conductor.

DEDICATED TO ENLIGHTENMENT**American Non-commercial S-W Station**

THE short-wave broadcasting station of the World Wide Broadcasting Foundation, of Boston, Massachusetts, U.S.A., has, like all international S-W stations in the States, had its call sign changed. Instead of W1XAL it is now WSLR.

This station, which has a power of 20 kW, broadcasts on three frequencies—6.04, 11.79 and 15.13 Mc/s. The European and Latin American coverage of the station is being enlarged by the erection of diamond aerials within a few hundred yards of the shore of the Atlantic Ocean. These will also be used by WSLR's associate transmitter, which, when it is brought into use later this month, will also have a new call sign. Dedicated to enlightenment, the station is operated for peace rather than for profit.

It is understood that the

autumn programmes, which are now being arranged, will include a special course on radio and television. Details of the World Wide Broadcasting Foundation can be obtained from Station WSLR, University Club, Boston, Mass., U.S.A.

PHOTOTELEGRAPHY

IT has been decided to stop the transmission of photos by wireless. This decision was announced by the Ministry of Information last week.

Ordinary Press photographs may at present be sent by cable and are to be previously censored by the censorship division of the Ministry of Information, to which they will be referred if necessary by the Post Office and cable companies concerned. Only untouched-up photographs are permitted.

RECEIVERS CONFISCATED

IT was announced last week that a decree had been promulgated by the German Government empowering the confiscation of all sets capable of receiving foreign stations. The "People's Set," of course, was not included in this order.

It will be remembered that when discussing the receiver in *The Wireless World* some months ago, it was stated that this detector-LF set is inherently unselective, but with dexterous handling of the controls—especially reaction—it is possible to receive foreign stations provided one is not too close to the local transmitter.

EMERGENCY ADDRESSES

MANY radio manufacturers and associations have moved their offices to places of safety in the country. Below are some of the emergency addresses to which correspondence should be addressed.

- British Insulated Cables, Ltd., Fairmile House, Cobham, Surrey. (Tel.: Cobham 2893.)
- Gramophone Co., Ltd., Blyth Road, Middlesex. (Tel.: Southall 2468.)
- Marconi-Elco Instruments, Ltd., Knoll Cottage, Gills Hill, Radlett, Herts. (Tel.: Radlett 6521.)
- Philips Lamps, Ltd., Clevedon, Cleve Road, Goring, Reading. (Tel.: Reading 288.)
- Radio Manufacturers' Association, 11, Riverdale Gardens, Twickenham, Middlesex. (Tel.: Popesgrove 1741.)
- British Radio Valve Manufacturers' Association, 65, Egmont Road, Sutton, Surrey. (Tel.: Vigilant 2342.)

**FROM ALL
QUARTERS****Standard Frequency Transmissions**

THE National Physical Laboratory has announced that, until further notice the transmission of all standard frequency signals from the N.P.L. station G5HW is suspended.

Bristol Radio Exhibition

LIKE many other functions, the Bristol Radio Exhibition, which was to have been held at the Coliseum from September 6th to 16th, has been cancelled.

No Change

THE appointment of the War Cabinet did not bring about any change in the office of Postmaster-General, which is retained by Major G. C. Tryon, and Assistant P.M.G., which is held by Mr. William Habane, who was appointed in May to succeed Sir Walter Womersley, who is now Minister of Pensions.

I.M.E.

THE INSTITUTION OF MECHANICAL ENGINEERS is carrying on the bulk of its work at a temporary address in the country—The Meadows, Betchworth, Surrey (telephone: Betchworth 63)—but the Institution building in Storey's Gate will remain open, possibly during restricted hours, for dealing with personal inquiries and for members or others wishing to make use of the library.

The Television Society

THE present state of affairs has necessarily led to the temporary suspension of lecture arrangements and other activities of The Television Society. The Society's library is remaining open in the daytime and also in the evening after the necessary A.R.P. alterations have been carried out.

Director of Indian Broadcasting

MR. LIONEL FIELDEN, the director of All-India Radio, is returning to England on medical advice. Mr. Bakhari, the assistant director, is in command whilst Mr. Fielden is away.

News in India

THE scheme for the centralisation of the news bulletins broadcast by the stations of All-India Radio is expected to be completed by next April. News broadcast from Delhi will then be relayed by all A.I.R. stations.

Red Cross and St. John Joint Appeal

IN the grave issues which now confront the British Empire, the British Red Cross Society, of which H.M. The Queen is President, and the Order of St. John, of which H.R.H. the Duke of Gloucester is Grand Prior, have decided to work together as they did in the Great War with results which are still within the memory of the public. With this object a joint emergency committee has been set up, comprising an equal number of members of each body. Considerable voluntary help has already been secured, but it remains to find the money necessary to pursue the work, and a special appeal has been launched by the Duke of Gloucester.

Interference from Electric Razors

ITS NATURE AND CURE

By J. E. M. COOMBES, B.Sc. (Eng.)

THE cutting heads of electric razors which give rise to radio interference are driven by either a commutator, or interrupter motor. The interrupter motor is probably sufficiently unusual to merit a description of its essential features.

Referring to Fig. 1, AB is a dumb-bell shaped soft iron armature placed between the two poles of a horseshoe electro-magnet. The electro-magnet is energised from the mains by two magnet coils in series through a pair of contact points P, which are made to open and close by means of a cam on the armature shaft. When the axis of the armature lies along the dotted line X—X the contact points P close, and the magnet is energised by the current which flows through the magnet

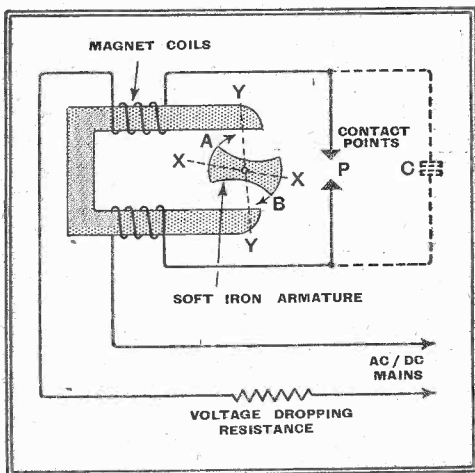

Fig. 1.—Interrupter type of motor frequently used to drive electric razors. It causes intense interference to radio reception.

coils. Since the armature is composed of soft iron, the ends of the armature are attracted to the poles of the magnet to which they are nearest, irrespective of the polarity of the magnet, and if the force of attraction is sufficient the armature turns in a clockwise direction shown by the two curved arrows.

Continuous Rotation

When the armature reaches the position indicated by the dotted line Y—Y the contacts P open, and the torque tending to rotate the armature disappears, since the magnet is now de-energised. However, in rotating from position X—X to position Y—Y the armature acquires sufficient momentum to continue its rotation until it again coincides with X—X and the contacts P close again, the armature receives a further impulse, and the cycle of operations is repeated indefinitely so long as the mains supply is left switched on.

Each time the contacts open they have to break the full current passing through the coils, and as the inductance of the coils tends to maintain the flow of current after the contacts have opened, intense sparking takes place at the points until the current finally reaches zero. To reduce this sparking, and the burning away of the points which it causes, a small condenser C is usually fitted across the contacts.

With the commutator type of motor, on the other hand, only slight sparking occurs if the commutator and brushes are in good condition and properly adjusted.

In general, therefore, it was expected that the interference produced by interrupter motors would be more intense than that produced by commutator motors.

Preliminary tests with electric dry shavers employing both types of motor confirmed this view, and showed that the interference from interrupter-driven shavers—which, unfortunately, are the most common—is particularly virulent and obnoxious, and often completely drowns even very strong stations. The interference from shavers driven with commutator motors is less serious, but still warrants suppression.

The preliminary tests also revealed that the interference radiated directly on the medium and long wavebands is small, and becomes negligible a few yards away from the shaver. The major part of the interference experienced is undoubtedly mains borne, and gains access to the set by re-radiation from the house wiring on to the aerial of the receiving set. With mains-operated sets the interference may also enter by way of the mains transformer.

Before describing the tests in detail it should be mentioned that they were carried out in accordance with the regulations of the British Standards

Institution.^{1 2} These are not generally considered to be over-exacting, and specify that the magnitude of the symmetrical and asymmetrical components of the interference-producing voltages under measurement must not exceed 500 microvolts at any wavelength between 200 metres

and 1,500 metres. By the *symmetrical component* is meant the radio-frequency interference voltage which appears directly across the terminals of the appliance, and by the *asymmetrical component* the voltage which appears between earth and the two mains in parallel.

Curves A and B in Fig. 2 show

symmetrical components of interference produced by interrupter and commutator type razors respectively, the interference being measured in both cases at the terminals of the mains plug supplying the razors. It will be seen that, while the maximum interference from the commutator type of razor does not exceed 1,000 microvolts over the waverange 200 to 2,000 metres, that from the interrupter type of razor reaches a value of no less than 30,000 microvolts over the same waverange.

¹ Limits of Radio Interference, B.S.S. No. 800-1939.

² The Characteristics and Performance of Apparatus for the Measurement of Radio Interference, B.S.S. No. 727-1937.

LETTERS in our correspondence columns have emphasised the severe interference to radio reception which is being caused by the increasing use and popularity of electric razors. The present article describes experiments made to determine the extent and nature of the interference produced, and the relative effectiveness (on the normal broadcasting wavebands) of the various methods of suppression.

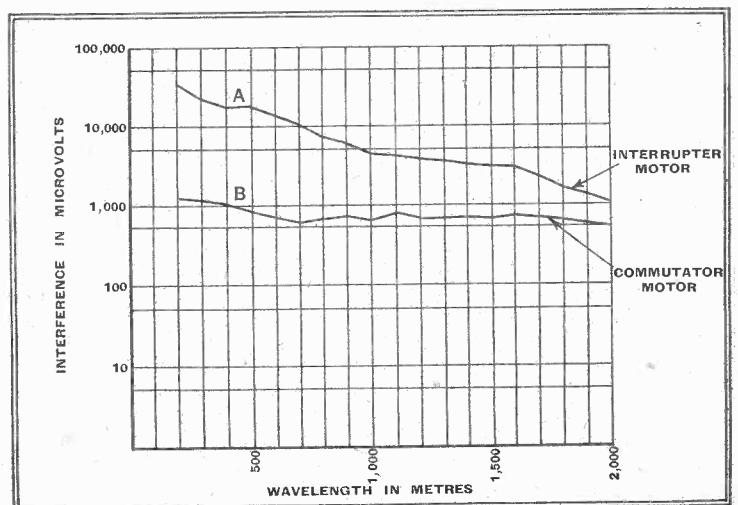

Fig. 2.—Typical symmetrical components of radio interference voltage over the medium and long broadcast wavebands produced by razors fitted with interrupter and commutator motors.

Interference from Electric Razors—

Fig. 3 shows corresponding curves for the asymmetrical components of interference produced. The interference is well below 500 microvolts in both cases, and is probably to be explained by the very low capacity to earth of the frames of the motors.

The interference experienced from interrupter type razors appears to depend upon a number of variable factors. Among these may be mentioned the type of mains used, i.e., AC or DC, the instant and rate at which the contact points open, the length of time during which they remain open, and if the points are at all pitted or burnt away.

Ineffective Shunt Condensers

Experiments with and without various values of condensers connected across the contact points show that while connection of the condenser results in a reduction of the visible sparking it brings about little change in the radio interference produced. Moreover, under certain conditions, it actually causes a considerable increase in the interference, as will be shown later.

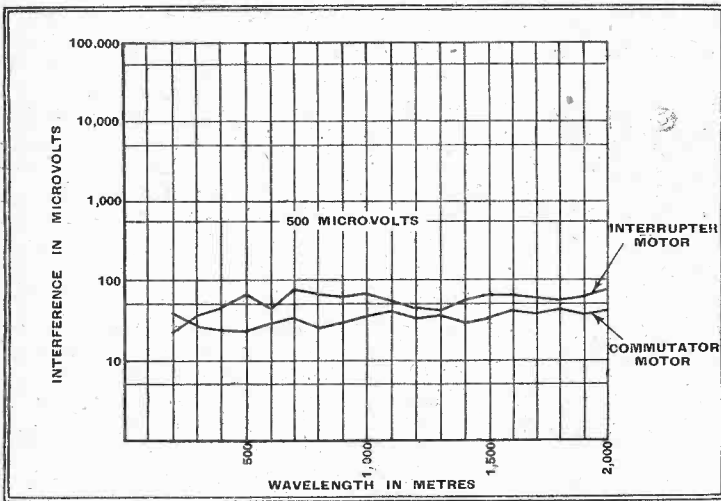

Fig. 3.—Typical asymmetrical components of interference voltage from interrupter and commutator motor razors.

Fig. 4 shows the effect upon the symmetrical component of the interference by fitting various values of condensers across the mains at the supply plug to the razor. As will be seen, a useful degree of suppression is obtained, which increases as the value of condenser is increased. It is also interesting to notice that the degree of suppression with any one value of condenser increases as the wavelength decreases. This, of course, is to be expected, since the reactance of a condenser decreases with increasing frequency. However, no measurable increase of suppression is obtained on raising the value of the condenser above 0.5 mfd., and as the general level of interference is then still about 1,000 microvolts, this method of suppression by itself is clearly insufficient.

Tests were next made with choke coils connected in series with each of the mains leads at the power plug supplying the razor. It was considered reasonable to

expect that the use of choke coils of suitable inductance and self-capacity would result in a fair degree of suppression over the whole of the medium and long wavebands. Actual experiment, however, showed that this was far from being the case, and that the interference was actually increased at certain wavelengths with the choke coils connected.

Curve A of Fig. 5 shows the symmetrical component of interference obtained from the razor without suppression and with the condenser normally fitted across the contact points disconnected. Curve B shows the interference obtained with the addition of 800-microhenry choke

not at first obvious, but on investigation it was found to be caused by resonance between the choke coils and the capacity which exists between the moulded rubber flexible leads which connect the razor to the power plug. Referring to Fig. 6, Z_1 represents the RF impedance of the razor, and V_1 the radio frequency voltage which appears across Z_1 . The flexible leads between the razor and the power plug are represented by ab and cd , and the capacity between them by the con-

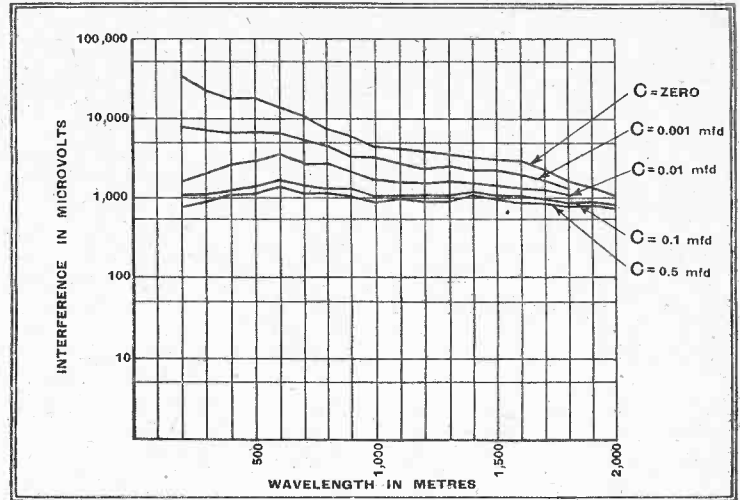

Fig. 4.—Symmetrical interference from interrupter type razor with various condensers connected across the mains at the power plug supplying the razor.

denser C. L_1 and L_2 represent the choke coils in series with each mains lead, and Z_2 is the radio frequency input impedance presented by the mains. It will be seen that the capacity C is in parallel with the inductances L_1 and L_2 and the mains impedance Z_2 , and they therefore form a parallel resonant circuit. At resonance the current circulating in the two branches of the circuit will be limited only by the total resistance, and may be many times the current in the leads ab and cd . The voltage V_2 which appears across the mains impedance Z_2 as a result of this current will thus be very large, and may exceed the applied voltage V_1 . A distinct maximum of interference occurs at 900 metres, and the RF voltage generated is then some 26,000 microvolts greater than at the same wavelength with the choke coils disconnected.

The reason for this behaviour was not at first obvious, but on investigation it was found to be caused by resonance between the choke coils and the capacity which exists between the moulded rubber flexible leads which connect the razor to the power plug. Referring to Fig. 6, Z_1 represents the RF impedance of the razor, and V_1 the radio frequency voltage which appears across Z_1 . The flexible leads between the razor and the power plug are represented by ab and cd , and the capacity between them by the con-

denser C. L_1 and L_2 represent the choke coils in series with each mains lead, and Z_2 is the radio frequency input impedance presented by the mains. It will be seen that the capacity C is in parallel with the inductances L_1 and L_2 and the mains impedance Z_2 , and they therefore form a parallel resonant circuit. At resonance the current circulating in the two branches of the circuit will be limited only by the total resistance, and may be many times the current in the leads ab and cd . The voltage V_2 which appears across the mains impedance Z_2 as a result of this current will thus be very large, and may exceed the applied voltage V_1 .

Altering Resonant Wavelength

If the value of C is increased by connecting fixed condensers in parallel with the flexible leads at points b and d in Fig. 6, the wavelength at which resonance occurs increases, and the peaks of inter-

Fig. 5.—Symmetrical interference from interrupter type razor, showing resonance effects obtained with 800-microhenry choke coils in each mains lead at the power plug and various condensers in parallel with the flexible cable to the razor. Condenser capacities: Curve B, nil; C, 0.0004 mfd.; D, 0.005 mfd.; E, 0.01; F, 0.1 mfd.

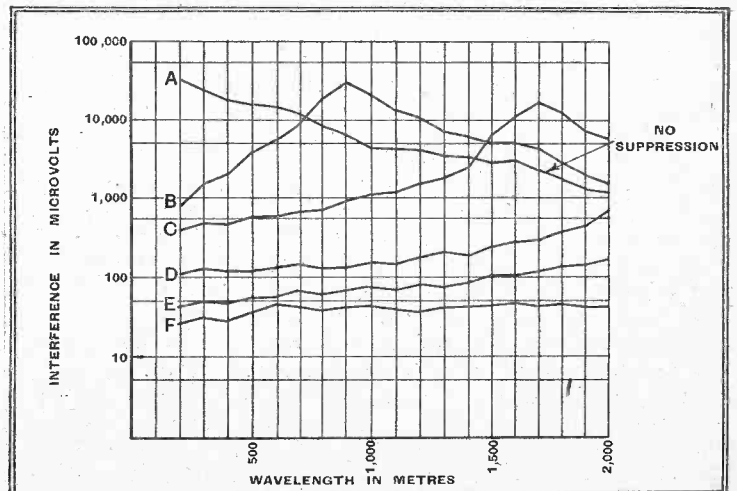

Interference from Electric Razors—

ference move to the right-hand side of Fig. 5. (Compare curves B and C.) With larger values of capacity the resonant wavelength occurs above 2,000 metres, and the effect of resonance upon the interference obtained reveals itself only by a gradual increase in the interference level as the wavelength is increased up to 2,000 metres (curves D and E). Moreover, as the choke coils become increasingly effective, the general level of interference falls, and the degree of suppression obtained between 200 and 2,000 metres increases. With a condenser value of 0.1 mfd. the curve becomes sensibly horizontal, and at no point does the interference exceed 50 microvolts. This degree of suppression is very good indeed, and should be adequate in the most exacting circumstances. On a sensitive receiver using an indoor aerial in the same room as the razor no trace of interference could be detected anywhere on the medium and long broadcast wavebands.

A useful feature of the arrangement is

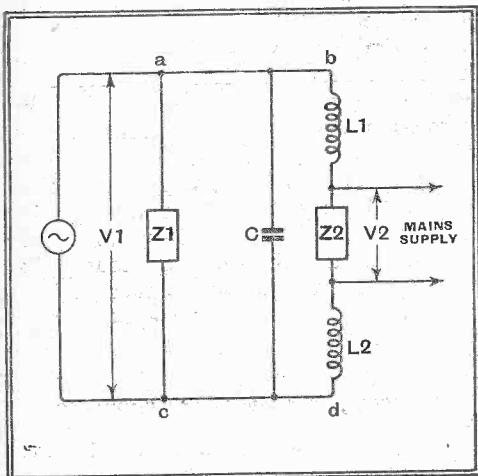

Fig. 6.—Equivalent diagram for radio frequencies with 800 microhenry choke coils connected in series with each mains lead at the power plug.

that it can be used with any make of interrupter type razor with equally good results, for changes in the capacity of the flexible leads or motor will be negligible compared with a condenser value of 0.1 microfarads. For the benefit of readers who may wish to try out a filter on these lines instructions for winding the choke coils are given at the end of this article.

From the preceding discussion it is now possible to explain why, as mentioned earlier on, the fitting of a condenser across the contact points of an interrupter type of motor often causes an increase in the radio interference experienced, despite the fact that it reduces the visible sparking which occurs.

Referring to Fig. 1, it will be realised that the condenser C is in parallel with the magnet coils and the RF impedance of the mains in precisely the same way as the capacity of the flexible leads and choke coils described above. Thus, if the resonant wavelength occurs in, or near to, the normal broadcast wavebands a considerable increase in the interference experienced may occur.

PLEASE ORDER NOW

Readers are earnestly requested to instruct their local newsagents to reserve a copy of this journal for them regularly.

This is in order to facilitate distribution arrangements and avoid the risk of failure to obtain copies.

In the interests of the paper itself in these difficult times it is particularly hoped that regular purchase be made from the same newsagent or bookstall each week.

Please see the emergency order form printed in our advertising pages.

The usual value of condenser fitted across the contact points is about 0.0003 microfarads, and as it is not desirable to omit the condenser completely, the obvious course is to fit a condenser of 0.01 to 0.1 microfarads and so raise the resonant wavelength well above 2,000 metres. Unfortunately, this usually results in the motor slowing down, and either the motor must be designed to give a resonant wavelength well outside the broadcast wavebands with the usual value of condenser, or it must provide sufficient torque to maintain the speed with a larger value of condenser. In both cases the problem is one for the manufacturers, and in the meantime the filter described above should give an adequate degree of suppression with all existing models of interrupter type razors.

Due to the smaller level of interference produced by the commutator motor type of razor it was found that adequate suppression can usually be obtained by connecting a condenser of about 0.1 microfarads across

the mains at the power plug, or preferably, directly across the brushes themselves if room can be found for the condenser inside the case of the razor. As the interference produced depends very much upon the condition of the brushes and commutator they must be inspected periodically and always kept perfectly clean. Also the interference experienced varies considerably with different samples of the same model of razor, so that it may not always prove possible to suppress the interference sufficiently in this way. In such cases the filter described above for use with interrupter type razors may be used, and should always prove satisfactory.

APPENDIX.

Details of 800-microhenry choke coils:—

Diameter of former	1.5 inches
Length of former	2.5 inches
Wire (enamelled)	32 S.W.G.
Number of turns	200
Approximate winding length	2 inches
D.C. resistance	6.9 ohms

Henry Farrad's

PROBLEM CORNER

No. 37.—Disappointment With Negative Feedback

An extract from Henry Farrad's correspondence, published to give readers an opportunity of testing their own powers of deduction:—

Howell House,
Keston.

Dear Henry,

I have not been quite satisfied with the quality of reproduction from my receiver, and cannot, at the moment, afford a new one. But I have read a good deal about the merits of negative feedback in this respect, especially where pentodes are concerned. To my joy I learned that it was possible to introduce negative feed-

Why were results disappointing when negative feedback was applied to this circuit?

back without spending anything on extra components; in fact, one is removed, namely, the condenser shown dotted in the enclosed circuit diagram of the output end of the set. My joy lasted only until I tried it, for quality is worse instead of better! I was afraid the idea was too good to be true.

If negative feedback really can improve pentode quality, will you tell me what is wrong?

Yours sincerely,
Philip Cowe.

Henry Farrad's suggestions are on page 263.

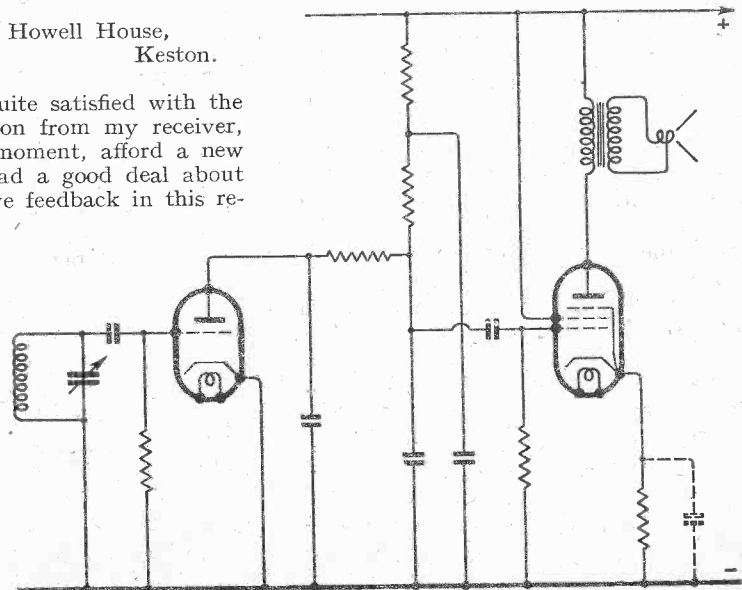

Random Radiations

By "DIALLIST"

Battery Hoarding

ONE would have thought that those who indulged in panic buying of wireless and other dry batteries during the crisis of a year ago would have developed the proverbial double shyness of the once bitten. If you remember, some of them bought HTB's by the dozen with the idea of being assured of a supply for two or three years to come. Such folk had eventually to get rid of them at a heavy loss or to cast them into dustbins, useless but unused. The guaranteed shelf life of most radio HTB's is, I believe, but three months, though good ones will be in excellent order after a very much longer time than that. Still, no dry HTB lasts for ever, even if it isn't used. Well, much the same kind of battery hoarding apparently occurred at the beginning of this month. My HTB was showing signs of old age on the 3rd, so I went into a largish nearby town for a new one of the standard 120-volt type. To my astonishment I heard that not a single dry battery of any kind—flashlamp or wireless—was left in the shops. I only hope that the one that ought to have come my modest way goes stale on the hoarder who probably bought it as one of a dozen!

The Pity On't

SOME time ago I remember reading in *The Wireless World* an article seeking to show that wireless could be one of the most potent factors in preventing war. It might indeed have been, for before it began to be devoted so largely to the most undesirable kind of propaganda, there were distinct signs that international broadcasting, particularly on the short waves was tending to make the nations understand one another better; and if understanding everything doesn't always mean pardoning everything, it does anyhow go a long way. You cease to regard the other fellow as so complete a foreigner when you can bring his voice and the entertainment that he offers into your own home by a twist of the knob. But for a long while now wireless has not been allowed to make for peace. Stations have been jammed regularly and deliberately. Lying and provocative propaganda broadcasts have poisoned the ether. People in certain countries have been forbidden to listen to stations in other lands. The pity of it! Wireless could have done so much to promote understanding and stability; it has been put to the debased uses of promoting misunderstanding and instability.

A Magician

AT the village inn in which I'm billeted at this moment there is a battery set of good make, only two years old. Seldom have I heard such weird noises as came from it when the landlord switched on to give us the news bulletin on the evening of our arrival. The thing was a superhet and it was tuned just that much off resonance that makes superhets give of their very worst. Agonised, I made a bound for the tuning knob and was about to give it the necessary tweak, when the landlord begged me not to upset the adjustment he had so carefully made; the set, he assured me, was tuned

"just right." He yielded at length to my entreaties. I helped the announcer to get rid of a mouthful of potatoes—not just the usual one—and turned down the volume till the output valve wasn't overloaded, and asked how that would do. Apparently he now regards me as some kind of magician, who has made his wireless set do the impossible. At any rate, he says that he didn't know that wireless could be like that!

Quality!

A LONDON reader sends me an account of a little incident which goes to confirm what I've said more than once in these notes: that many folk are content with vile quality of reproduction from their wireless sets and know not that anything better can be obtained. This reader was recently in a cinema, seated just in front of a mother with a kiddie which showed more than the usual intelligent interest in the feature film, whose sound accompaniment was of a very high order of quality. After this film there was a "fill-in" in the shape of a very poor gramophone record, very poorly reproduced. "Listen, Mummy," said the infant, "that's the wireless." Yes, I know lots of sets that sound like that.

Whilst the Going is Good

IT wouldn't surprise me very much if some of this year's models, as seen at Olympia, are soon at a premium. Many radio manufacturers have been doing a great deal of work for the various Services for a long time now; and in the present circumstances it's likely that they'll be doing much more. If, therefore, you have made up your mind that you need a new set, it would be no bad thing to be after it whilst the going is still good. I don't mean that there is likely to be any kind of famine in wireless sets; it's most improbable that there will be anything of the sort, at any rate so far as the smaller sets are concerned. But prices may rise, and it may take some time to get delivery if you postpone your order too long. In these times you can't afford to be without a wireless set, wherever you live; it keeps you in touch with the news, for which we are all athirst, and supplies entertainment, which is sadly lacking now that theatres, cinemas, and so on, are closed.

No Restriction on Receiving

SOME people thought that one of the first regulations to be made on the outbreak of war would be for the revocation of receiving licences and the confiscation of all wireless sets. I can't think why. The more receivers there are in use the better able are the authorities to keep in touch with the population of the country when they want to make important announcements. The use of these sets is, therefore, sure to be encouraged rather than otherwise. Transmitting sets are, of course, on a different footing; but so many amateur transmitters have joined the Wireless Reserve or are busily employed in other helpful ways that

restrictions on the use of these won't cause great hardship. By the way, those who talked about the calling in of wireless sets can't have given much thought to the problem of storage. You can amuse yourself by working out just how much accommodation would be needed to house, closely packed, the receivers in use in this country!

Ample "Juice"

SOME may be tempted by the cutting down of the amount of current to 75 per cent. of last year's requirements to go in for sets with a small number of valves. Or should I put it that they may hesitate to invest in receivers with a higher loading than those that they have at present? I don't think there's any need to worry. Seventy-five per cent. of last year's kilowatt-hours is quite a generous allowance, for usually it's easy to save 25 per cent. on one's lighting, at any rate without feeling it very much. Anyway, A.R.P. and the lighting regulations will automatically take care of a good deal of it. And most of us use unnecessarily bright lights in the hall, the passages, the bathroom, the landings, and so on. When I went over my lights before leaving for "somewhere in England," I found that I could substitute "seventy-fives" for "hundreds," "sixties" for "seventy-fives," "forties" for "sixties," and so on, in many places without making things too gloomy. And don't forget the ten-watt lamp, which will often give light enough in places where "twenty-fives" are normally used. A little juggling with the lights will most likely leave you an ample reserve for running a receiver with quite a lot of valves.

News from the Clubs

Uxbridge and District Shortwave Club

Headquarters: 61, High Street, Uxbridge, Middx.
Hon. Sec.: Mr. C. J. Bayley, 61, High Street, Uxbridge, Middx.

Shortwave listeners in Uxbridge and district who are interested in the activities of this newly formed society are asked to get in touch with the hon. sec. This club is additional to those given in our Directory of Radio Societies, which was published in our issue dated April 6th.

Edgware Shortwave Society

Headquarters: Constitutional Club, Edgware, Middx.
Meetings: Wednesdays, at 8 p.m.
Hon. Sec.: Mr. F. Bell, 118, Colin Crescent, Hendon, London, N.W.9.

The past month has been devoted to lectures given by members concerning their equipment.

Slough and District Shortwave Club

Headquarters: 35, High Street, Slough, Bucks.
Meetings: Alternate Thursdays at 7.30 p.m.
Hon. Sec.: Mr. K. A. Sly, 16, Buckland Avenue, Slough, Bucks.

At the last meeting Mr. Bayley gave a talk on "Test Equipment." He was followed by Mr. Houchin, who lectured on "The Theory and Construction of a Milliammeter." A successful junk sale was also held. At the next meeting a further talk will be given on test equipment. It has been decided that a discussion on 56 Mc/s should be held at each meeting.

Watford and District Radio and Television Society

Headquarters: Carlton Tea Rooms, 77, Queen's Road, Watford, Herts.
Hon. Sec.: Mr. P. G. Spencer, 11, Nightingale Road, Bushey, Herts.

Mr. N. Salmon lectured on "Radio Activity in Cornwall" at the last meeting. Mr. P. G. Spencer followed with a description of stations he had visited recently in Paris, Zürich and Geneva. The next meeting will be held at 8 p.m. on September 18th.

Recent Inventions

DF BEAMS

WHEN transmitting a pair of radio beams which overlap along a given line, so that a pilot hears a continuous signal so long as he keeps to that line, it is found difficult to avoid the production of secondary lobes or beams, of less strength than the primary beams. These secondary beams extend to the rear of the main beams, but since they also overlap, they, too, produce lines along which signals will be heard. Should a pilot happen to fly into this region, he may be led to think that he is flying along the true course whereas, in fact, he is not.

In order to avoid this danger, the beacon transmitter is made to radiate a circular field, which is of sufficient radius to include any false courses formed by secondary lobes of radiation, though not of sufficient range to obscure the main beams. This circular field produces in the receiving set an AVC voltage which is used to prevent any false signals due to the short-range secondary lobes from being heard.

Marconi's Wireless Telegraph Co., Ltd. and C. S. Cockerell. Application date October 29th, 1937. No. 504744.

CATHODE-RAY STORING DEVICE

THE figure shows a cathode-ray tube which is designed to store an incoming signal before reproducing it. The tube is fitted with two guns G and G1, located at each end, the electron beams so produced being arranged to move over the two opposite faces of a central screen S. The latter

Brief descriptions of the more interesting radio devices and improvements issued as patents will be included in this section.

acts as a storing device for a period which is determined by introducing a phase difference between the timing applied to the two different sets of deflecting plates D and D1 from a common source X.

The incoming signals are applied to the control grid of the gun G and charge up a series of small condenser elements formed of metallic plugs P (see inset diagram) set in an insulating disc B on the screen S. The plugs co-act with an outer metal ring P1, which serves as a common condenser plate. The electron beam is given a circular movement by the voltages supplied to the deflector plates D from the source X.

The beam from the gun G1 collects the signals by discharging each of the small condensers P, P1, in turn, from the opposite face of the screen, the discharge impulses being passed via a load resistance R to an amplifier V. The delay between the recording of the signals by the stream from the gun G, and their collection or reproduction by the gun G1, is controlled by the phase-shift introduced at M in the scanning voltages applied by the source X to the deflector plates D.

Standard Telephones and Cables, Ltd. (assignees of R. R. Riesz and H. S. Wertz). Convention date (U.S.A.), May 29th, 1937. No. 501179.

ELECTRON MULTIPLIERS

AN electron multiplier is fitted with a special form of target electrode which is permeable to the electron stream. It is made of a metallic film, of the order of a millionth of a centimetre in thickness, which is supported on a mesh or grid structure, the spacing of the mesh being sufficiently fine to make a firm foundation for the film.

When electrons impinge on one side of the film, secondary electrons are emitted from the other side, and pass on to a second target electrode, where a similar action takes place. As used in television, an image of the picture is projected on to a photo-sensitive cathode, and the electrons emitted from the latter are passed in succession through a series of these target electrodes until they reach a luminescent screen, where they produce a brighter image than usual owing to the amplifying effect of the secondary emission at each of the intermediate targets.

J. D. McGee. Application dates October 28th and December 7th, 1937. No. 504927.

AVOIDING INTERFERENCE BY DETUNING

WHEN receiving stations which are subject to severe interference, it is possible to mistune the set slightly to one side or other of the carrier wave, and to select

either set of side-bands according to which shows the greater freedom from interference. It is possible for this operation to be controlled by a current which is automatically regulated by the amount of interference present.

The figure shows a variable condenser included for this purpose in the local-oscillator circuit of a superhet. The normal setting of the fixed and moving plates of the

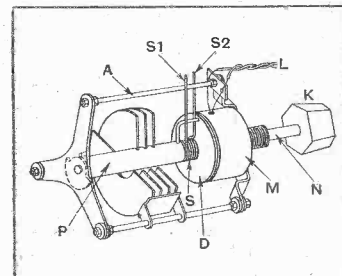

Special condenser for automatic "detuning."

condenser is as shown, and a spiral spring S, with two extensions S1, S2 "straddling" the arm A, tends to restore this position after any deliberate mistuning.

A pot magnet M is energised through leads L by the control current produced by the presence of interfering signals. If the control knob K is then moved to one side or other, the shaft N is "clutched" through a disc D to the shaft P so that the condenser plates are moved to detune the set in the way required. To select a new station, the circuit containing the leads L is automatically opened by operating the main tuning-control knob, thus de-energising the magnet. At the same time the spring S restores the movable plates of the condenser to their normal position.

H. J. Parrish. Application date July 31st, 1937. No. 503133.

SCANNING IMPROVEMENT

TO produce the illusion of movement, it is necessary to make use of the persistence-of-vision effect. But as applied to a cathode-ray television receiver, this leads to a certain loss in the brilliance of the light which can be produced on the fluorescent screen, owing to the short period of activation of each scanning line. There must also be taken into account an inherent "attenuation" in the power of the eye to respond to the persistence-of-vision effect; as a result the apparent brightness of the picture, as perceived by the tired eye, is less than its actual brightness. Finally a considerable amount of artificial flicker is created by the strain imposed on the eye in following the swift succession of changes. The argument, in short, is that if the persistence-of-vision effect could be eliminated, the picture would seem considerably brighter.

According to the invention, a close approximation to this ideal is secured by making the light produced by each scanning line last

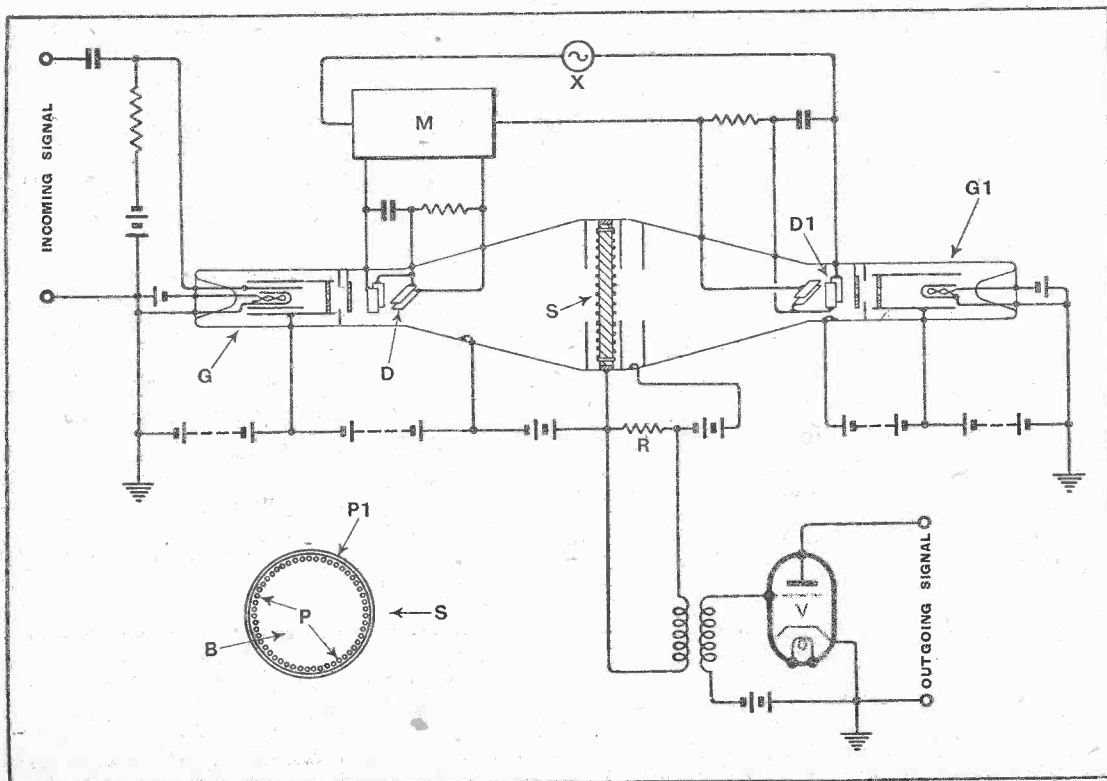

Two-gun CR tube for "delayed" reproduction.

Recent Inventions—

for a longer period than usual, preferably for almost the whole period between one frame and the next. As soon as one scanning line has been completed, it is kept "alive" by means of secondary emission until the time approaches for that scanning line to be repeated, whereupon the production of secondary electrons is automatically stopped so that the screen is ready to receive the next scanning line.

E. P. Rudkin and G. M. Hellings. Application dates July 15th and 31st, 1937. No. 504268.

AUTOMATIC TUNING CONTROL

THE figure shows an arrangement for automatically varying the tuning of a local-oscillator circuit so as to compensate for any slight error in the initial tuning of the set.

The valve V is a triode hexode used as a frequency mixer, the triode part of the valve feeding the local oscillator circuit L. The lat-

circuit of the set, and so prevents any falling-off in selectivity.

E. K. Cole, Ltd., and G. Bradford. Application date, November 9th, 1937. No. 505124.

TELEVISION SYSTEMS

PICTURE to be televised is projected through a lens on to a "permeable" grid or grille covered by a very thin layer of mosaic cells which develop corresponding charges. The screen is independently "sprayed" by a stream of electrons emitted by cathodes which are arranged so as not to interfere with the passage of light from the picture to the screen. The "image" charges previously developed on the screen then allow some of the sprayed electrons to pass through, but stop others. Those that pass through in this way form an electron stream "modulated" by the original picture.

The modulated stream is focused on to a second screen located at the far end of the tube,

it is also difficult to avoid leaving a thin layer of air between the crystal and foil. This tends to produce "bubbles" when voltage is applied, and so causes the foil to break away.

To avoid these difficulties, it is proposed to produce crystal plates of the required size by "growing" them artificially, and under suitable control, from a concentrated solution, and to apply the electrodes by vaporising silver directly on to the crystal surface. This provides a perfectly homogeneous crystal, with a firmly attached electrode, capable of reproducing all sounds within the audible frequency at high intensity and without harmonic distortion.

The British Thomson-Houston Co., Ltd. Convention date (Germany), December 17th, 1937. No. 506154.

HOMING INDICATORS

AN automatic indicator can be given to the pilot of an aeroplane "homing" on to a distant beacon station, to inform him

viates to one side or other, one half of the circular trace remains steady, while the other half "shrinks" by an amount which shows how far the plane has yawed.

Telefunken Ges für drahtlose Telegraphie m.b.h. Convention date (Germany), October 8th, 1937. No. 503471.

AUTOMATIC DIRECTION FINDERS

RELATES to a direction finder of the kind used for "homing" on to a distant transmitting station, the "bearing line" being shown as a continuous trace formed on the fluorescent screen of a cathode-ray tube. In such an arrangement it is usual to combine the pick-up voltage from a frame aerial with that from a vertical or non-directive aerial, alternately in phase and in phase-opposition, so that the resultant response is "heart shaped," and gives both the direction and "sense" of the distant transmitter. This combined voltage is applied to one pair of the deflecting plates of the cathode-ray tube, whilst a "timing" voltage, derived from a local source, is applied to the second pair of deflecting plates.

According to the invention, the combined signal voltage is applied in parallel, and the local timing voltage in push-pull, to a single pair of valves. These serve both to reverse the phase of the aerial voltage (since when one valve conducts, the other is biased to the cut-off point by the local voltage) and at the same time to apply an approximately rectangular timing voltage to the cathode-ray tube.

Telefunken Gesellschaft für drahtlose Telegraphie m.b.h. Convention date (Germany), July 8th, 1937. No. 501251.

AIDS TO NAVIGATION

TO assist a pilot to find a cross-country course (as distinct from "homing") by making use of a single beacon station, he is provided with a transparent template on which a series of curves are drawn. Each represents the loci of points of maximum (or minimum) signal strength, as previously determined during a series of calibration flights.

The template is placed over a map or chart of the district concerned, so that both the beacon station and the point of departure are correctly aligned on the map and on the template. The cross-country route to any destination within the area covered by the template can then be followed if the pilot sets his DF frame aerial to the angle marked on the appropriate curve, and then flies so as to keep the signals received from the beacon station constantly at maximum strength.

Marconi's Wireless Telegraph Co., Ltd.; J. M. Furnival; and B. J. Witt. Application date November 18th, 1937. No. 505913.

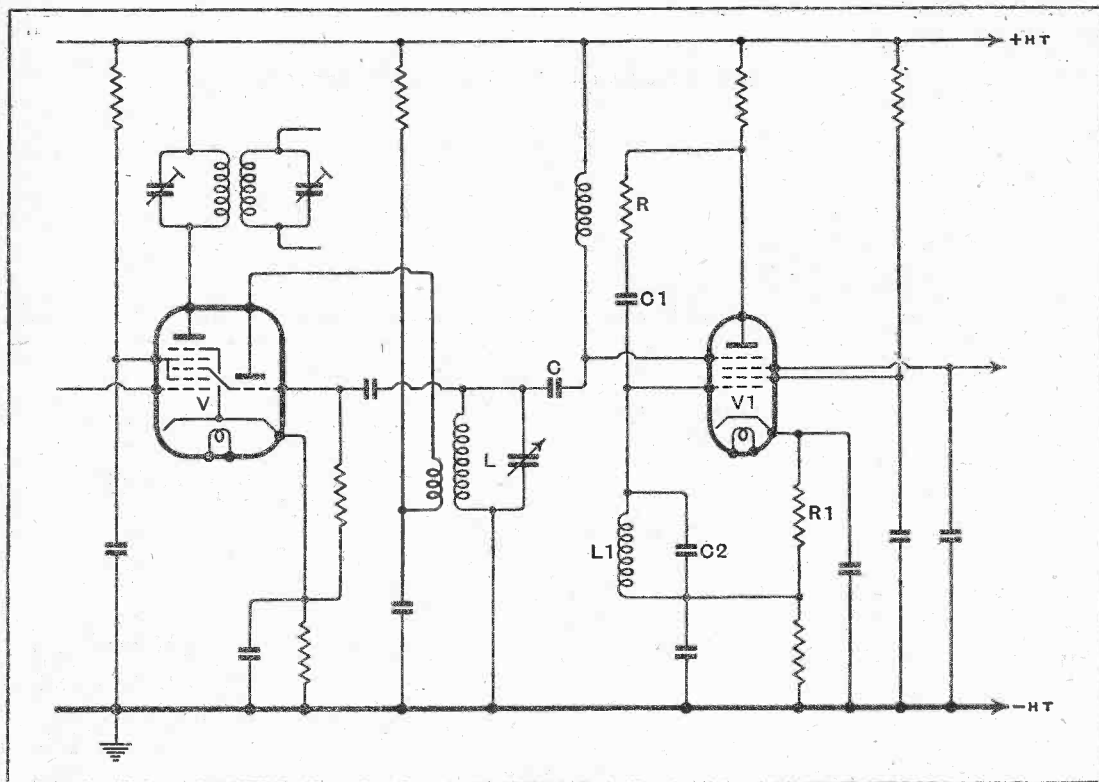

Controlling frequency-changer tuning.

ter circuit is coupled by a condenser C to an auxiliary grid in the control or variable-impedance valve V1, so that the capacity between this grid and the cathode of the valve V1 is in shunt with the circuit L to be controlled.

Between the anode and the cathode of the control valve V1 a potentiometer circuit is included, comprising a resistance R, a condenser C1, an inductance L1 shunted by a condenser C2, and a resistance R1. A tapping from this potentiometer places on the inner grid of the valve V1 a voltage which is out of phase with the anode voltage, and so varies the shunt capacity across the circuit L to the extent required to control its tuning. An advantage of the arrangement is that it has no damping effect on the tuned input

and on its way is intensified by passing through a number of secondary-emitting electrodes. The second screen may be of fluorescent material when the intention is to produce a brighter picture; or it may be a non-sensitive "mosaic" screen, which is swept by a scanning stream of electrons to produce signal currents for transmission.

H. G. Lubyszynski and J. D. McGee. Application date November 10th, 1937. No. 505618.

PIEZO-ELECTRIC CRYSTALS

THE piezo-electric plates used for microphones and loudspeakers are usually cut from a large crystal, to which electrodes are attached in the form of silver foil. The mechanical resistance of such crystals is however low, and

when, and to what degree he is flying off his course. This is usually done by means of a centre-zero meter, which is constantly fed with the combined pick-up voltage from a frame and vertical aerial, so that the needle reads zero only for so long as the machine is heading straight towards the beacon. Unfortunately interfering signals are apt to produce misleading movements of the needle, and it is also difficult to keep it steady if the beacon station is also used for transmitting morse or other signals.

According to the invention, a cathode-ray indicator is used to overcome both difficulties. It is arranged so that a circular trace is formed on the fluorescent screen so long as the machine is on its correct course. If the machine de-

The British abstracts published here are prepared with the permission of the Controller of H.M. Stationery Office, from specifications obtainable at the Patent Office, 25, Southampton Buildings, London, W.C.2, price 1/- each

GOODMANS

LOUDSPEAKERS for A.R.P.

PUBLIC ADDRESS LOUDSPEAKERS

CABINET LOUDSPEAKERS

LOUDSPEAKER UNITS

also

MOVING-COIL MICROPHONES

(Chassis Type)

If particulars of your requirements are sent immediately adequate stocks are still available.

GOODMANS INDUSTRIES, LTD., Lancelot Rd., Wembley, Middx. Phone: WEMbley 4001 (5 lines)



LEARNING MORSE

AN EASY METHOD OF MASTERING THE INTERNATIONAL SIGNAL CODE

Published from the Offices of **The Wireless World** ILIFFE & SONS LTD., Dorset House, Stamford St., London, S.E.1

6^d NET BY POST 7d. W.W.04

Fourth Edition—Revised and Enlarged with Fifty Additional pages.

WIRELESS SERVICING MANUAL

By W. T. COCKING (of "The Wireless World")

The most complete book of reference of its kind. A reliable practical guide for amateur and professional.

It deals fully with Testing Apparatus and explains the methods of locating and curing faults in receiving equipment. Includes a special chapter on Television Receivers. Ganging, Automatic Volume Control, Instability, Distortion, Mains, Hum, Whistles and Local Interference are all separately treated. Much additional information on short-wave receivers, and on methods of operating extension loud speakers is also included.

PRICE 5/- net By post 5/5

Issued in conjunction with "THE WIRELESS WORLD" and Published by the Proprietors: ILIFFE & SONS LTD., DORSET HOUSE, STAMFORD ST., LONDON, S.E.1

W.W.20



SHERLOCK HOLMES says...

"If it's electric test it with a PIFCO"

Don't waste time over testing electrical appliances. The Pifco Rotameter will do it for you, swiftly, surely, and with the minimum of trouble. Whether you're an amateur or an expert, it will enable you to trace faults immediately in radio sets, bells, or anything electrical. It is made from the finest of materials: designed for durability and absolute precision. EIGHT RANGES:

0-5 volts	0-10mA
0-20 volts	0-50mA
0-100 volts	0-250mA
0-400 volts	

Resist/valve test
Plug-in test for valves.
Complete in velvet-lined case with testing leads.
Your regular dealer can supply you, or write:

PIFCO LTD.
Watling St., Manchester.
London Address:
58, City Road, E.C.1.

PIFCO



42/-

PIFCO ALL-IN-ONE A.C./D.C. RADIOMETER

The only instrument of its kind in the world for making both A.C. and D.C. tests.
RANGES: 0-6 volts, 0-240 volts, 0-30 mA.

Filament and Resistance Test, and socket for plug-in test for valves. 8,000 ohms resistance. Complete with two 15-inch flex cables. Fitted with PIFCO DRY CELL.....



12/6

ROTAMETERS and RADIOMETERS
PIFCO ON THE SPOT WILL TRACE YOUR TROUBLES LIKE A SHOT

Mention of "The Wireless World," when writing to advertisers, will ensure prompt attention.

CLASSIFIED ADVERTISEMENTS

NOTICES

THE CHARGE FOR ADVERTISEMENTS in these columns is

12 words or less, 3/- and 3d. for every additional word.

Each paragraph is charged separately and name and address must be counted.

SERIES DISCOUNTS are allowed to Trade Advertisers as follows on orders for consecutive insertions, provided a contract is placed in advance, and in the absence of fresh instructions the entire "copy" is repeated from the previous issue: 13 consecutive insertions 5%, 26 consecutive, 10%; 52 consecutive, 15%.

ADVERTISEMENTS for these columns are accepted up to FIRST POST on MONDAY MORNING (previous to date of issue) at the Head Offices of "The Wireless World," Dorset House, Stamford Street, London, S.E.1, or on SATURDAY MORNING at the Branch Offices, 8-10, Corporation Street, Coventry; Guildhall Buildings, Navigation Street, Birmingham, 2; 260, Deansgate, Manchester, 3; 26a, Renfield Street, Glasgow, C.2.

Advertisements that arrive too late for a particular issue will automatically be inserted in the following issue unless accompanied by instructions to the contrary. All advertisements in this section must be strictly prepaid.

The proprietors retain the right to refuse or withdraw advertisements at their discretion.

Postal Orders and Cheques sent in payment for advertisements should be made payable to LILFFE & SONS Ltd., and crossed & Co. Notes being untraceable if lost in transit should not be sent as remittances.

All letters relating to advertisements should quote the number which is printed at the end of each advertisement and the date of the issue in which it appeared.

The proprietors are not responsible for clerical or printers' errors, although every care is taken to avoid mistakes.

NUMBERED ADDRESSES

For the convenience of private advertisers, letters may be addressed to numbers at "The Wireless World" Office. When this is desired, the sum of 6d. to defray the cost of registration and to cover postage on replies must be added to the advertisement charge, which must include the words Box 000, c/o "The Wireless World." All replies should be addressed to the Box number shown in the advertisement, c/o "The Wireless World," Dorset House, Stamford Street, London, S.E.1. Readers who reply to Box No. advertisements are warned against sending remittances through the post except in registered envelopes: in all such cases the use of the Deposit System is recommended, and the envelope should be clearly marked "Deposit Department."

DEPOSIT SYSTEM

Readers who hesitate to send money to advertisers in these columns may deal in perfect safety by availing themselves of our Deposit System. If the money be deposited with "The Wireless World," both parties are advised of its receipt.

The time allowed for decision is three days, counting from receipt of goods, after which period, if buyer decides not to retain goods, they must be returned to sender. If a sale is effected, buyer instructs us to remit amount to seller, but if not, seller instructs us to return amount to depositor. Carriage is paid by the buyer, but in the event of no sale, and subject to there being no different arrangement between buyer and seller, each pays carriage one way. The seller takes the risk of loss or damage in transit, for which we take no responsibility. For all transactions up to £10, a deposit fee of 1/- is charged; on transactions over £10 and under £50, the fee is 2/6; over £50, 5/-. All deposit matters are dealt with at Dorset House, Stamford Street, London, S.E.1, and cheques and money orders should be made payable to Lilffe & Sons Limited.

SPECIAL NOTE.—Readers who reply to advertisements and receive no answer to their enquiries are requested to regard the silence as an indication that the goods advertised have already been disposed of. Advertisers often receive so many enquiries that it is quite impossible to reply to each one by post. When sending remittances direct to an advertiser, stamp for return should also be included for use in the event of the application proving unsuccessful.

BUSINESS AS USUAL

at WEST STREET FARNHAM SURREY

Telephone: Farnham 5215

Concentrating on the good cause—Production for Government requirements.

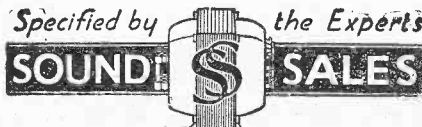

PRODUCTS

can be obtained from the above new address

RADIOMART

G5NI (BHAM) LTD.

THE SHORT-WAVE SPECIALISTS

SPECIAL OFFER!!! Fully shrouded Transformer: by America's largest manufacturer. While they last. All 230 v. primary and fully impregnated. T28705—375/375 v. 150 m/A. 6.3V2A. 2.5V2A. 5V3A. 15/- T19610—350/350 v. 150 m/A. 2.5V2A. 2.5V2A. 5V3A. 12/6 T7236—375/375 v. 120 m/A. 6.3VCT. 4A. 5V3A. 10/6 T7236—350/350 v. 100 m/A. 6.3VCT. 3A. 5V3A. 8/6 T7807—350/350 v. 80 m/A. 6.3VCT. 3A. 5V3A. 7/6 T7600—320/320 v. 80 m/A. 6.3V4A. 5V3A. 7/6 T0925—320/320 v. 80 m/A. 2.5V6A. 5V3A. 7/6 T464919—110V/230 v. 500 watt Auto Transformer. 29/6 T1113AB—110/230 v. 500 watt Auto Transformer. 29/6 The following chokes are interleaved and impregnated. T7007—250 m/A. 135 ohms, 20-8 Hy., cadmium shrouded. 12/6 T7007A—150 m/A. 250 ohms, 30-12 Hy., cadmium shrouded. 12/6 100 m/A. 20 Hy., 500 ohms, unshrouded. 11/1 60 m/A. 15 Hy., 500 ohms. 11/1 HEAVY DUTY TRANSFORMER for models, bells, etc. 6 v. 3 a., 2/3 4 mf., 1,500 v. test 500 v. wkg. oil filled condensers, 2/- HEAVY DUTY Mains Transformer, worth 45/-, 350-350. 150 m/A. 4 v. 2.5 a. CT. 4 v. 6 a. CT. 12/6; 300-300 v., 80 m/A., 4 v. 3 a. CT. 4 v. 2 a., CT. 6/6. Moving Coil Speaker Transformers, power, pentode or push pull 1/1. WB Heavy duty ditto 2/1. GANG CONDENSER with Airplane Dial, 3 and 50-1. Cost 35/-. Few only. 4/11. Utility, 7/6. Microdials, 3/9. W.D. 5in. PERMANENT MAGNET SPEAKERS AT ONE-THIRD COST Extension Type (no Transformer), 5/11. Standard Type (with Transformer) 10/6. Energised 8", 1200 ohms with Transformer, 6/11. PUSHBACK Wire, 6 yds. 6d., heavy 9d. Resin-cored Solder, 6d. 6d.; Screened Flex, single, 6d. yd.; twin, 9d. yd. Assorted Solder Tags, 6d. packet. Humdimmers 6d. each. Central pots, all sizes, 1/6; switched, 2/-; tubular fuses, 2d. Meters, 25 m.a., upwards 5/9. VALVES: Reliable replacements for all types, British and American, showing saving of over 50 per cent. OUR NEW 60-PAGE MANUAL, packed full of valuable information, Communication receivers, transmitters, etc., 7/6, post free. THE NEW RAYMART CATALOGUE shows dozens of New Short-wave Components and is yours for 13d. post free. TRADE ENQUIRIES solicited for: all types of communication equipment, transmitters, receivers, etc.

RADIOMART Telephone: MIDland 3254 G5NI (Birmingham) Ltd. 44, HOLLOWAY HEAD, BIRMINGHAM

NEW RECEIVERS AND AMPLIFIERS

* CHALLENGER Range for 1940. CHALLENGER RADIO CORPORATION.—2d. stamp for illustrated catalogues of battery, battery-mains, car radio, and mains receivers; 63/- to £28; sale list also available. CHALLENGER RADIO CORPORATION, 31, Craven Terrace, London, W.2. Nearest point, Lancaster Gate Station. [8872] ARMSTRONG Co. Can Give Delivery of Practically all 1940 Radio Chassis. ARMSTRONG Recommend the Two Following Economically Priced, powerful chassis, suitable for receiving North and Scottish Emergency Transmitters. ARMSTRONG Model AW38, 8-valve all-wave radio-gram chassis, with 6 watts push-pull output; price 8 gns. ARMSTRONG Model AW93PP 9-valve All-wave Radio-gram Chassis, with radio-frequency pre-amplifier and 8 watts push-pull output; price 10 gns. ARMSTRONG Models AW38 and AW93PP Are Both Efficient on the Important 16, 19, 25, 30 and 50 metre short wave bands. ARMSTRONG Have Illustrated Catalogue Describing Above Chassis and Many Others of Equal Interest. ARMSTRONG Co. Announce that, in accordance with their policy of fair trading, prices of chassis will not be increased until absolutely necessary. ARMSTRONG MANUFACTURING Co. (Head Office), Writers Rd., Holloway, London, N.7. [8883] AMAZING Offer.—Famous 7-valve push-button models in maker's sealed cartons, issued 13 1/2 gns.; £5/19/6; list free.—Shippers, 18, Corporation St., Manchester. [0639]

CAR RADIO

1939 Models from 4 1/2 gns., 6 new car aeriAs, from 9/6; trade enquiries solicited; lists free.—Shippers, 18, Corporation St., Manchester. [0622]

PUBLIC ADDRESS

TANNOY 25 watt Amplifier, Ad-on Unit, A.C. mains, complete; £10.—Easco, 18w, Brixton Rd., S.W.9. [0643] AMPLIFIERS, speakers, converters for sale, cheap.—Joyce, 51, Ramsgate Rd., Margate. Phone 1091. [8879] "PARTRIDGE P.A. Manual," standard handbook on electro-acoustics, amplifiers, and audio circuits; price 2/6 (free to trade). "PARTRIDGE Amplifier Circuits," describes many modern constructional amplifiers, 2w. to 45w. output, battery, A.C.-D.C., etc.; price 2/- (no free copies). PARTRIDGE, N., B.Sc., A.M.I.E.E., King's Buildings, Dean Stanley St., London, S.W.1. [0630]

PUBLIC Address Contractors Can Hire P.A. Vans, loud speakers, microphones and equipments of all types from Hire Dept., Gramplan Reproducers, Ltd., Kew Gardens, Surrey. Tel.: Richmond 1175-67. [0618]

PUBLIC ADDRESS

VORTEXION P.A. Equipment. LIMITED, but unequalled. WE Invite You to a Demonstration. A.C.-D.C. Dance Band Amplifier, 10 watts output, complete in case, with moving coil microphone, speaker and cables, weight 22lb.; 12 gns. A.C.-20 15-20-watt Amplifier, 38-18,000 cycles, independent mike and gram, inputs and controls, 0.037 volts required to full load, output for 4, 7.5, and 15 ohms speakers, or to specification, inaudible hum level, ready for use; 8 1/2 gns. complete. C.P. 20 12-volt Battery and A.C. Mains Model, as used by R.A.F., output as above; 12 gns. A.C.-20, in portable case, with Collard motor, Piezo pick-up, etc., £14; C.P.20 ditto, £17/17. 50-WATT Output 6L6s, under 60-watt conditions, with negative feed back, separate rectifiers for anode screen and bias, with better than 4% regulation level response, 20-25,000 cycles, excellent driver, driver transformer, and output transformer matching 230 ohms impedance electronic mixing for mike and pick-up, with tone control, complete with valve and plugs; £15. COMPLETE in Case, with turntable, B.T.H., Piezo pick-up and shielded microphone transformer; £20. 80-WATT Model, with negative feed back; £25, complete. 120-WATT Model, with negative feed back; £40, complete. 250-VOLT 250 m.a. Full Wave Speaker field supply unit; 25/-, with valve. ALL P.A. Accessories in Stock; trade supplied. VORTEXION, Ltd., 182, The Broadway, Wimbledon, S.W.19. Phone: Lib. 2814. [8241]

NEW MAINS EQUIPMENT

VORTEXION Supply G.P.O., B.B.C., L.P.T.B. Why not you? ALL Models Super Shrouded, primaries screened and tapped, 200-250v., filaments C.T. ANY Model Fitted 5v. or 6.3v. Filaments if Required. 500-0-500 150 m.a., 4v. 4a., 2.5a., 4v. 2a., 4v. 2a., 4v. 2a., 35/-; 400 or 350v., same price. 500-0-500 120 m.a., 4v. 4a., 4v. 2.5a., 4v. 1.2a., 4v. 1.2a., 28/-; 400v. or 450v., same price. 425-0-425 150 m.a., 4v. 8-10a., 4v. 2.5a., 4v. 1a., 4v. 1a., 32/- . 350-0-350 120 m.a., 4v. 4a., 4v. 2.5a., 4v. 1.2a., 21/-; with extra 4v. 6a., 25/- . 350-0-350 75 m.a., 4v. 2-4a., 4v. 1-2a.; 18/- . 250-0-250 60 m.a., 4v. 2-4a., 4v. 1-2a.; 15/- . AUTO Transformers, 100-120 to 200-240v., 80 watts, 11/-; 120 watts, 14/6; 200 watts, 21/-; 250 watts, 25/-; 300 watts, 28/-; 500 watts, 47/6. (This advertisement continued on next page.)

VORTEXION 15W

Type CP20 AC and 12-VOLT DC AMPLIFIER
P.A. EQUIPMENT

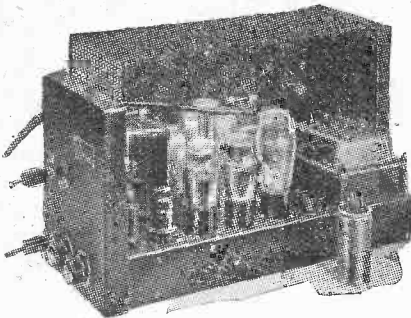

Many hundreds already in use for A.R.P. & GOVERNMENT purposes

THIS small Portable Amplifier, operating either from AC mains or 12-volt battery, was tested by "THE WIRELESS WORLD," October 1st, 1937, and has proved so popular that at Customers' demand it remains unaltered except that the output has been increased to 17.2 watts and the battery consumption lowered to 6 amperes. Read what "The Wireless World" said:—
"During tests an output of 14.7 watts was obtained without any trace of distortion so that the rating of 15 watts is quite justified. The measured response shows an upper limit of 18,000 c/s and a lower of 30 c/s. Its performance is exceptionally good. Another outstanding feature is its exceptionally low hum level when AC operated even without an earth connection. In order to obtain the maximum undistorted output, an input to the microphone jack of 0.337 volt was required. The two independent volume controls enable one to adjust the gain of the amplifier for the same power output from both sources, as well as superimpose one on the other, or fade out one and bring the other up to full volume. The secondary of the output transformer is tapped for loudspeakers or line impedances of 4, 7.5 and 15 ohms."

AC and 12-volt CHASSIS with valves, etc. £12 12 0
Or in Rexine Case with Collaro Motor, Piezo P.U. and Mike Transformer..... £17 17 0
AC only CHASSIS with valves, etc..... £8 18 6
Or in Rexine Case with Collaro Motor, Piezo P.U. and Mike Transformer..... £14 0 0
Gauze Case for either chassis 12/6 extra.

All Components in Stock.
Vortexion Ltd., 182, The Broadway, Wimbledon, S.W.19. Phone: LIBerty 2814.

BUSINESS AS USUAL

PREMIER

★ RADIO ★

REPLACEMENT VALVES FOR ALL SETS

EUROPA MAINS VALVES, 4 v. A.C. Types, A.C./H.L., A.C./L., A.C./S.G., A.C./V.M.S.G., A.C./H.P., A.C./V.H.P., A.C./P., and 1 watt D.H. Pentodes, all 4/6 each. A.C./Pens., I.H., 5/6; A.C./P.X.4, 6/6; Oct. Freq. Changers, 8/6; Double Diode Triodes, 7/6; 3½-watt D.H. Triode, 7/6. 350 v. and 500 v. F.W. Rect., 5/6. 13 v. 2 amps. Gen. Purpose Triodes, 5/6; H.F. Pens. and Var.-Mu. H.F. Pen., Double Diode Triodes, Oct. Freq. Changers, 7/6 each. Full and Half-wave Rectifiers, 5/9 each.

PREMIER SHORT-WAVE KITS for OVERSEAS NEWS

Complete to the last detail, including all Valves and coils, wiring diagrams and lucid instructions for building and working. Each Kit is supplied with a steel Chassis and Panel and uses plug-in coils to tune from 13 to 170 metres.
1 Valve Short-Wave Receiver or Adaptor Kit ... 17/6
1 Valve Short-Wave Superhet Converter Kit ... 20/-
1 Valve Short-Wave A.C. Superhet Converter Kit ... 22/6
2 Valve Short-Wave Receiver Kit ... 25/-
3 Valve Short-Wave Screen Grid and Pentode Kit ... 58/6

TRIAD U.S.A. VALVES

Reduced Prices maintained while stocks last. All goods previously advertised still available.

NOW READY

PREMIER 1940 CATALOGUE

111 PAGES PRICE 6d.

Over 20 Pages of British and U.S.A. Valve Data, Receivers, Amplifiers, Components, GET YOUR COPY TO-DAY!

ALL POST ORDERS TO: Jubilee Works, 167, Lower Clapton Road, London, E.5. Amherst 4723
CALLERS TO: Jubilee Works, or our NEW PREMISES, 169, FLEET STREET, E.C.4. Central 2833
or 50, High Street, Clapham, S.W.4. Macaulay 2381

NEW MAINS EQUIPMENT

(This advertisement continued from previous page.)

W.W. Q.A. Output Transformer; 21/-.
MICROPHONE Transformers, in heavy magnetic shielding; 12/6.
CHOKES—30h., 60 m.a., 7/6; 7-13h., 120 m.a., 12/6; 30h., 150 m.a., 15/-; 25h., 150 m.a., 21/-.
TRANSFORMERS and Chokes to Any Specification.
CAR Battery Chargers, 6 and 12v., 1½ to 2 amperes; 30/- complete.
VORTEXION, Ltd., 182, The Broadway, Wimbledon, London, S.W.19. Telephone: Liberty 2814. [8885]

NEW LOUD-SPEAKERS

BAKERS New Corner Horn Speakers, triple cone conversions; from 29/6, and surplus speaker bargains. —Bakers Selhurst Radio, 75, Sussex Rd., South Croydon. [8728]

VOIGT PATENTS, Ltd., announce that as their staff belongs to a reserved occupation, and is not yet required for National Service, production continues. "The wheels of the Nation must be kept in motion." "W.W." readers intending to buy a Voigt Speaker are therefore earnestly requested to do so now, and enable our full staff to be kept in employment until required by the Government.—The Courts, Silverdale, S.E.25 [8884]

TRANSMITTING APPARATUS

A.C.S. RADIO, specialists in short wave apparatus, communication receivers, including Hallicrafters, National and R.M.E. transmitting equipment, valves and components. Send for free catalogue to A.C.S. Radio, 16, Gray's Inn Rd., W.C.1. Holborn 9894-5. G2NK, Technical Manager. [0550]

G5N1—The oldest and largest distributor of amateur equipment transmitting and receiving; short-wave catalogue, 1½d. G5N1 70-page Manual, 7½d., post free; authorised direct distributor for Collins, National, R.M.E., Thordarson, Hammerlund, Biley, Taylor, Elmac, etc., etc.—44, Holloway Head, Birmingham. [0531]

CABINETS

A CABINET for Every Radio Purpose.
CONVERT Your Set into a Radiogram at Minimum Cost; surplus cabinets from noted makers under cost of manufacture (undrilled); 30/- upwards; motors at wholesale prices.
"FIL-A-GRAM" Cabinet, 31x17x15, 21/-.

UNDRILLED Table Console and Loud-Speaker Cabinets from 3/6.
INSPECTION invited; photos loaned to country customers.
H. L. SMITH and Co., Ltd., 289, Edgware Rd., W.2. Tel.: Pad. 5891. [0482]

DYNAMOS, MOTORS, ETC.

ALL Types of Rotary Converters, electric motors, battery chargers, petrol-electric generator sets, etc., in stock, new and second-hand.
A.C.D.O. Conversion Units for Operating D.C. Receivers from A.C. Mains, 100 watts output, £2/10; 150 watts output, £3/10.
WARD, 46, Farringdon St., London, E.C.4. Tel.: Holborn 9703. [0518]

RECORDING EQUIPMENT

FEIGH Recording Sets are Within Reach of All; ball bearing gear box, worm drive reverse; records on any disc, Morse, speech or music; diamond cutter-pickup on tone arm, the set 37/6; 6in. blanks, 3/3 doz.; 10in. discs, 7/- doz.—Electradix, 218, Upper Thames St., London, E.C.4. [0620]

VALVES

SPECIAL Line of Rogers and Majestic Tubes, types 551, 227, 551s, 55s, 6B7, 56 and 58, 2B7, 6 red 5 and 53; 3/6.
ALL Types of American Tubes in Stock of Impex and Arcurus makes at competitive prices.
WE Can Also Supply a Full Range of Guaranteed Replacement Valves for Any British non-ring, American or Continental type at an appreciably lower price. SEND for Lists of These, and also electrolytic condensers, line cords, resistances, etc.
CHRIS. F. WARD, 46, Farringdon St., London, E.C.4. Tel.: Holborn 9703. [0452]

AMERICAN, 2/9; 1,000 non-ring British from 1/9; bargains galore; lists free.—Shippers, 18, Corporation St., Manchester. [0607]

METROPOLITAN RADIO SERVICE.—Special offer. American valves, in maker's cartons, 3/- each, Octals, 3/6 each; American valves, first grade, in all types; trade supplied.—1021, Finchley Rd., N.W.11. Speedwell 3000. [0436]

4/- Each.—R.C.A., Raytheon, other good makes, all types; 2/6 each, good quality cheaper grade, all types; post 3d. cash with order or c.o.d. Transmitting tubes, photo cells, exciters; keen prices.—Howard, Ambrose, 19, Wellington St., Glasgow. [8880]

COMPONENTS

SECOND-HAND, CLEARANCE, SURPLUS, ETC. PREMIER SUPPLY STORES.

PLEASE See Our Displayed Advertisement on this page. [0488]

COULPHONE RADIO, Ormskirk.—Supplies as usual; quick service; 1½d. stamp for 1940 catalogue. [8888]

VAUXHALL.—All goods as previously advertised still available; write for free list.—Vauxhall Utilities, 163a, Strand, W.C.2. [8727]

SOUTHERN RADIO, 46, Lisle St., London, W.C. Gerard 6653.—Stocks of receivers and replacement components as previously advertised. [8548]



The Man with a Future is the TRAINED Man

The man who soon will be in a much better position than he occupies to-day is the man who is devoting some of his spare time to vocational study NOW. He knows that training is the best means of strengthening his salary-earning ability.

Through spare-time study ambitious men everywhere have risen to positions of responsibility. They developed their natural faculties, and so progressed in an era of constantly increasing competition. Tens of thousands are doing so to-day. They are the men with a future.

If you are dissatisfied with your present prospects, if you desire bigger pay, promotion, let the I.C.S. advise you, free and without obligation. Write, or fill in and post the coupon. But don't delay.

-----COUPON FOR FREE BOOKLET-----

INTERNATIONAL CORRESPONDENCE SCHOOLS LTD Dept. 38, International Buildings, Kingsway, London, W.C.2.

Please send me free booklet describing I.C.S. Courses in the subject I have marked X. I assume no obligation.

RADIO ENGINEERING RADIO RADIO SERVICING TELEVISION

- ACCOUNTANCY
- ADVERTISING
- AERONAUTICAL ENG.
- AIR CONDITIONING
- ARCHITECTURE
- BOOK-KEEPING
- BUILDING
- BUSINESS TRAINING
- CHEMICAL ENG.
- CIVIL ENGINEERING
- COMMERCIAL ART
- DIESEL ENGINEERING
- DRAUGHTSMANSHIP
- ELECTRICAL ENG.
- GENERAL EDUCATION
- HORTICULTURE
- INSURANCE
- JOURNALISM
- LETTERING
- MECHANICAL ENG.
- MOTOR ENGINEERING
- PLUMBING
- SALESMANSHIP
- SANITARY ENG.
- SECRETARIAL WORK
- SHORT-STORY WRITING
- SURVEYING
- WELDING
- WOODWORKING
- WORKS MANAGEMENT

EXAMINATIONS: Technical : Professional : Civil Service : Matriculation (including Inst. Wireless Tech., P.M.G. Certif. for Wireless Operators, City & Guilds Radio Comm., and Prov. Certif. in Radio Telephony and Telegraphy for Aircraft).

State your Exam. here.....
Name.....Age.....
Address.....

Greatest, largest and most famous of all institutions devoted to spare-time training by the postal method. Branches in 30 countries, students in 50.



COMPONENTS—SECOND-HAND CLEARANCE, SURPLUS, ETC.

R. RADIO CLEARANCE, Ltd., 63, High Holborn, W.C.1. Phone: Holborn 4631. CO-AXIAL Cable, finest quality for television lead-in; heavy vulcanised tough rubber insulation closely meshed screen; single, 6d. per yard; twin, 9d. per yard. FILAMENT Transformers.—Input 200-250 volts, output 4-volt 4 amps., 4-volt 6 amps., 4/11 each. MAINS Transformers.—American windings, input 200-250 volts, tapped; output 350-0.350 100 m/A., 5-volt 2 amp., 6.5 volts 5 amp., 7/11 each. G.E.C. Mains Transformers.—American windings, 350-0.350 65 m/A., 5-volt 2 amp., 6.3-volt 2.5 amps., suitable for replacements in G.E.C. models, 5/6 each; auto transformers, 103-230-volt, 5/11 each. ELECTROLYTIC Condensers.—Plessey 8x4x4x4 mfd. 570-volt working, 2/- each; 24 mfd., can-type electrolytics, 450-volt working, 10d. each; 8x8 mfd., 450-volt working, 1/- each; T.C.C. 8 mfd., can-type, wet electrolytics, 450-volt working, 1/3 each. POLAR N.S.F. Resistances.—1 gross parcels of 1/4- and 1/2-watt resistances, all good sizes, our selection; 4/6 each. PRESS-BUTTON Units, with 6 press buttons, ready for wiring into set, with circuit, 6/11 each. BULGIN.—20 ohms wire-wound pots, 1/- each; stranded push-back wire, 1d. per yard; 12 yards, 10d. YAXLEY Switches.—2-pole, 4-way, 3-bank, 1/6 each; 2-pole, 5-way, 4-bank, 2/- each. CHASSIS Mounting Valve Holders.—American, 4, 5, 6- and 7-pin, 3d. each; Octal, 4d. each; Local, 8d. each; 7-pin English type, 2d. each. SET of Three Manufacturers' Type All-wave Coils, 13-2,000 mers, including oscillator, aerial and I.F., with three-gang straight condenser, 2/6 the set of three; wave change switch for above, 2/- each. ROTHERMEL Piezo Crystal Speakers.—7/8 in. cone, list 55/-; our price, 9/6 each. G.E.C. Relays, make and break type, 3,300 ohms, 4/- each. CRYSTAL Pick-up.—High-grade American, bronze finish, complete with arm, £1/5 each. POLAR N.S.F. 1-watt Resistances.—3/4d. each, 3/- doz., all sizes up to 2 meg. MAINS Smoothing Choke.—Wearite unshrouded fitted wire ends; 30 henry 80 m/A., 500 ohms, 7/6 each; 40 henry 150 m/A., 500 ohms, 10/6 each. WEARITE Mains Transformers.—Made to strict electrical standards, wire-end type, all windings centre tap; screened primaries, tapped inputs 200-250 volts, screw adjustment; type R.C.2, 350-0.350 120 m/A., 4 volts 2.5 amp., 4 volts 5 amp., 11/- each; Type R.C.3, 350-0.350 150 m/A., 1 volt 2.5 amp., 4 volts 2 amp., 4 volts 5 amp., 12/6 each; Type R.C.4, 500-0.500 150 m/A., 4 volts 2 amp., 4 volts 2 amp., 4 volts 2.5 amp., 4-volt 5 amp., 19/6 each; R.C. drop-through type, capped; R.C.3 and R.C.4, upright mounting type, fully shrouded. AMERICAN C.T.S. Volume Controls.—Finest made. Divided spindles length 2 1/2 in., with switch; 2,000, 5,000, 10,000, 25,000, 50,000, 100,000, 250,000, 500,000, 1 meg, 2/- each; less switch, 50,000, 100,000, 500,000, 1/9 each; wire-wound 5-watt (less switch), 2,000, 10,000, 25,000, 50,000, 2/- each. BRADLEY Ohm Wire-wound Volume Controls, with switch, 600,000 ohms, 1/- each. BULGIN Single-pole Single Throw Twist Switches, 3d. each. PILON Bulbs, 6.3 volts, 0.3 amp., 3d. each; Wearite screen H.F. chokes, 1/- each. HEAVY-DUTY Speech Transformers, 2/11 each. T.C.C. Cardboard Electrolytics, wire-end type, sizes 2 1/2 in x 1 1/2 in., 500-volt working, 600-volt surge, 8 mfd., type "Minor," 1/6 each; 8 plus 8, 4 lead, type "Minor," 2/6 each; 8 mfd. midjet tubular, wire end, 500-volt working, 600-volt surge, 1/6 each; bias wire-end type, 25 mfd., 25-volt, 1/3 each; 50 mfd., 12-volt, 1/- each; 50 mfd., 25-volt, 1/3 each; 25 mfd., 25-volt, 1/- each; 50 mfd., 50-volt, 1/6 each; tubular, wire end, non-inductive paper, all sizes up to 0.1, 4/6d. each, 4/- dozen; metal case, 1-hole fixing, electrolytic condensers, 500-volt working, 600-volt surge, 8 mfd., 2/6 each. STANDARD Telephone Headphones Resistance, 2,000 and 4,000 ohms, 9/11 per pair. RAYTHEON First Grade Valves, largest stockists, all types in stock, including Glass Series, Glass Octal Series, Metal Series, Local Series, Bantam Series Single-ended Metal Series, and Resistance Tubes; all at most competitive prices; send for lists. ALL Orders Must Include Sufficient Postage to Cover; Hours of business: 9 a.m.-6 p.m., Saturdays 9 a.m.-1 p.m. RADIO CLEARANCE, Ltd., 63, High Holborn, London, W.C.1. Telephone: Holborn 4631. [8887] MAINS RADIO DEVELOPMENT COMPANY are Continuing their Super Service under Management of Proprietor's Wife. Stamp for List 230.—Please note new address, 52a, Church Crescent, Muswell Hill, N.10. ERIE Unused Resistors.—One-watt, all sizes, 3d. each, 2/6 dozen; 2-watt, 6d. CENTRALAB Latest Long-spindle Potentiometers, all sizes, 2/- with switch, 2/3. DUBILIER Unused Midjet Tag Condensers, 0.00005 to 0.0005, 3d.; Clix valve-holders, 5-, 7-pin, 4d.; American sizes, 6d. TUBULAR Condensers, new, 400v.w., non-inductive, best make, all sizes to 0.1 mfd.; 4d. FIFTY Unused N.S.F. Resistors, fine assortment, 1/2, 1 and 2 watt, wire ends, 2/6 per 50. [8881]

A.R.P. HELPS

RAID BELLS. ALARM BELLS. Mains, battery or magneto waterproof types. Priority for A.R.P. STEEL CASED OUTDOOR SIGNAL MIKES AND BATTERY, £5/-. SHELTER PHONES. Portable Emergency Telephone stations in case, 60/- D3, X135, 119 and other Army Field Phones. A.R.P. only. 5-line Exchanges for underground groups. 30-line Exchanges for large A.R.P. shelters. POCKET HEADPHONES. W.D., all leather headband, strap and cords, 2/6 pair. Wireless type, with aluminium headbands, 2/9. 4,000 ohms, 4/6. CABLE. Lightweight twin field cable, unbreakable Army steel-reinforced, 55/- mile. Heavier types, 65/- and 70/- FIRE CONTROL SIGNALS. Emergency day Lucas and Aldis Hooded Army Signal lamps, telescopic sights, hand or tripod. For Fire Brigades and Police, 60/- SHELTER, A.R.P. Ventilation and Air Conditioning. A.C. or D.C. mains, 80 watts; 9in. Blower, 20 cub. ft. fresh air per min., 25/- ELECTRIC PUMPS, for A.C. or D.C., 12 v. to 230 v., Centrifugal all-bronze pump, throws 120 gals. per hour. 6ft. Caravans, Bungalows and Boats, 67/6. Larger pumps for draining shelters, dug outs, etc., £5/10/- BUZZERS, BUZZERS, BUZZERS for all purposes. The well-known robust Model D. For Morse Practice or Signals. Now supplied for 1/- only. Morse Practice Sets, No. 3, with key buzzer and lamp for sound and visual, line plug, etc., 7/- Sound Type, 1A type key and buzzer, 3/- Visual Type 2A, key and lamp, 2/- KEYS. Govt. surplus Morse Keys. Type KBSL. Massive brass pivot bar, spring-mounted contacts and base lamp for night, 7/6. Walters Service lathe enclosed Key, for high voltage, 10 amp. contacts, good bridge key, 10/6. Super Keys, Brown's Car-patrol, double acting, beautifully made and balanced, totally enclosed, cast All. cover, for H.T., 21/-

DUG-OUT CRYSTAL SETS. Model B, Pol. Mah. case 9in. x 10in., 2 tuning, condensers, plug-in coils, Permanent Detector, 7/6. Phones, 4/6. YOU MUST KEEP YOUR BATTERY PREPARED!!! Battery Charging, on A.C. Mains. The A.C. NIENDAY will keep your battery fit without attention. Model N/A5, 100/250 volts A.C. and D.C. 6/8 volts 1 amp., 15/- Model N/B6, 100/250 volts to D.C. 6/8 volts 2 amps., 35/- Model N/C6, 100/250 volts to D.C., 6/8 volts 2 amps., 35/- Model N/D12, 100/250 volts to 12 volts 1 amp., 32/- Ditto, 12 volts 2 amps., with 6-volt tap, 55/- 3 amp., £4/10/-

A.R.P. PETROL ELECTRIC GENERATING SETS for Lighting and Charging. Half-h.p. DIRECT COUPLED. 150 watts D.C., 1,300 r.p.m., 2-stroke water-cooled 1-cyl. Engine, magneto ignition. On bedplate with 30 volts 5 amps. Dynamo, £12. 90 Larger size 1 kW. S.P. Petrol Electric Sets, 500 watts, 2-stroke water-cooled 1 h.p. 1 cyl. engine on bedplate direct-coupled to 50/70 volts 10 amps. D.C. Dynamo, magneto ignition, fuel and oil tank, £18.

A.R.P. EDISON HIGH CAPACITY STEEL CELLS at half price for standby lighting, 120A.H. to 300 A.H. at 25/- to 25/- Makers Price is 25. Ask for leaflet. FULL PARTICULARS gladly given as far as we are able to A.R.P. ENQUIRIES. 5/- EMERGENCY PARCELS of useful standby electrical and radio repair material and apparatus, 10 lbs. for 5/- Post free.

Don't forget to send now for our Bargain List "W" ELECTRADIX RADIOS 218, UPPER THAMES STREET, LONDON, E.C.4 Telephone: Central 4611

THE INSTITUTE OF WIRELESS TECHNOLOGY (Founded in 1925. Incorporated.) EXAMINATION ENTRIES Candidates for the November Examinations must apply not later than September 30th. Application Forms and Syllabus may be obtained from the Secretary:—Harrie J. King, F.C.C.S., Institute of Wireless Technology, 4, Vernon Place, Southampton Row, London, W.C.1. Phone: Holborn 4879.

Be quite a lot of business making up transformers to customers' own specifications but we have a standard list. May we send you a copy? W. BRYAN WESTMORELAND RD. LONDON N.W.9 SAVAGE LTD PHONE COLINDALE 7131

ANNOUNCEMENT Firms experiencing difficulty in obtaining Transformers and Chokes from their usual source of supply, owing to Government orders taking priority, should get into touch with us at once. We are in a position to give immediate delivery and invite your enquiries. N. PARTRIDGE B.Sc., A.M.I.E.E. KING'S BLDGS., DEAN STANLEY ST., LONDON, S.W.1. Phone: Victoria 5035

COMPONENTS—SECOND-HAND CLEARANCE, SURPLUS, ETC.

RYALS RADIO, 280, High Holborn, London, W.C.1. offer new goods, post free. ELLIPTICAL Speakers, Celestion, suitable Ekco replacements, 750 and 1,250 ohms, less transformers, speech 25 ohms, new, handle 8 watts, carry up to 120 m.a., 5/6 each. SPEAKERS, pairs, brand new, elliptical cone speakers, made by first class firm, quality of reproduction outstanding, push-pull pentode transformer, fields 325 ohm for smoothing choke, 8,600 as bleeder, circuit available, handle 10-15w.; 14/- pair. HEAVY Duty Mains H.F. Chokes, Goltone, 75w. high inductance type, 1/6; 180w. low inductance type, 1/- MAINS Transformers, drop through chassis type, top cover with mains adjustment, input 200-250v., outputs 350-350, 80 m.a. 4v. 2 1/2ga. 4v. 4.5 amp., heavy jobs, 6/9 each. MAGNAVOX 7in. Core Speakers (8in. overall), ribbed pattern ideal replacement speakers, 2,000 ohms pentode transformers; 7/-, new. SATOR 2meg. Pots with Switch, 1/3 each, 7/9 dozen; 10,000 ohm broad base tone control type, less switch, 1/3 each, 6/9 dozen. AMPLIFIERS for A.C. 200-250v. Input, 3-stage single 6L6 output, with pair energised elliptical speakers, and Ferranti output transformer, output 12 watts; 47/6, all wired complete with valves and speakers. [8886]

REPAIRS AND SERVICE

GUARANTEED Repairs, Any Transformers, choke, motor armature, converter, dynamo, etc. keenest prices, immediate quotation, prompt, dependable service.—See below. L.T.P. (LONDON TRANSFORMER PRODUCTS, Ltd.), Willesden, N.W.10. Willesden 6486 (3 lines). [6892]

MAINS Transformer Service, Repairs, rewinds, or construction to specification of any type, competitive prices and prompt service.—Sturdy Electric Co., Dip-ton, Newcastle-on-Tyne. [0516]

METROPOLITAN RADIO SERVICE.—Guaranteed repairs to American and British receivers; American valves, service parts and rewinds; trade supplied.—1021, Finchley Rd., N.W.1. Speedwell 3000. [0435]

REPAIRS to Moving Coil Speakers a Speciality; cones and coils fitted, fields altered; prices, including eliminators, quoted; loud speakers, 4/-; L.F. and output transformers, 4/-, post free, guaranteed satisfaction; trade invited estimates free; prompt service.—Loud Speaker Repair Works, 5, Balham Grove, London, Battersea 1321. [0394]

SITUATIONS VACANT

EXAMINERS and Testers Required in Factory Producing Radio Receivers and Transmitters for the Services; permanent and interesting work for good men; Croydon district.—Write, stating age, salary and experience, Box 952, c/o The Wireless World. [3882]

MISCELLANEOUS

EVERY Radio Dealer Who is Not a Regular Reader of "The Wireless and Electrical Trader" should send his trade card at once for a specimen copy and full details of the "Trader" Services. "The Wireless and Electrical Trader" has the widest influence, the largest weekly circulation, and is read by all the leading manufacturers and traders. Trade only, 15/- per annum, post free.—Published at Dorset House, Stamford St., London, S.E.1. [0615]

"ENGINEER'S Guide to Success" Shows How to Qualify in Television Radio Engineering and Servicing, sound, recording, wireless communicating, etc., by studying at home with the I.C.B.B. Write to-day for this Great Guide—free—which gives full particulars, contains the world's widest choice of engineering courses—over 200—and also gives the regulations for qualifications such as A.M.I.E.E., A.M.I.R.E., A.M.I.T.E., A.M.I.W.T., C. and G., etc. Training until successful guaranteed.—The Technological Institute of Great Britain, 82, Temple Bar House, London, E.C.4. (Founded 1917. 20,000 successes.) [8872]

TUITION

RADIO Training.—P.M.G. exams, and I.E.E. Diploma; prospectus free.—Technical College, Hull. [0611] PRACTICAL Postal Courses, radio television; test equipment design; I.P.R.E. and I.W.T. exams.—Write I.P.E., 3, Shirley Rd., London, W.4. [8838]

PATENT AND TRADE MARK AGENTS

GEE and Co. (H. T. P. Gee, Mem. R.S.G.B., etc.), 51-52, Chancery Lane, London, W.C.2. Holborn 4547-8. Handbook free. [7001]

BUSINESSES AND PROPERTY FOR SALE, TO BE LET, OR WANTED

"THE Wireless and Electrical Trader" is an essential part of the equipment of every Wireless Trader; its pages reflect the very latest turn of trade events, and it is read by all the leading dealers and manufacturers, for particulars of businesses offered or wanted. By subscription to the trade only, 15/- per annum, post free.—Send your trade card for specimen copy to Dorset House, Stamford St., London, S.E.1. [0614]

BOOKS, INSTRUCTION, ETC.

AMERICAN Valve Data.—The 200-page Raytheon Data Book gives full characteristics, applications, all types American valves; invaluable to servicemen; post free anywhere; 2/3.—Leonard Heys, 36, Henry St., Blackpool. [0594] ALL Wireless and Radio Engineering Books Available through new financial terms as low as 2/6 monthly.—Write a card or call personally for details and lists from the Radio Department, Phoenix Showrooms, 66, Chancery Place, Strand. [8623]

Pamphonic AMPLIFIERS Pamphonic Reproducers Ltd. (Associated with P.Y.E. Ltd.) 45, St. Paneras Way, London, N.W.1. Phone: EUSton 1727.



YOU NEED THIS BOOK

"The All-Metal Way" contains 56 pages of technical information and circuits relating to rectification, and includes chapters on radio power supply, L.T. and H.T. battery charging, telephony monitoring, reduction of interference, etc., etc.

COUPON

WESTINGHOUSE BRAKE & SIGNAL CO., LTD.
82, YORK WAY, KING'S CROSS, LONDON, N.I.

Please send me a copy of "The All-Metal Way" for which I enclose 3d. in stamps.

NAME

ADDRESS

W.W. 14/9/39



SOUND AMPLIFYING EQUIPMENT

Rack and Panel or Portable Equipments to suit particular requirements

AMPLIFIERS—Units of 10 to 120 watts undistorted output. (Volume expansion and contraction when required).

MICROPHONES—Carbon, Ribbon, or Moving Coil.

SPEAKERS—
Indoor :— 6 ins. to 10 ins. Cone P.M. units.
Outdoor :— 3 ft. and 6 ft. Horns ; metal diaphragm units.

When sending in your enquiries, please state approximate area to be served, and power supply.

To Sound Reproducer Sales—

BTH RUGBY

THE BRITISH THOMSON-HOUSTON COMPANY LIMITED, RUGBY, ENGLAND A2710N

CUT HERE

EMERGENCY ORDER FORM

Order your WIRELESS WORLD in advance.

Please place a regular order for the WIRELESS WORLD with your newsagent if you wish to be certain of securing a copy each week. In future it is unlikely that newsagents will have copies available unless they are definitely ordered in advance.

Please reserve/deliver The WIRELESS WORLD every week until further notice.

NAME..... Date.....

ADDRESS.....

SUBSCRIPTION RATES

If you wish to receive your copy direct by post the following subscription rates apply :—
For One year - £1.10.4
" Six months - 15.2
" Three months - 7.7

Enclose remittance with order.
ILIFFE & SONS LTD.
Dorset House, Stamford Street,
London, S.E.1. Phone : WATerloo 3333

The WIRELESS WORLD will continue to supply you with essential technical information and wireless news and in national work the WIRELESS WORLD will be of the greatest importance to you.

SIGN & HAND TO YOUR NEWSAGENT TO-DAY

Mention of "The Wireless World," when writing to advertisers, will ensure prompt attention.

—Third Edition of

WIRELESS DIRECTION FINDING

BY R. KEEN, B.Eng.

A BOOK OF INSTRUCTION AND REFERENCE FOR ENGINEERS, TECHNICIANS, TELEGRAPHISTS AND OTHERS ENGAGED OR INTERESTED IN THE USE OF DIRECTIVE WIRELESS TELEGRAPHY FOR THE NAVIGATION OF SHIPS AND AIRCRAFT

The third edition of this well-known book deals with the principles of Wireless Direction Finding and gives an account of the circuits and apparatus used in its application to navigation. The Adcock Aerial has a separate chapter covering its principles together with much information on its installation and performance. Further chapters are included on Shore, Ship and Aircraft installations as well as a special section on the choice of a suitable site for the Aircraft Ground D.F., with Adcock Aerials.

Engineering students and research engineers will find useful references to a selected list of some 600 of the more important contributions to the literature of D.F.

800 pages 550 illustrations

PRICE 25/- net By post 25/9

From leading Booksellers or direct from the Publishers :

ILIFFE & SONS LTD., DORSET HOUSE, STAMFORD STREET, LONDON, S.E.1

Sixth EditionRevised and Enlarged**HANDBOOK of
TECHNICAL INSTRUCTION for
WIRELESS TELEGRAPHISTS**

by H. M. DOWSETT

(M.I.E.E., F.Inst.P., M.Inst.R.E.)

This standard handbook is planned primarily for the use of wireless operators, whether prospective or actual. It is virtually a complete theoretical course for students wishing to qualify for the Postmaster-General's Certificate of Proficiency.

CONTENTS INCLUDE :

The Electric Charge and the Condenser—The Condenser in Practice—Direct Current and Ohm's Law—Scalar and Vector Quantities and Curve Plotting—Primary Batteries—Accumulators—Magnetism—Electro Magnetism—Self-Induction—Dynamo Electric Machines—Measuring Instruments—Switchboards and Switchgear—Alternating Current Effects, and Vector Diagrams—Alternating Current Fundamental Formulae—Alternating Current Generators, Alternating Current Motors and Transformers—Damped Oscillations—Commercial Types of Spark Transmitter—Aerials and Radiation—Simple Receiver Circuit and Crystal Detector—Thermionics and the Various Applications of the Valve—Depth Sounding—Valve Transmitters—Wavemeter and Transmitter Adjustment—Theory of Valve Receiver Circuits—Valve Receivers—Short Wave Aerials and Apparatus—Marine Direction Finders—Marine Audio Relay Service—Distress Call Apparatus—Lifeboat and Emergency Outfits—Trawler Apparatus—Maintenance of Marine Radio Installations and Possible Faults.

PRICE 21/- By post 21/9

By Foreign Post 22/-

Obtainable from leading booksellers or direct from the Publishers :

ILIFFE & SONS LTD., DORSET HOUSE, STAMFORD STREET, LONDON, S.E.1

The **Wireless** **World** **6^D**
THE PRACTICAL RADIO & TELEVISION JOURNAL

Thursday, September 21st, 1939

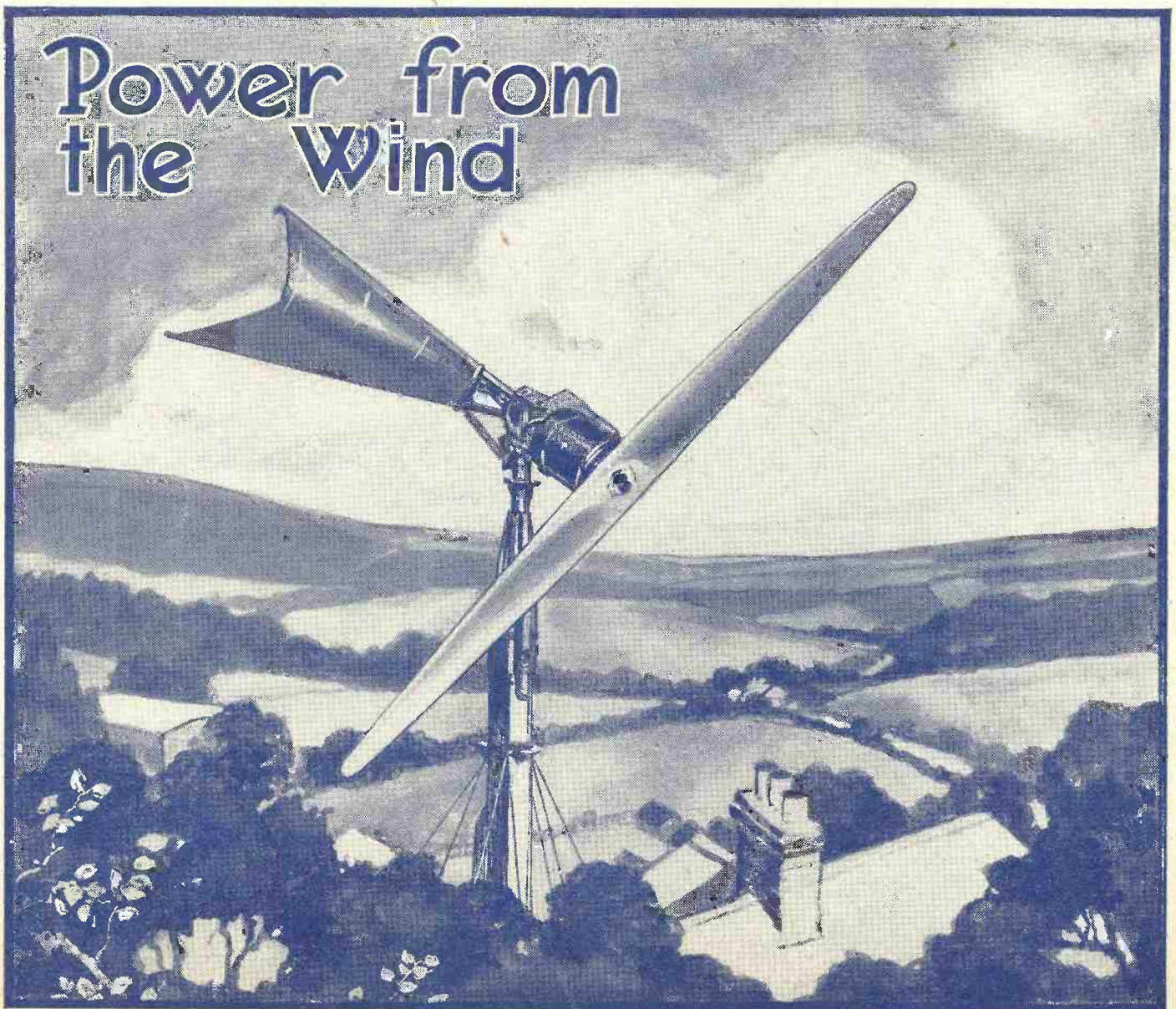

In these days of emergency

*Don't forget that your
radio receiver is more
important than ever.
Rejuvenate it with
new Osram Valves—
keep a spare set handy.*

Osram Valves

MADE IN ENGLAND

A TONIC TO ANY SET

NOTE. *If you have difficulty in obtaining any particular valves, write to the Osram Valve Dept. of:*

THE GENERAL ELECTRIC CO., LTD.,
Magnet House, Kingsway, London, W.C.2.

The Wireless World

THE PRACTICAL RADIO JOURNAL
29th Year of Publication

No. 1047

THURSDAY, SEPTEMBER 21ST, 1939

VOL. XLV No. 12

Proprietors : ILIFFE & SONS LTD.

Editor :
HUGH S. POCOCK.

Editorial,
Advertising and Publishing Offices :
DORSET HOUSE, STAMFORD STREET,
LONDON, S.E.1.

Telephone : Waterloo 3333 (50 lines).
Telegrams : "Ethaworld, Sedist, London."

COVENTRY : 8-10, Corporation Street.
Telegrams : "Autocar, Coventry." Telephone : 5210 Coventry.

BIRMINGHAM :
Guildhall Buildings, Navigation Street, 2.
Telegrams : "Autopress, Birmingham." Telephone : 2971 Midland (5 lines).

MANCHESTER : 260, Deansgate, 3.
Telegrams : "Iliffe, Manchester." Telephone : Blackfriars 4412 (4 lines).

GLASGOW : 26B, Renfield Street, C.2.
Telegrams : "Iliffe, Glasgow." Telephone : Central 4857.

PUBLISHED WEEKLY. ENTERED AS SECOND CLASS MATTER AT NEW YORK, N.Y.

Subscription Rates :
Home and Canada, £1 10s. 4d. ; other countries, £1 12s. 6d. per annum.

As many of the circuits and apparatus described in these pages are covered by patents, readers are advised, before making use of them, to satisfy themselves that they would not be infringing patents.

CONTENTS

	Page
Editorial Comment	267
Headphone Listening. By R. H. Wallace	268
Problem Corner	270
Power from the Wind. By A. W. Beall	271
Above Three Megacycles	272
Grid-blocking in RC Amplifiers	273
Random Radiations	275
Unbiased. By Free Grid	276
News of the Week	277
Scanning Coil Construction (Concluded). By P. D. Tyers	279
Sight and Sound. By "Cathode Ray"	281
Murphy A76 : Test Report	283
Letters to the Editor	285
Recent Inventions.. ..	286

EDITORIAL COMMENT

Wireless Personnel

Avoiding Waste of Man Power

THERE can be no doubt that during the war of 1914-1918 we and our allies benefited more from wireless communication than did our enemies. In a comprehensive survey of the part radio played in that struggle, Mr. R. N. Vyvyan, formerly Engineer-in-Chief of the Marconi Company, said in his book *Wireless Over Thirty Years* that in the absence of wireless communication it is probable that the German submarine campaign would have been successful. With regard to naval warfare, the situation would also have been altered profoundly in favour of the enemy, as the British fleet would have had to keep constantly at sea.

Conditions may have changed during the past twenty-one years, but, as we see it, in no material respect has the position become fundamentally different. The higher speeds of surface craft and aircraft make rapid communication more essential than ever, and the use of aircraft for anti-submarine patrols, disclosed in a recent official communique, opens up obvious new opportunities for wireless, which, we are convinced, will play a prominent part in bringing about the final overthrow of Hitlerism.

In 1914 there was a certain amount of wastage of technical ability. Skilled wireless operators and other technicians were called up for Territorial or other non-specialised Army duties, while others, not realising the national importance of their work, volunteered for general combatant service. True, these men were ultimately transferred back to duties for which their qualifications fitted them, but there was a certain amount of waste and confusion.

Later on, when the various wireless services were hastily expanded, efficiency suffered in some directions through insufficient training of personnel. Fortunately, however, there were enough highly skilled men for the more vital wireless branches, and their abilities were not wasted.

After the crisis of September, 1938, *The Wireless World*, thinking along the lines just set forth, offered its services to the Government in establishing a National Register of those possessing wireless knowledge and experience of a kind likely to be useful in time of war. Our offer was accepted, and shortly afterwards we published a registration form on behalf of the Wireless Telegraphy Board. Response from our readers was good, and the authorities now have access to a fairly comprehensive list from which it should be possible to find the right man for almost any wireless job. There is no reason why the confusion of 1914 should again arise.

Though the needs of the fighting Services and of the Merchant Navy must come first, maintenance of broadcasting is also vital. Letters we have received from servicemen show that, though anxious to play their part in some more active sphere, many feel that their abilities are being best employed in their present work. The quandary in which some of our correspondents find themselves is to make a decision on this point. As we see it, the matter is one that depends on the qualifications and experience of the individual, and each one must decide for himself. We contend, however, that the maintenance of civilian broadcast receivers is an essential service, and, as those capable of carrying it out are almost all young men, adequate steps should be taken by the authorities to ensure its continuance.

Headphone Listening

FOR WARTIME CONDITIONS

By R. H. WALLACE

FOR the crowded conditions likely to prevail in many households during wartime, headphones have advantages over the loud speakers if only for the reason that the various noises incidental to searching for distant stations are annoying to others. This article shows how phones may be connected to a receiver not primarily designed with this object in view

IN the earlier days of wireless reception no one thought of using anything but headphones for telephony, since the power then available for sound reproduction was too small for any other means. Phones passed successively through varying stages of popularity, waning gradually in general favour as loud speakers became both cheaper and more efficient. In part their decline was due to the physical disadvantage of being tied to the set, with the additional consideration that a number of people could listen comfortably at the same time to one loud speaker.

There are, even nowadays, not a few circumstances which render headphones of special value, and their usefulness is not confined solely to the enthusiastic amateur. Many people forgo the use of the set on account of the interference which it causes to others in the same room. This is particularly the case with the average household in winter; at the present time, faced with coal rationing, most of us will have to make do with a fire in one room. Again, there is the case of deaf people, who stand especially to gain from headphones. In order to enable a deaf person to follow the average programme in comfort it is necessary to raise the volume to a level which is not only intolerable to those of normal hearing in the room but a source of discord amongst neighbours. In all these cases the use of headphones confers real advantages.

It must not be thought, however, that the indiscriminate connecting of 'phones to the average set is advocated by the writer. There are certain precautions to be observed, more especially with mains-operated sets, and in few cases can this be done without some slight modifications or additions to the set. Further, in most cases the volume on phones is either deafening or scarcely audible at all, according to the type of extension speaker provided. These alterations need not be expensive, and indeed many listeners will have the necessary components, and possibly the 'phones, too, in the junk box.

The chief precaution in respect of safety is against the risk of shock to the wearer, due to the contact of the headband, or other metal parts of the 'phones, with the head. In order to make certain that shock cannot occur it is desirable directly to earth one side of the 'phones, when the voltage at any part of the earpieces cannot well rise above a safe limit. Two methods of isolation are available: either the use of condensers in each lead, or the use of a

transformer of suitable ratio between the output terminals of the set and the 'phones; particularly in AC/DC sets there is a risk that, if this is not done, some leakage of the mains potential may take place across the internal speaker transformer, or other component, while it is not in all cases permissible to earth one speaker terminal — hence the use of two condensers. If the 'phones are thus isolated from the set, then one side of them may be directly earthed; if this is done no risk at all remains, but it must be remembered, however, that the isolating condensers or transformer should be able continually to withstand at least 500 volts.

The problem of matching the particular headphones used to the set is not the usual matter of equalising the impedances, as it is with an extension speaker, since only a fraction of the available acoustic output will be required; in case the 'phones are used without the set speaker being connected it will, however, be necessary to absorb in some manner the surplus energy. It is desirable that the apparent volume from the 'phones should be closely equal to that from the

speaker, partly to avoid undue use of the set volume control, but mainly to permit the use of extensions at the same time. The relative volume naturally varies with the sensitivity of the 'phones and speakers, and the following suggestions depend therefore on these being of average performance; they will be in any case a guide to the approximate values required and a little experiment will soon settle the precise details.

Normally the only readily accessible point in the set to

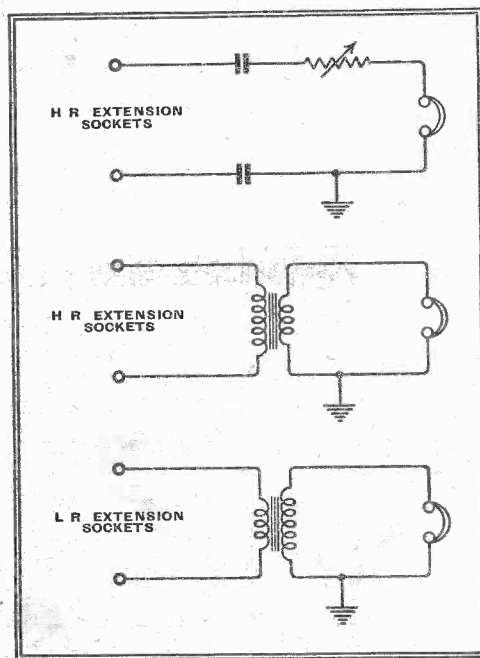
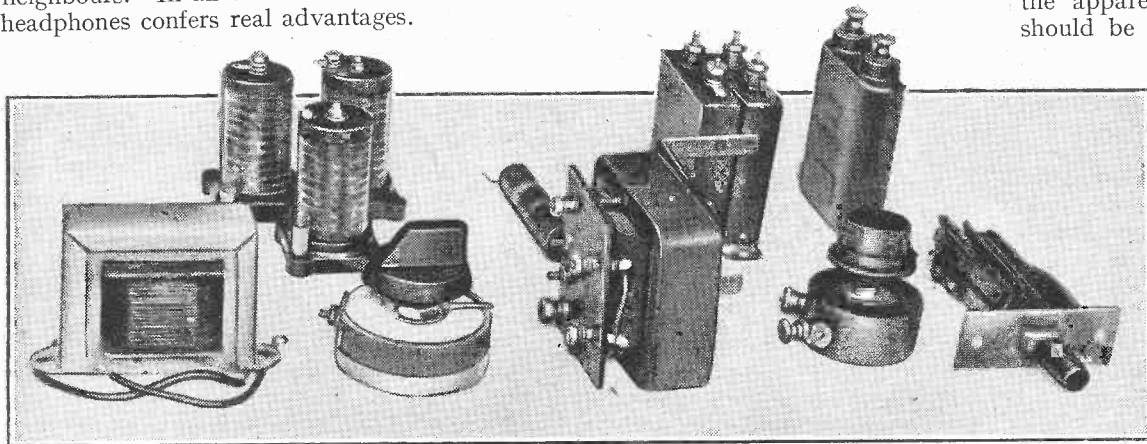

Fig. 1.—Methods by which phones of high resistance may be fed safely from extensions of different characteristics. Condensers and transformers must withstand full mains voltage plus plate voltage in the first two cases and possibly in the third if the components in the set are leaky. The earth connection to the phones is essential.



Group of components suitable for use in phone adaption units and which are to be found in most experimenters' workshops. Iron-cored RF chokes from 0.25 to 0.5 henry, primary of small transformer about 1 henry. Paper condensers should be tested, as old ones are often leaky.

Headphone Listening—

which connection can be made will be the extension speaker sockets. Makers differ considerably in their ideas and any impedance from 2 to 20,000 ohms may be met; the latter, of course, only in the case of battery sets. Where a high-resistance output is provided it will be necessary either to use a step-down transformer, or to put a resistance of considerable value in series with the 'phones, in order to reduce the volume to bearable limits. With 'phones of 4,000 ohms total resistance and an output impedance of 10,000 ohms, such as is the case with the majority of battery pentodes, a ratio of 7/1 will be found to give a volume comparable with that of the set speaker; alternatively a potentiometer of 0.5 megohm may be used following the condensers and in series with the 'phones. These conditions are shown in Fig. 1.

It is probable that most people have a set where the extension impedance required is around 4 ohms. In these cases, provided that the speaker and 'phones are of normal sensitivity, the use of a transformer of about 3/1 ratio will give a suitable volume in 4,000-ohm 'phones. It should be noted that the latter figure is the DC resistance, which is usually stamped on the earpieces, and throughout the present article this is the sense in which specified 'phone resistances are to be understood; the actual impedances vary widely from make to make, with differences in the magnetic circuit, and on this account precise calculations are almost impossible. Where 7.5- or 15-ohm speakers are in

necessary when paralleling in this manner to take special care that the sound fed to each ear is in phase; this will be the case so long as the two terminals marked posi-

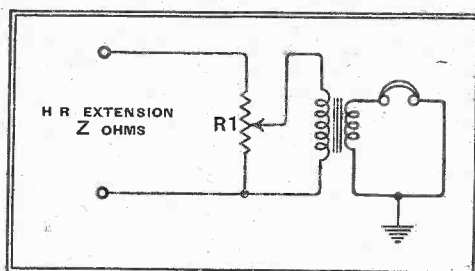

Fig. 3.—Another method, providing greater flexibility, of controlling volume with an HR extension. Z, output impedance in ohms; R1, 2 × Z ohms, 3-watt; step-down trans-

former ratio, $\sqrt{\frac{Z}{200}}$

tive are connected together; an attempt to listen with his connection incorrectly made will soon indicate that something is

this will involve little alteration in the volume of any other speaker in use. Such a value will do no harm to the set even when used alone, since the impedance of this resistance will not rise, as that of the speaker does, at the higher audio frequencies, and thus there will not be any dangerous voltages developed in the output section, even with pentode valves.

Figures 2, 3 and 4 give suitable values (in terms of the output impedance at the extension sockets of the set) for the components; the values suggested will provide a range both above and below the volume of the set speaker, either when used separately or in conjunction with this. The actual figures are not at all critical, and there is no reason why, for example, a transformer of half, or twice, the ratio indicated should not be used, though the range of the volume control may then be curtailed at one extreme or the other. The power-handling capacity of a transformer for this application need not be great, and a midget type will do nicely.

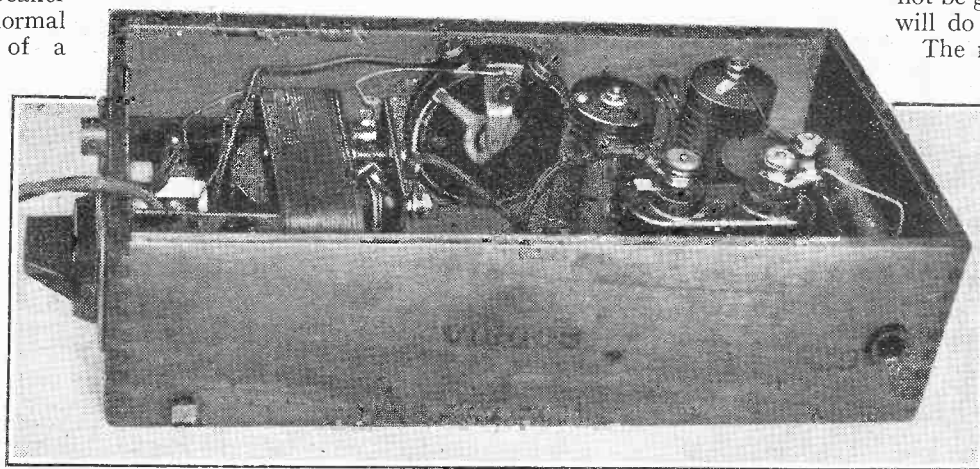

The various components of a phone adaption unit may be mounted in a box; the simpler form of unit, without tone control, occupies very little space.

The normal tone controls of the set will, of course, function equally well for headphone reception; thus there is rarely any need to provide the listener of normal hearing with any additional means of reducing high-note response, since this control is almost always incorporated in the set; further, the frequency response of ordinary 'phones not being very wide, any trans-

former of suitable ratio may be employed, and the quality of reproduction will satisfy most people. In any case, since there is no initial polarisation of the core by DC component, the quality obtainable will be better than would normally obtain. Where it is felt that some correction is needed, it is comparatively easy to provide this by using a transformer of somewhat higher step-up, in the case of low resist-

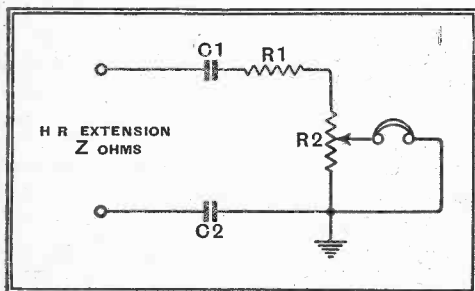

Fig. 2.—Simple circuit giving control of volume with a high-resistance extension output. Z, extension impedance in ohms; C1, C2, 1 mfd., 500 volts working; R1, 1.5 × Z ohms, 2-watt; R2, 0.5 × Z ohms, 1-watt. In this diagram and Figs. 3 and 4 the phone resistance is assumed to be 4,000 ohms.

use then a ratio of unity will probably suit, but it may in the former case be preferable to reconnect the earpieces in parallel, instead of the more usual series connection, thus reducing the resistance from 4,000 to 1,000 ohms. It is

wrong; the type of distortion resulting is difficult to describe but is definitely unpleasant.

Artificial Loading

Throughout the foregoing it has been assumed that the set speaker is also connected, or else some extension, to maintain the load on the output valve. Where 'phones are used as an alternative to the speaker, as will frequently be the case, then it is necessary to ensure that the primary or secondary of the 'phone transformer is shunted by a resistance of suitable value, and since in the latter case the transformer will itself have to handle the full output of the set, it is naturally preferable to place it across the primary. A resistance used for this purpose must, of course, be capable of dissipating safely the peak audio output of the set, which will normally be from 3 to 5 watts; the value is not critical and it is convenient to use a potentiometer, since in this way the voltage fed to the 'phones may be regulated.

The value of the loading resistance will naturally depend on the output impedance of the set and a suitable value is twice the nominal extension value, since

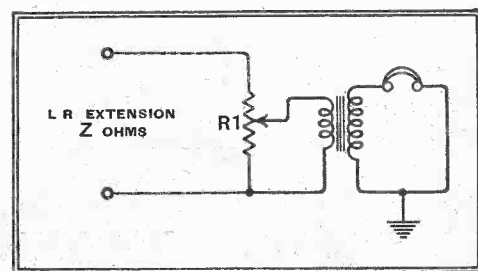

Fig. 4.—Volume control for use with low-impedance outputs. Z, impedance in ohms; R1, 2 × Z ohms, 3-watt; step-up trans-

former ratio, $\sqrt{\frac{200}{Z}}$

an L R extensions, or of lower step-down ratio in the case of high resistance, using a reactive or inductive network between

Headphone Listening—

the secondary and the 'phones. One method of doing this is indicated in Fig. 5, the values being given a range covering very considerable modification of response; the higher values of inductance and the lowest of capacity are more appropriate to 4,000-ohm 'phones. There are, of course, other methods of achieving the same results; one may use chokes and condensers in resonant or non-resonant circuits. An arrangement of this nature is shown, with suitable values, in Fig. 6, though those suggested in Fig. 5 are preferred by the writer for the present purpose. With the inductive or reactive

potentiometer the total impedance reflected across the primary of the transformer tends to fall at unwanted frequencies; this in turn increases the proportion of the total output taken and offsets to some extent the compensation secured. In many cases also a good deal of the power is wasted even at frequencies of maximum response. On the other hand, with the series arrangements recommended, the reflected impedance rises at those parts of the scale where one most wants to reduce the proportion taken by the 'phones, while the full volume is available at other frequencies and therefore the apparent volume does not change greatly at different settings of the control.

When using the suggested tone-control circuits it will usually be found preferable to parallel the earpieces, since the effect of the inductive impedances will be

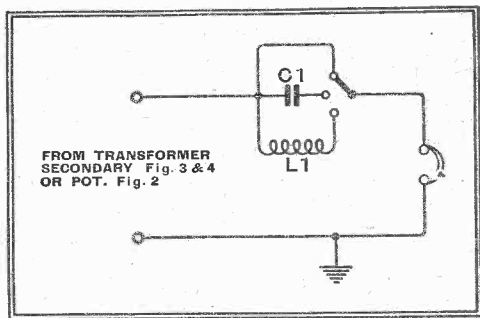

Fig. 5.—Provision of top or bass lift in the circuits previously dealt with. C1, 0.005 to 0.1 mfd.; L1, 0.3 to 10 henrys. Phones 1,000 or 4,000 ohms.

thereby enhanced and a greater compensation result. For instance, if 4,000-ohm 'phones are used in the circuit of Fig. 5, an inductance of from 2 to 15 henrys may be required. This is rather outside the range of most tone-control chokes, though too low to permit the use of an ordinary AF type. If a 'phone resistance of 1,000

ohms is considered, the required inductance becomes one-quarter of that above for the same correction, and an air-cored coil will give this, or the secondary of an output transformer may often be found suitable. An RF choke of the superhet type is also suitable where values between

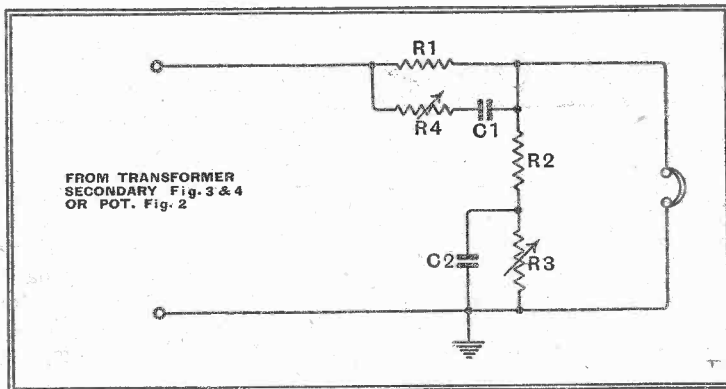

Fig. 6.—Obtaining tone control by means of a reactive potentiometer. Phones of 1,000 or 4,000 ohms may be used, the lower values of capacity given being appropriate to the latter. R1, 10,000 ohms, 1/2-watt; R2, 1,000 ohms, 1/2-watt; R3, R4, 10,000 ohms; C1, C2, 0.05 to 0.25 mfd.

0.3 and 0.5 henry are required. Suitable components may be found among the midget output transformers of various makers, where the primary has an inductance between 0.5 and 2 henrys, since in this case there is no objection to the use of an ungapped core, there being no DC component.

It should be remembered that with ordinary headphones it is not worth while making any attempt to increase the response much above 7,000 cycles, since the response at these frequencies will be in any case small; also an increase of the extreme bass will in some cases cause rattling of the diaphragm on the pole-pieces if an attempt is made to increase the power too much.

It is convenient, in many cases, to assemble the few components needed in a small box, which may be connected to the set by sufficient wire to enable it to be placed upon the chair arm; a jack may be provided for the insertion of the 'phones when desired. If this is done then it is quite easy to use the unit at will in any room fitted with extension wiring and the necessity of adjusting the volume at the set is avoided. When, however, DX listening is frequently indulged in it will probably be more convenient to incorporate the necessary components within the set, providing a suitable switch to cut out either the 'phones or set speaker as required.

The writer can assure those who care to undertake this adaptation that it will well repay them for the small outlay involved, giving at the same time much greater flexibility in reception and removing a frequent source of discord in the home. A subsequent article will deal with the modifications necessary to increase the volume in the 'phones for use by the deaf and will give particulars of the design and construction of a versatile unit especially suited to these requirements but also convenient for the ordinary listener.

Henry Farrad's

PROBLEM CORNER

No. 38.—Where Did the Volts Come From?

An extract from Henry Farrad's correspondence, published to give readers an opportunity of testing their own powers of deduction:—

"High Rise,"
Shortham.

Dear Henry,

I don't usually worry very much about shocks, even of the 400-volt order, but I have just had one that has given me something to think about. And it wasn't off a television set, either. Just an ordinary "beam tube" amplifier running off 375-400 volts HT. I had the thing on and working properly, and took hold of an earth lead to connect to it; my other hand, I suppose, must have been resting on the chassis. The next thing I was in the middle of the room wondering who had kicked my chest.

The power unit is a perfectly standard full-wave valve rectifier circuit (see sketch),

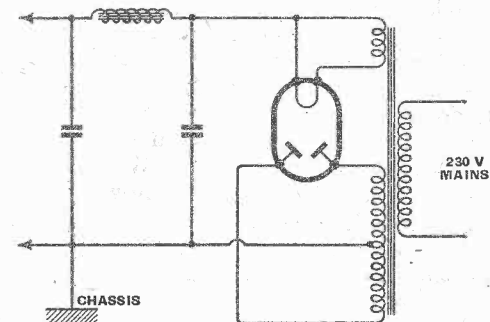

with a 425-0-425-volt transformer running off 230-volt mains, being one that I picked up second-hand. The output voltage is correct, however, for I measured it. And after my hands had stopped shaking I measured the DC volts between chassis and earth—440. But it felt a great deal more than that. What do you think it might be? I am finding this weather too hot to think!

Yours ever,
Hugh Vaulter.

P.S.—There was no earth connection, intentional or otherwise, to the amplifier or power unit.

Precisely how did the apparatus cause such a dangerous voltage, and how high might it be? Think it over, and then turn to p. 274 to see if your solution agrees with Henry Farrad's.

Pilot "Twin-Miracle" Portable

ON page 198 of the August 31st issue this receiver, which operates from AC/DC mains or dry batteries and has an automatic relay for changing over to batteries in the event of failure of the mains, was inadvertently ascribed to another firm.

The makers are, of course, Pilot Radio, Ltd., 31-33, Park Royal Road, London, N.W.10, and the price of the "Twin-Miracle" receiver, including batteries, is 9½ gns.

Power from the Wind

ITS USES FOR ACCUMULATOR CHARGING

By A. W. BEATT

WINDMILL generating plants are an interesting source of power for battery charging, and are becoming increasingly popular with the introduction of cheap and reliable plants. Wind power should be of particular interest to owners of radio sets living in remote places far from charging facilities, and also in less remote districts where there is no mains supply available, when a local generating set will save the trouble of transporting batteries to the charging station. Small wind-driven charging installations are now widely used in America.

Wind is free; it blows in most places on most days of the year. Even when it appears calm at ground level, a useful breeze may often be found at an elevation of 40 to 80 feet above ground, as one will find on ascending a building such as a church spire, which stands clear of other buildings.

With wind-power, as with water-power, although the up-keep costs are low, the original capital cost of plant can be so high as to offset the advantages of absence of fuel costs. With mass production methods, however, wind-power is becoming a practical proposition financially, at any rate for lighting and battery charging purposes.

In the old and more leisurely days when windmills dotted the countryside, work could and did wait on the vagaries of the wind. The advent of steam and oil, which were independent of the weather, deflected business from the windmills, and they became mainly picturesque objects of interest, but of limited practical use. Electrical storage batteries have, however, altered matters. One cannot store wind, but electrical energy generated by the wind may be stored to tide over calm periods, and the oldest source of power becomes one of the latest.

A wind-wheel may be of one of a number of different types. There is a horizontal type of wheel with cup-shaped vanes on a vertical shaft, which is slow and rather inefficient but does not require to be turned into the wind. There is also a vertical type of wheel on a horizontal shaft, which is usually kept turned into the wind by means of a tail, but is sometimes mounted so that it works on the lee side of the supporting tower, and acts as its own tail to keep it turned to the wind. The latter wheels, i.e., vertical on a hori-

IN cases where no mains supply is available, the use of a wind-driven generator for accumulator charging offers interesting possibilities — always provided, of course, that the locality is suitable.

zontal shaft, may be of a high-speed or a low-speed type, depending on the ratio of the speed of the tips of the blades to the wind-speed. There is a slow-speed type of "American" wheel with a large number of vanes and a tip-speed to wind-speed ratio between 1 and 2, and a high-speed type of wheel with a small number of blades, usually two to four, with a

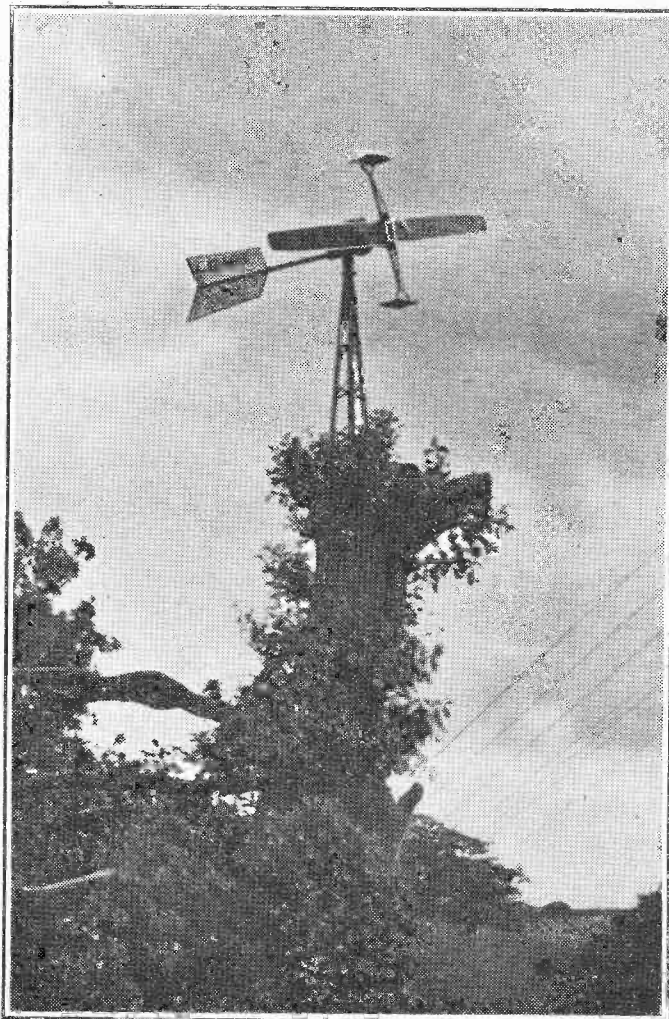

32-volt "Wincharger" mounted on pollard tree stump.

tip-speed to wind-speed ratio of 3 to 6.

The multi-bladed wheel is capable of starting against heavy loads, and this and its slow speed makes it suitable for work such as pumping. When used to drive

a dynamo considerable gearing is necessary. Also, the large sail area offers considerable resistance to sudden gusts of wind, and a comparatively strong tower is required.

The high-speed wheel, usually the type with two blades, is perhaps the most popular for small charging plants. The blades are aerofoil-section, either carved from solid wood, as is usual in the smaller plants, or of fabric stretched over a frame. For manufacturing purposes something of a compromise is necessary in the design of the wind-wheel. The most efficient wheel is not necessarily the cheapest to manufacture, and usually a larger wheel of a less specialised design cheaper to produce is employed, instead of a smaller and theoretically more efficient wheel. The high-speed wheel is not good at starting under load, but for battery charging this makes little difference, since the load is not applied by the automatic battery cut-out until the wheel has run up to charging speed. The high-speed wheel, on account of the small area of the blades, offers little resistance to sudden gusts of wind, and a comparatively light tower is sufficient.

A speed governor is necessary owing to the variability of winds, and this is usually designed to limit the speed of the wheel in wind-speeds over 20-25 m.p.h. In the smaller plants a governing action is obtained simply by offsetting the wheel slightly on the turntable, so that the wheel tends to turn out of the wind when the latter increases in velocity. In the larger plants, made by the Wincharger Corporation, of America, a pair of metal vanes mounted on the wind-wheel tend to turn against the direction of rotation and offer increased wind resistance as the speed of the wheel increases. The weight of the latter governor acts as a fly-wheel tending to maintain a steady speed in gusty winds.

A third-brush generator is usually employed to give additional control of the charging current. An automatic cut-out is, of course, necessary between the dynamo and battery. The dynamo is usually mounted on the turntable with the wind-wheel, and may be direct or gear driven, the leads being taken through slip rings below the turntable. Ball bearings packed with grease

Power from the Wind—

require only occasional attention, and when overhaul or inspection is necessary provision is made to stop the wind-wheel either by means of a brake on the shaft, or by folding back the tail to bring the wheel out of the wind.

The wind-wheel should be mounted in as clear a position as possible, away from obstructions such as house and trees, which may deflect the wind from a considerable area around and even above them. The wheel may be mounted on a short tower on the roof of a house or barn, or even on a trimmed tree. Lattice sectional masts are perhaps best of all; they are obtainable in 18ft. sections which may be bolted together to obtain a stayed mast up to 80 feet or more in height.

Suitable Conditions

There are a considerable number of wind-driven charging plants in use in Ireland. The majority are, perhaps, in the coastal districts within a few miles of the sea. Several plants known to the writer are, however, giving equally satisfactory results in inland districts both hilly and flat, including one or two in what would appear to be unsuitable localities screened by hills. Where adverse conditions are met it is often possible to overcome them by adding additional sections of tower in order to increase the height of the wind-wheel. Choice of position in relation to prevailing winds is also sometimes important. Incidentally, 18ft. sections of lattice tower are obtainable at £4 10s. A 12-volt 300-watt plant with 6ft. wind-wheel and stub tower complete except for the battery works out at about £16 16s. A 32-volt 650-watt plant with 10ft. blades costs about £36 15s.

The 12-volt 300-watt plant is capable of supplying a radio receiver as well as providing some lighting. The radio set may be a vibrator type receiver, the supply for which is tapped off the main battery. HT supply might alternatively be from a rotary convertor, or from 10-volt HT accumulator blocks charged in parallel and discharged in series.

Wind-power generating plants give the amateur constructor plenty of scope. An old car dynamo with other scrap car parts makes the basis of a number of plants constructed by enterprising mechanics. With high speed wind-wheels up to five or six feet in diameter it is possible to drive a suitable dynamo direct, while with larger wheels a step-up ratio of 3-1 may be required. Much depends on the design of the wheel.

The kinetic energy in the wind may be worked out from the empirical formula: horse-power = $0.0000226AV^3$ where A is the area in square feet exposed to the wind and V is the wind-speed in feet per second. The efficiency of a wind-wheel may be 25 to 40 per cent. The maximum possible efficiency has been calculated as 59.26 per cent. Much of the energy is required to carry the wind away from the lee of the wheel. Annual hours of wind above 8 m.p.h. in England and Scotland

might be expected to range from about 3,800 to 6,700.

Further information on the subject of windmills is to be found in "Windmills for

the Generation of Electricity," published by the Institute for Research in Agricultural Engineering, University of Oxford, price one shilling.

Above Three Megacycles

CONDITIONS FOR SHORT-WAVE NEWS-GATHERING

SHORT-WAVE reception remained excellent during the period under review, except possibly during the early afternoons, when on occasion higher frequencies than 17 Mc/s have been indicated for most long-distance broadcasts.

On Thursday evening, September 7th, WGEA on 15.33 Mc/s was noted as not too strong at 6.20 p.m. G.M.T., but it improved rapidly. Both W2XE and WNBI were strong on the 17-Mc/s band. Talking about WGEA, the General Electric engineers at Schenectady have developed a number of very large demountable triode valves of the continuously evacuated type for use at the 100-kW sister station WGE0. At some of the B.B.C. stations very large demountable screengrid valves are in use, but these new American triodes are the largest of their kind in the world.

At 11.40 a.m. G.M.T. on September 8th neither WNBI nor W2XE could be heard on 17 Mc/s, but GSG and GSV (B.B.C. Overseas) on the same band were very strong signals. By noon, a 13-metre U.S. station could be heard which turned out to be WPIT, Pittsburg, radiating a programme from London with N.B.C.'s London representative speaking. The 16-metre band was still dead, W2XE and WNBI being inaudible. Actually nothing was heard of the two 17 Mc/s Americans until 1.10 p.m., at which time they had risen out of the noise to be good signals, but they weakened again later.

The position was similar at 2.40 p.m. G.M.T., but at this time WNBI was superior to W2XE during the former's English news. The noise level on WNBI was about -10 db., improving to -30 db. by 3.45 p.m. The English Hour on WNBI at 4 p.m. was, however, only 50 per cent. intelligible, since the signal deteriorated badly to zero noise level. The C.B.S. transmitter was somewhat better than WNBI at 6.10 p.m., due to a higher modulation level on W2XE, and WGEA had become a useful signal but with high noise. Some strong jamming by an unidentified broadcaster was noted on W2XE at 6.40 p.m. G.M.T. onwards.

Shorter Wavelengths Best

Conditions were definitely in favour of the high frequencies on Saturday morning, September 9th, and it was noted that, contrary to experience, Java PMA on 17 Mc/s (using multiplex morse and phone) was very strong at 10.30 a.m. It is worth recalling that on Thursday, September 7th, PMB on 20 Mc/s was considerably stronger than PMA until well into the afternoon. By Saturday, therefore, we may assume that the maximum ionisation period had passed, but nevertheless conditions were very good from 13 metres upwards.

Both WNBI and W2XE came up strongly at noon G.M.T., and W2XE opened with a three-cornered broadcast from Berlin, London and Washington. This station was very strong indeed at 1.25 p.m.

The English Hour from WNBI on 17.78 Mc/s was strong and good on Saturday afternoon at 4 p.m., but it was noteworthy that 80 per cent. of the news came from German sources. It is a pity that the American international broadcasters cannot be supplied with more English news; they seem ready enough to use it.

Conditions from the U.S. stations remained good on Sunday, September 10th, and amongst other signals heard was the half-wave of CSW2 Lisbon on 22.08 Mc/s; the fundamental was a strong signal.

The Belgian station ORK on 10.33 Mc/s was a strong signal, too, at about the same time (6.50 p.m. G.M.T.), giving a news bulletin in French.

Readers will recall that in last week's notes I suggested that conditions were moving towards the VHF end of the spectrum; this prophecy seems to have been justified, as at 7 a.m. G.M.T. on September 14th snatches of programme were audible from quite a number of American high-fidelity 11-metre broadcasters. Despite the lateness of the hour, the 13-metre band was still "live," and there was considerable morse activity from 11 metres upwards.

Since then there has been little change, up to the time of writing, in reception of the stations mentioned, and many others have been available, too, as listeners can no doubt testify. I hope to keep listeners informed, however, of any important developments that may occur in the future.

"ETHACOMBER."

CP "Filtanoise"

WHERE mains-borne interference is troublesome and the filtering arrangements incorporated in the receiver are not adequate to deal with it, this component will help in reducing the background noise.

The circuit includes chokes, in addition to the usual capacity filter, and the earth connection is brought out to a terminal on the side of the cylindrical container. The unit is $4\frac{1}{2}$ inches long, and $1\frac{1}{2}$ inches in diameter, and it is fitted with standard 5 amp. two-pin plugs and sockets for insertion between the power point and the mains plug of the set.

The price is 9s. 6d., and the makers are The Cooper Perry Manufacturing Co., Ltd., 26, Charlotte Street, London, W.1.

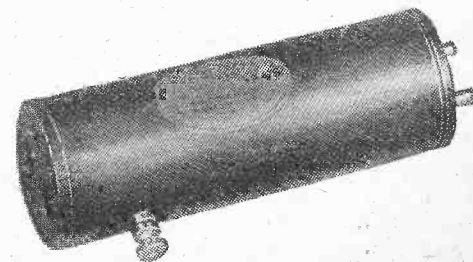

Designed for the suppression of mains-borne interference, the CP "Filtanoise" is readily fitted in the mains leads of the set

Grid - blocking in RC Amplifiers

ITS CAUSE AND CURE

WHILE momentary overloading may cause little trouble with transformer coupling it is often serious with resistance coupling since the grid current charges up the grid condenser. In this article a way of reducing the effect is described

MOST people agree that the resistance-coupled amplifier is superior to others from the point of view of quality. It does, however, suffer from one defect—its operation is badly affected by grid current. Resistance coupling is, of course, only used for Class A amplification, with which there should be no grid current, but one cannot always guard against momentary signal peaks which may overload the amplifier and drive one or more valves into the grid current region of their characteristics.

Such a peak inevitably leads to distortion with all amplifiers, but with resistance coupling it may paralyse the amplifier for a short period following it. This phenomenon is known as grid blocking.

What happens is easily seen with reference to Fig. 1. Suppose that there is applied to the grid a positive voltage peak of amplitude exceeding the

reference is bad. The writer has met cases where the first AF stage was almost continuously blocked by the peaks of local interference.

Assuming the stage of Fig. 1 to be fed from a low impedance circuit, the time taken for the condenser to discharge depends on the product CR whereas the time taken for it to charge depends on CR_g , where R_g is the effective grid-cathode resistance of the valve. In general, the positive peak is of quite short duration and then the voltage to which the condenser is charged depends on CR_g . Obviously it is desirable that CR_g should be large and CR small, which means that R_g should be larger than R .

In practice, however, the reverse is the case; R is usually some $0.25-2.0M\Omega$ and R_g is only a few thousand ohms when the grid is positive. Matters are rather better when the input circuit is not of low impedance, for then the impedance to the left of the input terminals of Fig. 1 comes in series with both charge and discharge paths. If this impedance be regarded as added to both R and R_g , then although both the charge and discharge time-constants become greater, their ratio has been increased, which is all to the good.

The Grid-stopper

In order still further to improve matters it has been suggested¹ that the charging time-constant be further increased by inserting a resistance R_1 in series with the grid of the valve as shown in Fig. 2. This is the familiar grid-stopper, and the charging time-constant becomes $C(R_1 + R_g)$ while the discharging time constant remains at CR . If R_1 is made large, much more favourable operating conditions are secured. For instance, if $R = R_1$, the two time-constants become nearly equal. For peaks of short duration the condenser is

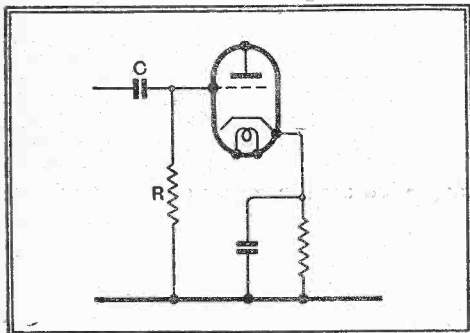
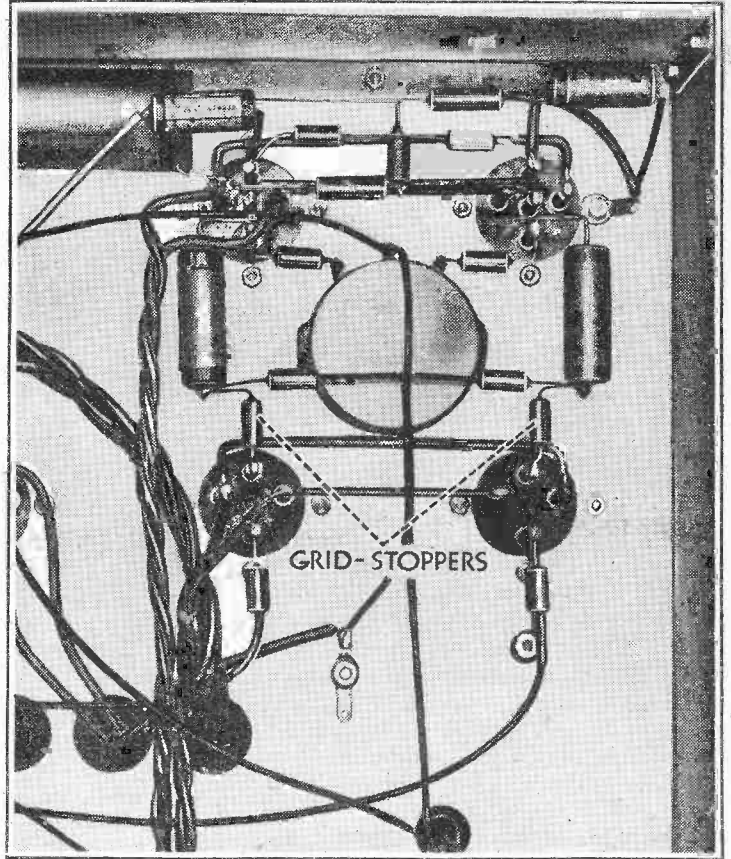

Fig. 1.—This diagram shows the conventional RC coupling.

bias voltage, so that the grid is driven positive. Grid current flows and charges the condenser C negatively. After the peak voltage has passed, this charge on C remains and leaks away slowly through R . Until C has discharged, therefore, the valve is operating with excessive grid bias and distortion is likely to occur. In extreme cases, when the positive signal peak is very large, the valve may for a time be driven beyond anode current cut-off.

In the case of an output stage, this last effect is very rare. Grid current usually occurs through momentary overloading on a loud passage of music, and the overloading is quite small. Complete blocking is much more likely to occur in an early stage when the amplifier follows a sensitive receiver used in a district where local inter-

fered to a much lower voltage. This is itself less harmful to the performance, but in addition what charge there is falls to a negligible amount in less time just because it is smaller to start with. Blocking is not only less severe but lasts for a shorter time. There is, of course, little improvement in the case of peaks of long duration for then the condenser still has time to charge up fully.

The use of too large a value for R_1 must be avoided, however, for the presence of this resistance in conjunction with the working input capacity of the valve will cause a drop in response at high frequencies. This capacity is shown dotted

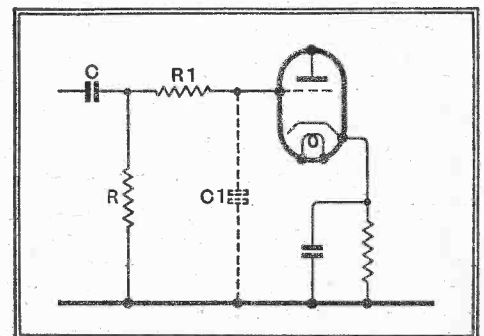

Fig. 2.—The use of a grid stopper is shown here; it must not be too high on account of the input capacity of the valve.

in Fig. 2, and is approximately equal to the static grid-cathode capacity of the valve plus $(1+A)$ times the grid-anode capacity, where A is the voltage ampli-

¹ Electronics, April, 1937.

Grid-blocking in RC Amplifiers—

fication of the stage, not the amplification factor of the valve.

For a drop of not more than 1 db. at 10,000 c/s, the product CR should not exceed $8.2 \mu\text{F}\text{-}\Omega$. A typical triode may give a gain of 20 times with grid-cathode and grid-anode capacities of $5 \mu\mu\text{F}$ and $4 \mu\mu\text{F}$ respectively. It will thus have an effective input capacity CR of $89 \mu\mu\text{F}$; consequently, R should not exceed $92,500\Omega$, or say, 100,000 ohms. In the case of a screened tetrode or pentode amplifier CR is much lower and may be less than $10 \mu\mu\text{F}$. Values of R up to $1 \text{M}\Omega$ may then be permissible. This is all to the good, because such valves usually have a shorter grid base than triodes and so are more liable to grid blocking.

It should not be forgotten that if the valve makers place a limit to the total grid-

circuit resistance, it will be necessary to reduce R when inserting R_1 . Thus some valves often have a limit of $2 \text{M}\Omega$, and this is a common value for R in Fig. 1. If R_1 is made $0.1 \text{M}\Omega$, the increase in total resistance is quite small—5 per cent.—and R need not be changed. On the other hand, if R_1 is made $1 \text{M}\Omega$, then R must be reduced to $1 \text{M}\Omega$ to keep within the limit.

In no case should the capacity of C be larger than is necessary to obtain the required bass response. A value for CR of $0.02\text{-}0.025 \mu\text{F}\text{-}\text{M}\Omega$ is large enough for the highest quality in normal circumstances and should not be exceeded. This means a $0.1\text{-}\mu\text{F}$ condenser with a $0.25\text{-}\text{M}\Omega$ grid leak, or a $0.01\text{-}\mu\text{F}$ condenser with a $2\text{-}\text{M}\Omega$ grid leak and so on. Often smaller values can be used without a noticeable loss of bass.

HENRY FARRAD'S SOLUTION

(See page 270)

THE highest voltage that the apparatus could set up between chassis and earth under the condition described is nearly 900 volts peak, which would happen if the rectifier heater winding became "shorted" to

inter-winding breakdown as supposed, the result is C, which has a peak value of about 875. The DC reading is still 440, however, for only AC has been added.

If the live side of the mains were shorted

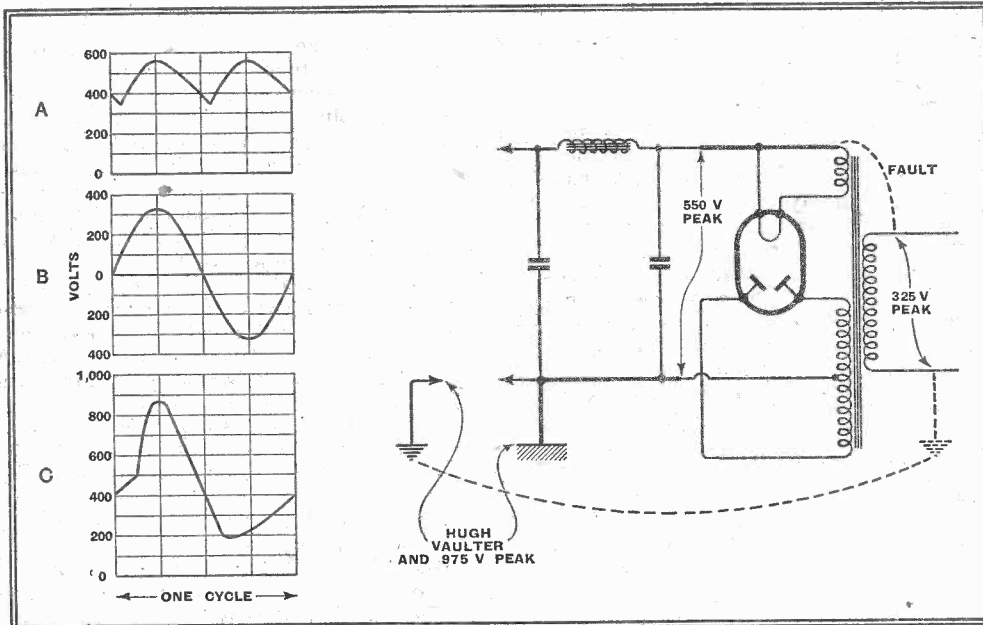

The severity of the shock received by Hugh Vaulter was due to a failure of insulation between primary and secondary of the mains transformer.

the live end of the primary. If it were shorted to any other part the peak voltage would be less, being below 600 if the short were to the earthed side of the mains. It is evident that such a short-circuit does exist, because if there were no earth connection at all the apparatus could not set up a continuous voltage between itself and earth; so, as no earth existed to the apparatus itself, the only way it could be introduced is via the mains, one side of which normally is earthed. The voltage between chassis and rectifier heater would be as shown at A, and a DC voltmeter would read about 440 volts on this, as stated. The peak value would be the transformer secondary peak ($\sqrt{2} \times 425$, or 600 volts) less perhaps 50 volts drop in the rectifier. The voltage across the primary is shown at B (325 volts peak). If the two are added, due to the

to the end of the HT secondary in phase with it, a slightly higher peak voltage still—925—would result, but, being purely AC it would not show on a DC voltmeter. The only possible fault, therefore, is the one shown.

The hot weather is likely to have been a contributory cause of the severity of the shock, because of the moistness of the skin. In fact, Mr. Vaulter is lucky to have escaped alive; an American, Phil Murray, was killed by exactly this type of fault, although he was not even holding an earth lead, but only standing on a wet floor, and the mains voltage would have been only 110.

The two morals are: be cautious about using transformers of doubtful origin, and earth the apparatus *before* switching it on or even plugging it into the mains-outlet socket.

Books Reviewed

Electrolytic Condensers (2nd edition), by Philip R. Coursey, B.Sc., M.I.E.E. Pp. 190+xii; 125 illustrations. Chapman and Hall, Ltd., 11, Henrietta Street, London, W.C.2. Price 10s. 6d.

UNHAPPY experiences with electrolytic condensers of early vintage have left behind prejudices that still linger in many minds. While some of the troubles in the first few years of their application were undoubtedly the result of inexperience in manufacture, any unsatisfactory performance at the present day is much more likely to be due to the designer who applies them failing to understand the respective advantages and limitations of the various types.

Mr. Coursey's book, now brought up to date by a revised edition, explains clearly the conditions for successful use; showing, for example, how a type of electrolytic condenser that would fail very quickly under certain conditions is capable of exhibiting no appreciable deterioration after three years of continuous life test if used within its proper rating. If set-makers would take the condenser manufacturers fully into their confidence regarding the working conditions, and allow the fraction of extra money that represents the difference between a risk and a certainty, there would be little complaint about the performance of electrolytic condensers.

The characteristics of different types, including the latest surge-proof, etched-foil and multiple-wet varieties, are displayed by excellently produced curve sheets. In view of such minor characteristics as the influence of ripple amplitude on apparent capacity being included, one would like to have more definite data on the important relationship of the magnitude of ripple current to life. Also, the practical value of some of the data concerning operating voltage is lost because the rated voltages of the condensers in question are not stated (e.g., Fig. 94).

With regard to the testing of electrolytic condensers, to which a chapter is devoted, it is not clear why the connecting of the polarising battery in series with the AC test source is rejected in some arrangements because "damage to the battery may result," and advocated in others (including the final and apparently preferred method). Among the methods of testing, a place might have been found for reference to the popular and convenient "tuning indicator" bridge, in which the provision of polarising voltage does not appear to be essential for capacity measurement well within the range of accuracy required.

A minor irritation is the consistent use of the redundant form "DC current" (i.e., direct current current); and there are a few errors, but none likely to mislead were noticed.

These are minor criticisms and suggestions: the book can be confidently recommended to all designers, service engineers and others concerned with electrolytic condensers. A special word of praise is due to the unusually comprehensive index.

M. G. S.

Two-Stroke Motor Cycles and Autocycles, by the Staff of *The Motor Cycle*. Pp. 178 and xix. Published by Iliffe and Sons Ltd., Dorset House, Stamford Street, London, S.E.1.

THIS is the seventh edition of this well-known handbook, and contains several chapters devoted to the popular motorised bicycle.

Random Radiations

By "DIALLIST"

War and Wireless Progress

WHAT will be the effect of the present spot of bother on the development of wireless? One can only make surmises, of course; but it's interesting to do so. During the Great War wireless was a lot younger and broadcasting was still a good many years away. Nearly all of the countries famed for electrical progress were directly involved. There were developments, but they concerned only the signalling and communications side of radio. The style of amateurs was cramped during the war and for two or three years after it was over by the restrictions imposed here. But progress was made, particularly in the matter of valves. I think I'm right in saying that the old "R" was a valve designed in the first instance for war purposes. Certainly the "C" and "D" valves—first of the "test-tube" type—were, for they were developed for the Air Force. Then there were the early Admiralty valves. Do you remember them? The filament leads were brought over the outside of the bulb to a miniature screw cap (like that of flash-lamp bulbs) and the plate and grid leads were just loose wires intended for soldering or connection to screw terminals. Progress in other directions was concerned largely with endeavours to obtain greater and greater selectivity by means of tuned circuits and to increase sensitivity by making the best use of regeneration on the one hand and of delicate headphones on the other. The Brown Type A phones—I still have a fine pair—were war babies, unless my memory is at fault.

Changed Conditions

In the present war conditions are very different. Broadcasting has been in being for some seventeen years and has developed so far that the wireless set has become a necessity rather than a luxury in the home. Owing to the demand for news, the war is likely to increase the sales of receiving sets; and the short waves have so much to offer that one foresees a call for something that is a better performer below 100 metres than the average small "all-wave" set. The United States is not involved directly and progress can continue unhampered there. Here it is likely to be handicapped, so far as broadcast receivers are concerned, by the demands made on designing and research departments by the various fighting and defence services. But there will be progress, for these services are always demanding better and better performance, and when we settle down again to peaceful conditions we shall benefit by the discoveries that have been made. Then there are the short and ultra-short waves, in the transmission and reception of which progress is certain. Unfortunately, the amateurs, from whom so much has come in the past, will again be handicapped severely. Many have joined up in one capacity or another. Those who remain in civil life will have their activities greatly restricted. The war is a calamity, but one small consolation for us wireless folk is that it may lead to progress, since vast amounts of money are now available for research and development in so many countries. The pity of it is that this work must be done mainly with warlike ends in view.

The Exhibition in Retrospect

LOOKING back at the Radiolympia of 1939 now that its has passed into history one can view it in its proper perspective. The impression left with me is that, though the Exhibition itself was run mainly on the right lines, the publicity in connection with it was conducted largely on the wrong ones. It was, after all, primarily a radio exhibition, intended to let the public see the newest things in wireless sets, television receivers, components and so on. And had Radiolympia's run not coincided with the days of crisis through which we passed whilst our hopes of peace were being shattered one by one, I believe that the attendance of folk genuinely interested in wireless could have been brought up to imposing figures by good publicity, stressing the purely radio side of it. As it was, much—far too much—of what one read in the lay papers or saw on the posters was devoted to the fun and games aspect. A great pity, for it was quite unnecessary. One excellent and sure way of attracting the man in the street to a wireless exhibition would be to advertise a bureau where he could obtain free expert advice about his radio troubles and perplexities. I don't think that manufacturers in general realise how difficult it is for the ordinary listener nowadays to obtain such help. His only hope is the expert friend, if he is lucky enough to have one. Many of the lay papers used to assist their readers by answering wireless queries; very few of them do so now. Hence, unless a listener reads *The Wireless World* or has a friend who knows the ropes, he can find out very little indeed. The average listener has, as I know from experience, many perplexities that he would like cleared up, and he would jump at the chance of being able to get his questions answered, were it offered at Exhibition time.

Wireless Show for Wireless Folk

Have we seen the last Radio Exhibition? Will there be others to follow the long series up to 1939, or won't there? Each year for some time now questions on these lines have been asked; only a couple of years ago there were many who thought that there would be no more Radiolympias. Almost certainly there will be no kind of show, should the war still be on next August; we can regard the Exhibition as in abeyance "for the duration." But I see no reason why the show shouldn't be revived when piping times of peace return; in fact, I see every reason why it should, though not perhaps on the

lines of recent years. There will always be a good number of folk who are interested in wireless for its own sake. Add to these the far greater number of "half-and-halfers," who are keen on the entertainment that broadcasting provides, but have a certain amount of technical knowledge and like to keep abreast of discoveries and developments, and you have a useful potential attendance for a smallish serious show. And that's what I think it may come to in future years, a smallish show with no fun fair—just pure brass tacks. Something on these lines was to have been staged this year by the R.S.G.B. for certain firms which didn't exhibit at Olympia. It would have been a success, I feel sure. It wouldn't have drawn huge crowds; but those who attended would have been attracted by wireless itself and not by the glamour girls and the crooners. A wireless show for wireless folk is my forecast for the future.

No Juice

CAN you imagine a more tantalising position just now than to have a perfectly good mains-driven short-wave receiver with you and to be unable to use it because no suitable current is available? That's how I've been fixed lately. In the village where I'm billeted there are no mains. The house wherein I sleep has its own plant; but, alas! it's 50 volts DC. And 50 volts DC is also the supply at the scene of my present activities. There's a battery set available, but it is of little use on the short waves. And so here am I, a short-wave enthusiast, knowing that there is more enlightenment to be found on the short waves than ever before and unable to do anything about it. If ever I'm asked to take part in another war, I think I shall refuse to play unless they provide me with at least 200 volts AC. Talking of short waves, I couldn't help thinking, as I sat garbed in my "battle bowler" the other evening, what tuning one of the old straight short-wave sets would have been like if one had been wearing a tin hat. Hand capacity and body capacity were bad enough when one was unarmoured in the old days. What would have happened had one moved a head covered with a soup-plate thing made of sheet steel and weighing several pounds? I only wish I could try it, for even a funny old set with extension handles to its variable condensers would bring in some of the short-wave stations that I so badly want to hear.

COMBINED VERTICAL-LATERAL PICK-UP.

An important innovation by Western Electric in America is this playback unit (type 1300A) with its entirely new 9A pick-up, fitted with a diamond-pointed stylus, capable of reproducing hill-and-dale cut discs as well as ordinary lateral-cut records. The overall frequency response of this reproducer set extends beyond 10,000 c/s. Two vertical and five lateral reproducing characteristics can be selected by a switch.

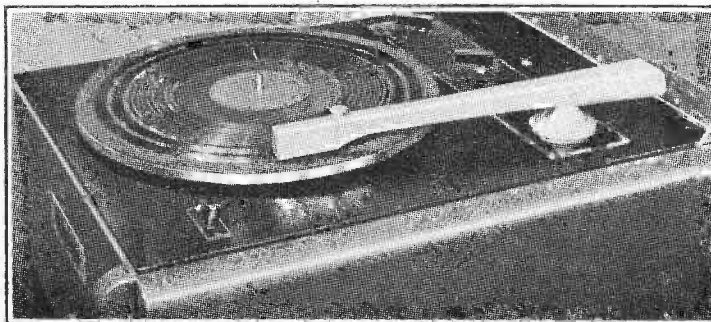

UNBIASED

Silent Music

IT is a little difficult just at present to know what is the best use to which we can put our now apparently useless television sets. One hesitates to use them as extra coal bins, as is being done by many people of the type who are devoid of all sense of decency. Even the sound side is of no use as it stands, and, personally speaking, I have lost no time in converting my own receiver to a first-class multi-valve short-wave set, in order to be able to receive the American programmes at all hours of the day. This has, of course, necessitated rewinding all the coils, and has meant a great deal of hard labour, but it has been fully worth it, not so much because of the ability to receive the transatlantic programmes with ease, but because of a very remarkable discovery which I have made.

It so happens that Mrs. Free Grid possesses among her hundred-odd relatives an individual who is a very big noise in the musical world; at any rate, even if he isn't a very big noise, he certainly makes one when he is let loose with a conductor's baton and a full-blown symphony orchestra. As he is staying with us I managed to rope him in to help me with some of the conversion work, the bait which I held out to him being that he would be able to listen to some of the wretched highbrow musical stuff which certain American stations of a Bostonian turn of mind are apt to churn out from time to time.



Sublime ecstasy.

I supervised his efforts as far as possible, but it was not to be expected that I could keep my eye on him all the time, and it was not surprising, therefore, that when we had finished and I attempted to tune in a short-wave station by way of a test the loud speaker was dumb. I left him for a few moments idly twiddling the knobs while I went in search of a hammer to remedy the defect, and was amazed on my return to see him kneeling enraptured before the cathode-ray tube with a far-away look of sublime ecstasy on his face.

Knowing that Mrs. Free Grid's family are tainted with a certain amount of what

the doctors somewhat euphemistically call nervous instability, I momentarily feared the worst and took a firmer grasp on my hammer. Glancing at the cathode-ray tube I noticed that it was filled with the dancing curves of what was obviously an incoming signal. A swift examination revealed what was happening. The cathode-ray tube had somehow or another got connected up instead of the loud speaker, and the efforts of the orchestra at some far-distant short-wave station, instead of being translated into sound by the loud speaker, were being transmuted into "curves" by the cathode-ray tube.

To my astonishment I discovered that Mrs. Free Grid's relative was able to "read" the curves and extract full æsthetic enjoyment from them in a somewhat analogous manner to the way in which many practised musicians are able to get as much enjoyment out of reading an orchestral score as they do out of hearing an actual performance of the orchestra. It was, of course, very stupid of me not to have realised this previously, for, as I told you some time ago, it was already within my knowledge that many musicians find no difficulty in reading the score from a gramophone record.

To my mind this remarkable "silent music" discovery has great possibilities, for if we can only educate the general public to connect up a cathode-ray tube in place of a loud speaker we ought to solve once and for all the problem of the noisy loud speaker, for you will, of course, realise that if music can be "read" in this way there is no reason why news bulletins and talks should not be similarly "read"; Rudolph Pfenniger has, indeed, already given us an Irishman's lead in this respect.

Modernising Medicine

I AM very astonished to learn from a reader who has written from a certain regimental depot "somewhere in England" that the Army is still sticking to the old-fashioned form of medical examination which has been prevalent since the Norman conquest. Each recruit has apparently to file personally in front of a doctor for examination, thus not only wasting the time of the medical profession, who are compelled to journey daily to the various examination centres, but wasting also valuable petrol and oil in unnecessary car journeys by the doctors.

Much as I regret to say it, we are, I fear, very much behind certain other countries in this respect. It must, I think, be fully five years ago since I was privileged to inspect the arrangements made in one of the South American republics to examine a large number of men with a minimum wastage of the valuable time of

By FREE GRID

highly paid doctors. This scheme has actually been perfected as the result of the necessity of coping quickly with the numerous revolutionary epidemics which break out in these countries during the hot weather, just as measles and 'flu trouble us over here in the winter.

In the particular country to which I am referring, the human body is marked out in squares just like the football ground

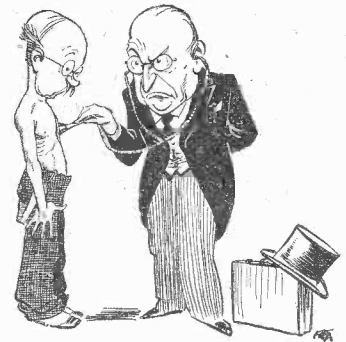

Passing the M.O.

in a B.B.C. commentary. Each recruit passes in front of a trained orderly who first places a microphone on a certain part of the would-be soldier's torso, at the same time shouting "square one" in a stentorian voice. At the other end of the line is a listening doctor who, on hearing the stentorian "square one" come over the wire to him, at once knows from the chart before him that he is listening to the man's uvula, and records his impressions of it, favourable or otherwise.

In this way the doctor is able to deal quickly with a large number of candidates without leaving his headquarters and so cluttering up the roads with his car and wasting good petrol. One doctor is thus able to deal with candidates all over the country instead of a large number of doctors being employed to give a personal medical examination to every man, as still seems to be the case over here. No doubt by now this method has been vastly improved upon, and for aught I know recruits are examined even more thoroughly and quickly by placing them in front of a television transmitter. If this method were adopted here the B.B.C.'s after-the-war problem of finding the money to build provincial television stations would be solved, as they would be able to acquire at knock-out prices all the stations erected by the Government at the medical examination centres. I am writing to the War Office about the matter before it slips my memory. No doubt a grateful country will reward me suitably after the war.

NEWS OF THE WEEK

RESERVED OCCUPATIONS

The Wireless Industry

THE purpose of the revised Schedule of Reserved Occupations issued recently by the Ministry of Labour is to ensure that workpeople required for the maintenance of necessary production or essential services are not accepted for service in which their skill and experience will not be used.

Against each occupation in the list is given an age which, in general, means that men who follow those occupations, whether they work on their own account or are employers or employees, cannot be accepted for whole-time service in any of the Services of National Defence if they are of or above the age given. Men below the age mentioned can be accepted for service subject to the restrictions, in the case of certain occupations, that a man may only be accepted if he is required in his trade capacity.

Men in listed scientific or professional occupations may be accepted at any age for service in their scientific or professional capacity in any of the Services of National Defence

The Schedule, which is arranged alphabetically in groups of occupations, is to be used, except where stated otherwise, without regard to the particular industry in which any occupation is followed. This means that there are many reserved occupations which apply to the wireless industry; however, only those which are inherently radio are quoted below (with the minimum age against each).

B.B.C. Staff (Administrative and Executive grades)	25
Wireless valve maker	21
Laboratory assistant	25
Scientific research worker (full time) in a University, Technical College, Research Association, Research Institute or Research Laboratory	25
Wireless operator (sea-going), radio officer (sea-going)	18
Wireless operator (not sea-going)—Post Office	21
Wireless operator (not sea-going)—other than Post Office	30
Clerical assistant engaged full time on "feeder" duties (telecommunication services)	25
Student of recognised wireless telegraphy school who has completed three months' training	30
Rigger (wireless masts, etc.)	30
Wireless engineer	30
Fault finder, tester	30
Wireless (radio) repairer, wireless mechanic, service man (wireless)	30
Loud speaker cone maker	30

RELAY EXCHANGES

Services During the War

RADIO relay exchanges have now been authorised to distribute emergency messages if requested by the local Chief Constable or Air Raid Precautions Controller.

Announcements must be confined to instructions and warnings bearing on local precautions or other local emergency arrangements, and should not deal with the matters of general application such as are covered by announcements made on behalf of the Government.

In no circumstances are relay exchanges to be used for announcing the existence of fires or gas-contaminated areas, particulars of damage caused by enemy action, details of losses inflicted on enemy forces, or despatching any air raid warning messages other than the "action warning" and "raiders passed." The passing of these latter messages over the relay system is not to be regarded in any degree as a substitute for the official public warning signals.

Under no circumstances is the use of loud speakers fed from a relay system to be permitted in streets or open spaces.

Single-programme relay exchanges must give the B.B.C. Home Service during the hours when the exchange is providing a service, and dual-programme exchanges must relay this programme on one channel.

Musical items from foreign stations may be relayed, but no talks or other spoken items from such stations are to be included.

BROADCASTING AND THE PRESS

DURING his first speech in the House of Lords as Minister of Information, Lord Macmillan stated that a feature which was a novelty in the present war was that alongside the great organs of the Press in the organisation of publicity was broadcasting.

The B.B.C., Lord Macmillan said, in competition with the Press, had an enormous advantage because it could go on day and night, and one of the earliest problems that had fallen to him was to see that broadcasting should not be allowed to prejudice in any way the reasonable rights of the Press.

FOREIGN BULLETINS

News for the Balkans

FURTHER increases in the number of bulletins broadcast by the B.B.C. in foreign languages were announced last Friday. The additions were Serbo-Croat and Rumanian. These bring the total number of foreign languages used in the Oversea transmissions to twelve, which previously included Afrikaans, Arabic, Czech, French, German, Italian, Magyar, Polish, Portuguese, and Spanish.

An additional Italian bulletin was introduced last Friday at 12.45 p.m. G.M.T. and broadcast on 41.49 and 25.29 metres.

The Rumanian and Serbo-Croat bulletins are broadcast at 8 and 8.45 p.m. G.M.T., respectively, on 30.96, 49.59, and 261.1 metres.

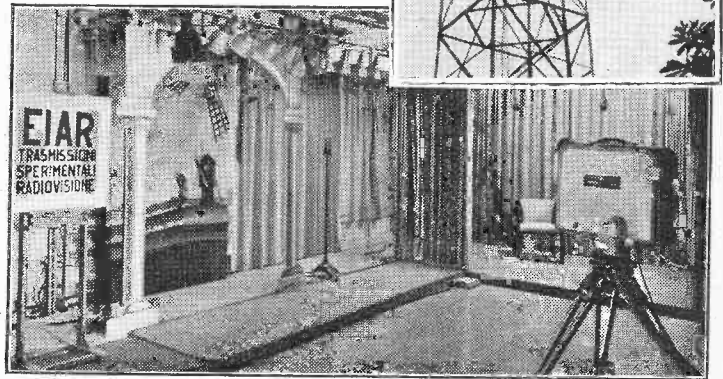
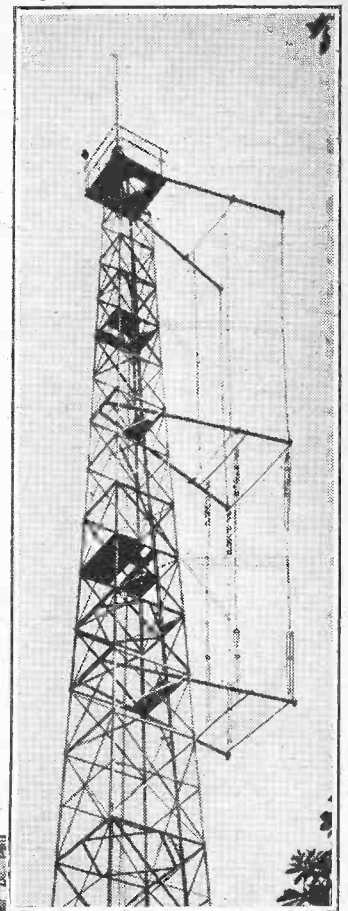

ITALIAN TELEVISION. The sound and vision aerials at the top of the 50-metre tower of the Rome television transmitter which is situated at Monte Mario. At present the programmes are transmitted daily from 7.15 to 8.30 G.M.T. on 6.8 metres (vision) and 7.4 metres (sound). The studio shown here is at the E.I.A.R. headquarters in Rome and is connected to the transmitter, which is some distance away, by co-axial cable.

DEFENCE COMMUNICATION

Proposed Australian National Emergency Plan

AUSTRALIA, because of its vast area, needs a more efficient and varied communication system in time of emergency than do smaller and more compact countries. In an article in the June issue of the Proceedings of the Institution of Radio Engineers, Australia, Mr. N. S. Gilmour, the president, submits a plan for providing Australia with "the most comprehensive and modern interlacing of radio communication ever attempted."

The plan is to honeycomb the populated areas of Australia with self-powered transmitter-receiver units of the type already proved in the outback of Australia. In addition, extra units would be provided so that under predetermined circumstances many hundreds of these

units, complete with observers, rations, and tents, could be transported to unpopulated points where any raid is expected. The stationary units would be located at the homes of approved residents and the women-folk trained to operate them in emergency, as is regularly done in the outback. This would give the women of Australia an opportunity of training for a most important service in the protection of their country.

In addition to the above transmitter-receiver units, Mr. Gilmour's plan provides for the issue to approved residents of the receiver portion only of the unit, so that under predetermined circumstances they would listen-in to these emergency sets (when the regular services failed) and receive instructions

News of the Week—

which they would distribute by other means to their immediate neighbours.

It is proposed that 5,000 self-powered transmitter-receiver units should be provided at a cost of £425,000, and 35,000 self-powered receivers at a cost of £525,000. Administration and maintenance is estimated to cost £100,000 per annum.

The stations would operate on the same short wavelength as the outback sets, and so provide for interchangeability.

R.S.G.B. CARRIES ON

THE Council of the Radio Society of Great Britain has resolved that the work of the society shall continue for as long as possible. In making this decision the Council expressed the view that it is essential for the future of amateur radio in Great Britain that a strong and virile organisation must remain in being.

In order to maintain a link with its members and also between individual members, it has been decided to continue the publication of the Society's journal, *The T & R Bulletin*.

Although the activities of the experimental section must necessarily be curtailed, the Council anticipates that arrangements will be made for certain of the groups to function, and it is hoped that local activities will continue as far as circumstances permit.

Having reprinted "The Amateur Radio Handbook" last month, the society is in danger of losing about £300 on this venture unless the stock can be reduced. The Council would be grateful if every member will consider purchasing an extra copy (price 3s. post free) or will recommend it to friends.

"BROADCASTING IN EVERYDAY LIFE"

WHAT social changes have been brought about by broadcasting? In a booklet with the above heading, recently published by the B.B.C., two woman investigators give a survey of the social effects of the coming of broadcasting. The investigators, who are from the Bristol University Settlement, surveyed a comparatively small, thickly populated working-class neighbourhood in East Bristol.

They declare that, for the wage earner of all grades, broadcasting has taken its place as a normal feature of home life. "It may be said," they state, "that no social innovation since the coming of compulsory elementary education has affected so large a portion of the working population as has the coming of broadcasting."

"Broadcasting in Everyday Life" costs one shilling.

NEWS BULLETINS AND TIME SIGNALS**B.B.C. Schedules**

THE B.B.C. Home Service is now being radiated for more than seventeen hours a day—from 7 a.m. until 12.15 a.m. During this period there are now six regular times for news bulletins. These are given at 8 a.m., 12 noon, 4 p.m., 6 p.m., 9 p.m., and 12 midnight. Official and other public announcements are broadcast at 7.30 and 10.30 p.m. If and when there is any important news it will be broadcast at 1, 3, and 5 a.m., and at every hour throughout the day.

In order to preserve the regional spirit of broadcasting, announcements, etc., intended primarily for listeners in different parts of the country are being broadcast at special times each evening. At present London and Northern announcements are broadcast at 6.15, Welsh and Western at 7.0, Scottish at 7.45, and Midland and Northern Ireland at 10.45.

Time signals are now broadcast nine times during the day. They are given at 7 and 8 a.m., 12 noon, 4, 6, 7.30, 9, and 10.30 p.m., and 12 midnight. Seven of these are from Green-

wich, and two, those at 7 a.m. and 4 p.m., are of Big Ben.

SUMMER TIME ENDS?

WITH the reversion from summer time to standard time on different dates throughout the world there is the periodical confusion to listeners to foreign short-wave stations.

On Sunday, September 24th, the Eastern part of the United States returns to Eastern Standard Time (E.S.T.) and the times of all programmes emanating from the N.B.C. and C.B.S. short-wave stations will be "six hours back" until we in England revert to G.M.T. This should be on October 8th, but it is not yet known whether the proposal to postpone the reversion will be adopted.

In a recent issue of the N.B.C.'s short-wave news sheet, which, printed in six languages, gives weekly the times of the programmes from its international short-wave stations, WNBI (ex W3XL) and WRCA (ex W3XAL), a list of standard times is given.

BRITISH NEWS BY WIRELESS**High-power S-W Stations Suggested for the Dominions**

THAT the British Empire has failed to make full use of its overwhelming advantages in respect of obtaining world coverage by wireless is stressed in an article under the above heading which appears in the September issue of *The Round Table*. It is pointed out that countries like Germany or Japan must radiate to the whole world from their own home territory. They cannot establish radio stations at the other ends of the world under their own flag. Great Britain can.

Although every one of the Dominions has a medium-wave broadcasting service for its own national purposes, none of them has a short-wave service capable of giving reciprocity with the Empire service from the United Kingdom, let alone affording world coverage.

"Australia," says the writer, "has inaugurated a short-wave service which can be heard in the South Pacific zone, but it is only of low power, and can hardly be regarded as more than a regional expansion of the local broadcasting service. There is a short-wave station in South Africa of which the same is true, though its power is larger. All-India Radio, controlled by the Government of India, has several short-wave stations, but they are designed entirely for Indian purposes, being more effective than medium-wave

stations for so large a country with such difficult physical conditions. In fact, there is not anywhere in the whole British Commonwealth outside Great Britain a single high-power short-wave broadcasting transmitter."

Liability or Asset?

The writer of the article emphasises the fact that the far-flung Empire became, in the matter of broadcasting, a liability to the B.B.C. rather than an asset to British Commonwealth broadcasting as a whole.

"Two things in particular," says the writer, "would have been, and are still, needed to turn its distances and its geographical variety from a liability into an asset. The first is the erection of high-power short-wave radio transmitters in the several oversea Dominions, with the possible exception of New Zealand, and also in India. The second is the erection, at two or three focal points in the dependent Empire, of high-power short-wave stations to relay B.B.C. programmes, and to re-broadcast translations of those programmes in the languages of countries in their region. These measures should have been taken long ago, but it is not too late. The need to take them has increased, not diminished, by the delay hitherto."

**FROM ALL
QUARTERS****Car Radio Ban in Paris**

A PRESS report states that the fitting of wireless sets to cars or motor cycles is forbidden under an order issued by the Prefect of the Paris police last Sunday. Sets which have already been installed must be removed, with all their accessories, within 48 hours.

Manchester Show

THE Northern Radio Exhibition, which, organised by *The Manchester Evening Chronicle* and Provincial Exhibitions, was to have been held in the City Hall, Manchester, in October, has been cancelled.

Continental Radio Shows

ALTHOUGH the two French radio exhibitions which should have been held at the Grand Palais, Paris, from September 7th and at Lyons from September 16th have been cancelled, the Belgian radio shows are being held as arranged. These are the XIth Salon de la T.S.F. which opened at the Grand Palais du Centenaire, Brussels, on September 9th, and the Antwerp radio show which opens on September 23rd.

Transatlantic Radio-telephone

THE first direct wireless-telephone service between Italy and New York was inaugurated last week with a forty-five per cent. reduction on the existing charges for week-day calls by the indirect route.

Iranian Broadcasting Stations

It is reported that thirteen of the sixteen broadcasting stations which the Iranian Government has ordered will be for medium-wave working, while the remaining three will operate on the short waves. Two of the short-wave transmitters will be erected in Teheran, the capital.

New Guinea Radiophone Service

A RADIO-TELEPHONE service has been inaugurated between four towns in New Guinea by Amalgamated Wireless (Australasia). Although the distances between the towns is no more than sixty miles, the roughness of the intervening country makes the use of cables impracticable.

Pacific Island Station

A WIRELESS and meteorological station is to be built at Raoul, on Sunday Island, in the Kermadec Group, in the Pacific. It is being erected by the New Zealand Public Works Department in the course of a plan to provide landing grounds and wireless and meteorological stations on New Zealand's Pacific Island dependencies.

Emergency Addresses

HERE are two additions to the list of emergency addresses published last week of manufacturers who have moved their offices to the country:—

Marconiphone Co., Ltd., Sales Dept.; Bourne Bridge, Hayes, Middlesex. Order Dept.: 100, Blyth Road, Hayes, Middlesex.

W. T. Henley's Telegraph Works Co., Ltd., Milton Court, Westcott, Dorking, Surrey. (Tel.: Dorking 3341.)

Scanning Coil Construction

THE SHAPING PROCESS

By PAUL D. TYERS

CONTINUING the discussion of making scanning coils, the author shows in this article how the coils can be shaped after winding. He describes the necessary jigs and gives some illustrative winding data.

WE will assume that the coil has been wound and is now lying on the mandrel. If desired, during the winding a little cement may be run on to the rectangular portion of the winding, but in any case the cheek should be carefully removed, thus fully exposing one side of the coil. The rectangular portions should be symmetrical and what will ultimately be the bend-over portions should be lying bunched up at the sides. Now apply a little more cement and allow it to become tacky. The coil can now be lifted carefully off the core and bed. If it tends to stick it may be gently levered up with a thin but blunt strip of material to avoid cutting into the insulation.

The bend-over portions have now to be bent at right angles and this must be done without distorting the rest of the coil. The coil is therefore turned over and placed on a flat surface. Either the core piece or another piece of metal of similar dimensions is dropped inside the window and a flat bar of wood is laid across the coil. The width of the bar is, of course, equal to the length of the rectangular portion. Pressure is applied to the bar and

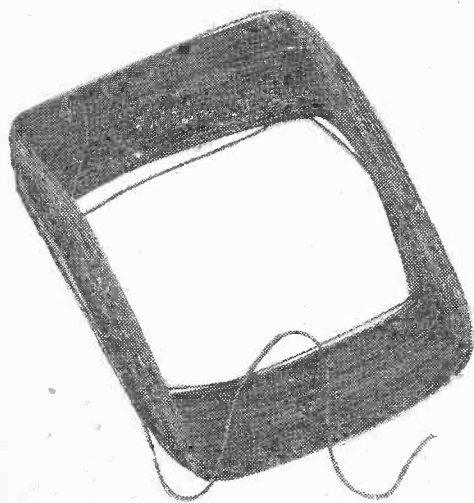
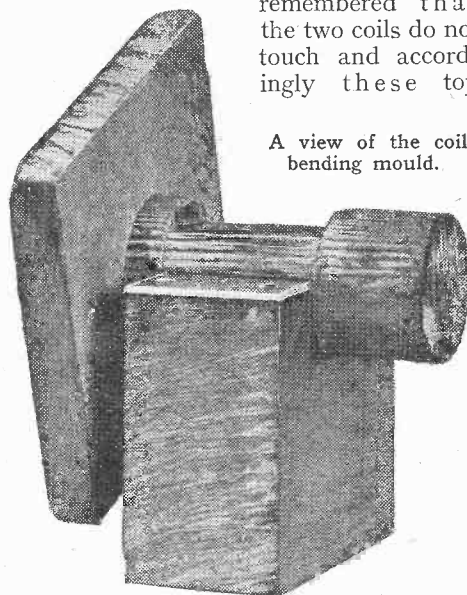

Fig. 8.—A coil removed from the winding mandrel with the "bend over" turned at right angles. Particularly note that as the rectangles are not dry, and as the coil is not yet moulded, the shape is imperfect. This is corrected in the moulding operation.

Concluded from page 250 of last week's issue

the edges of the coil which at present are undoped and are therefore very tractable, are very carefully bent up so that they lie against the sides of the pressure bar. This gives a coil having the shape of Figure 8.

The coil thus bent and still in a tacky condition is transferred to the mould. The drawing of Fig. 9 and photograph should make the arrangement quite clear. The mould consists of a cylindrical core and two side pieces, conveniently made from a single block of hard wood. These have top plates which are brought to the correct distance above the centre line. It will be remembered that the two coils do not touch and accordingly these top



A view of the coil bending mould.

plates, which locate the edges of the coil, are naturally above the centre line. The cylindrical core has a flat cut into it parallel with the top plates. This flat locates a top bar which has to be removable. The width is exactly equal to the length of the rectangular portions of the coil. The length is of no importance, and the thickness is sufficient to enable it to withstand pressure. A long woodscrew going right through the core and into the wooden block is the most convenient fixing arrangement.

The coil, with the edges bent at right angles and the active portions doped, is allowed to become nearly dry and is then placed on the mould. The top bar is carefully placed in position and screwed firmly into the mould. To guard against the dope sticking to the wood it is best to boil the wood in wax. In addition, the insertion of scraps of thin tissue paper help to guard against sticking.

There are two further parts of the mould, the wedges and the end cheeks. The wedges make a friction fit between

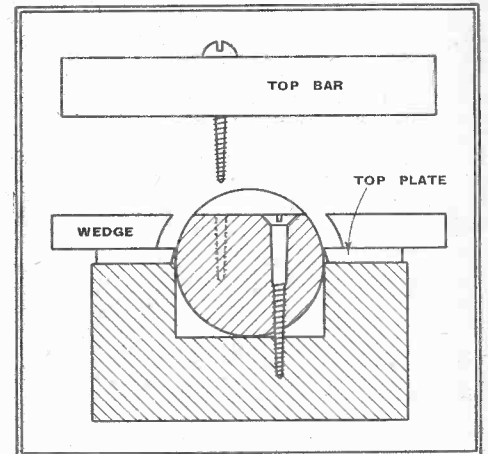

Fig. 9.—This sketch gives details of the mould.

the top pieces and the top bar and are curved to the outer surface of the coil. They are best made from hard wood by turning out a circular hole of the exact size and cutting them out of the block as shown in the sketch.

Careful insertion of the wedges presses the rectangular portion on to the curved surface of the core. This will have the effect of pushing the loose sides outwards. The end cheeks are flat pieces of wood with a hole of the same size as the core. It is at this stage that the edges of the coil are doped, but not until they have been roughly formed up to shape by hand. When they become tacky the end cheeks are pushed on and clamped firmly in a vice or suitable clamp.

Aligning the Coils

When the mould is dismantled the perfectly formed coil is simply removed and is then ready for mounting. It is general to assemble the coils on a very thin-walled tube of paxolin. When the coils are wound with thick wire and are operated from a transformer they are quite self-supporting and there is no need to tape them completely.

Accurate alignment is necessary, and as

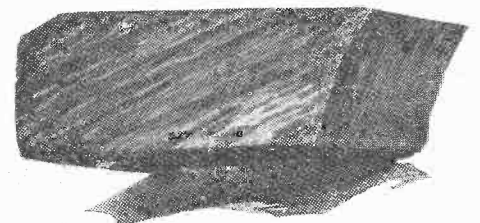

One of the wedges used in shaping the coil.

the edges do not touch a distance piece should be inserted. For this purpose paxolin or cardboard may be used. As the two sets of coils have to be interlaced, one set must obviously be shorter than

Scanning Coil Construction—

the other. As line scanning is more difficult the line coils are always made the long set. In making the frame coils the bend-over portion has to be longer as it has to clear the line coils. The line coils are set up on the paxolin tube and the frame coils are then dropped into position.

In the case of a long tube the gap distances are greater and the deflecting field is lower than with a short tube. Accordingly the coils are held on the tube by taping them. With a short tube a greater

wire coils are more easily treated by the hot wax process than dope, and in the case of a short tube assembly very great care is necessary.

Lead-out flexible wires should be soldered to the ends of the coils and anchored on the bend-over with a small piece of adhesive tape. It will be realised that in the case of a short tube assembly there is little room to spare between the coils and the core and the minimum possible quantity of oiled silk tape should be used over the coils.

It may be thought that it is not worth while making special jigs for a single set of coils. It can be very definitely stated that the production of an accurate coil by hand without any mechanical assistance whatever is an exceptionally difficult matter. In any case some winding arrangement must be made, even if the bending is attempted by hand. The advantage of a precise coil is shown by the symmetrical evenly focused scan which is obtained. An inaccurate coil will give a distorted raster and in the

case of a short tube the accuracy of the focus which is obtainable may leave much to be desired.

It should be realised that the subject of magnetic scanning is one involving many points and the present notes must not be regarded as either final or exhaustive. Field distribution obviously plays a

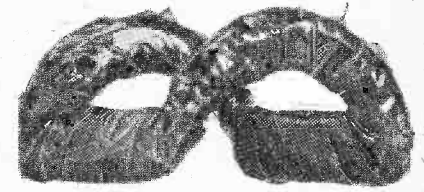

The finished coil after shaping.

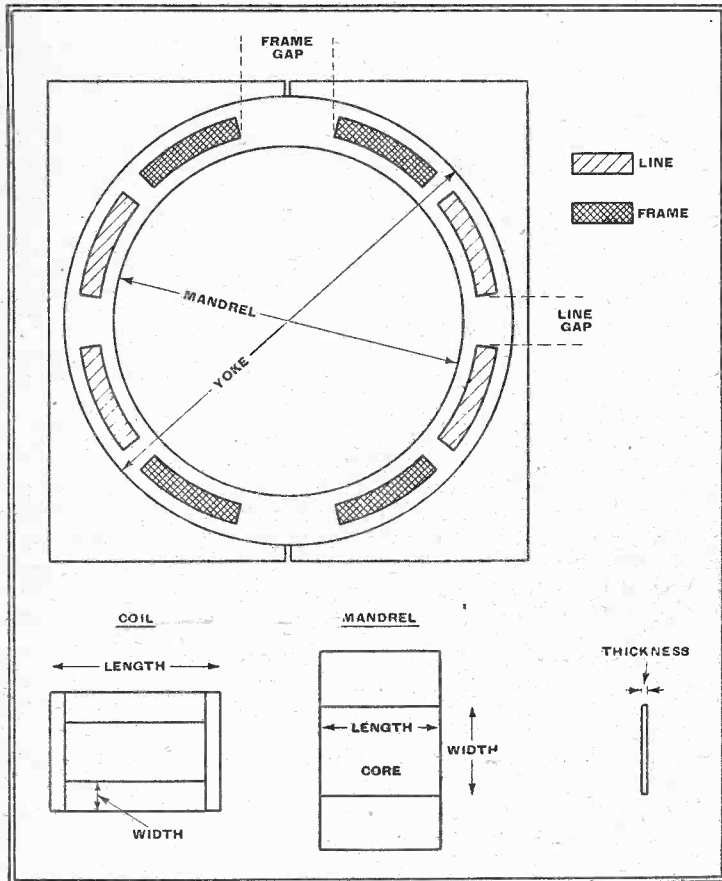

very important part in determining the form of the resultant scan, which is controlled both by the shape of the active part of the coil and also the relative position of the turns. There are two methods of controlling the turn distribution, first by the inside configuration of the winding cheek, and, secondly, by the gauge of wire. If the cheek is not parallel with the bed, but slightly inclined, the turn distribution over the active part of the coil is varied. This, however, gives a coil of unequal thickness and a certain amount of useful winding space is lost if the coil is encircled by an iron circuit. The second method of using two or three different gauges of wire is in the writer's opinion a more practical solution and this is a subject which lends itself to easy and interesting experimental work which should have a great appeal to the experimenter.

The writer has endeavoured to indicate how by a little effort and at small expense the enthusiast can make scanning coils capable of giving really satisfactory results.

The drawings on the left give details of the dimensions in the table.

COIL AND JIG DATA
LINE

Tube	Coil				Core		Thick-ness (mm.)	Gap (ins.)	Man-drel (mm.)	Yoke (mm.)
	Turns	SWG	Length (ins.)	Width (ins.)	Length (ins.)	Width (ins.)				
Mazda, CRM 121...	180	31 Enamel Silk	2	1/2	1 3/8	1 3/8	2	5/32	38	44.5
Mullard, MW 22 ...	230	30 Enamel Silk	2 1/4	1/2	1 1/2	1 3/8	3	1/4	38	44.5
Marconiphone, 3/3	120	26	2 3/4	5/8	2 1/2	1 3/4	3.2	1/4	45	—

FRAME

Mazda, CRM 121...	1,200	41 Enamel	1 1/2	1/2	1 3/16	1 1/4	2	5/16	38	44.5
Mullard, MW 22 ...	230	30 Enamel Silk	1 3/8	1/2	1 1/2	1 1/2	3	1/4	38	44.5
Marconiphone, 3/3	2,000	40 Enamel	2	1/2	1 1/2	2 1/4	4	7/16	45	—

NOTE.—The above table must not be regarded as official recommendations. The recorded values are taken from laboratory records of coils which have given satisfactory scans. It should be realised that other dimensions can also be used and the above figures should be taken as a guide as to what is required.

field is necessary and this is normally increased by means of an iron circuit yoke built up from C shape stampings so as completely to encircle the coil. The stampings are stacked to a distance of about one inch and are conveniently held in a metal clamping frame. This can be made from thin tin plate with the aid of tin snips. Such an assembly will hold the coils in position. An experimental coil assembly for a short tube built in the writer's laboratory is shown in the photograph.

Finishing the Coils

It is not necessary to use a low-resistance coil and transformer for frame scanning in which case a large number of turns, about 1,000, of fine wire are employed. This is much more delicate to handle than that used for a low resistance coil and accordingly it is not safe to press it in a mould without protection in the form of extremely thin oiled silk tape which is simply lapped round it. Fine

Sight and Sound

SOME CLOSE RELATIONSHIPS BETWEEN SOUND REPRODUCTION AND TELEVISION

By "CATHODE RAY"

THE coming of television has brought a great deal of interest into radio. It has also brought an alarming addition to the amount of stuff to be learned! Photographers, and especially cinematographers, are at an advantage here, because things such as "depth of focus" and "critical flicker frequency" are already familiar to them. It is surprising how many radio men are interested in photography. Quite possibly television is stimulating this interest.

In acquiring a new technique it is helpful if there are close parallels, or analogies, with what one already knows. Although in some respects television is very different from sound reproduction, and includes things that have nothing to correspond with them in sound, there are also some parallels. Anybody who knows anything at all about the two systems can see that as the microphone "picks up" the voice, and the camera the picture, these two appliances correspond to one another. At the receiving end the loud speaker and the cathode-ray tube are similar in function because they are the

reproducers of their respective parts of the programme. In between, the two systems are almost identical in general nature, because both are required to handle and transmit electrical signals. In fact, at some stages (for example, the receiving aerial and parts of the receiver) the same appliance is made to serve for both at once. Where television shows its independence is in its extending to an additional dimension, necessitating at both transmitting and receiving ends extra apparatus to distribute the light and shade in a systematic manner over the area of a screen. These agreements and disagreements are shown here diagrammatically.

The whole of this apparatus can be considered as electrical equipment. What comes before the microphone and after the loud speaker is, of course, *sound*, and before the camera and after the screen *light*. These two things are different, in that sound is a mechanical movement of the air, while light is electrical in nature, differing from radio signals only in the

detail of wavelength, and, like them, needs no air or other substance to act as a conveyor. But sound and light are in other ways very similar, because they both move in waves having measurable frequencies. The human ear and eye are restricted to certain narrow wavebands of each, which, therefore, are the wavebands in which the greatest practical interest is taken. The frequency limits of the ear run from about 20 to 20,000 cycles per second; of the eye, from 400,000,000,000 to 750,000,000,000,000 cycles per second. The ear therefore responds to a frequency ratio of 1,000 to 1, but the eye to less than 2 to 1, or barely one octave. Change of frequency is *heard* as a difference in pitch, and *seen* as a difference in colour.

One of the things that is most discussed in connection with sound-reproducing apparatus is the frequency characteristic, so it is well known to readers of *The Wireless World*. You all know, for example, that inferior microphones, amplifiers, or loud speakers fail to operate with equal effectiveness over the whole audible frequency scale. And so there is a certain amount of *frequency distortion*. But, even though

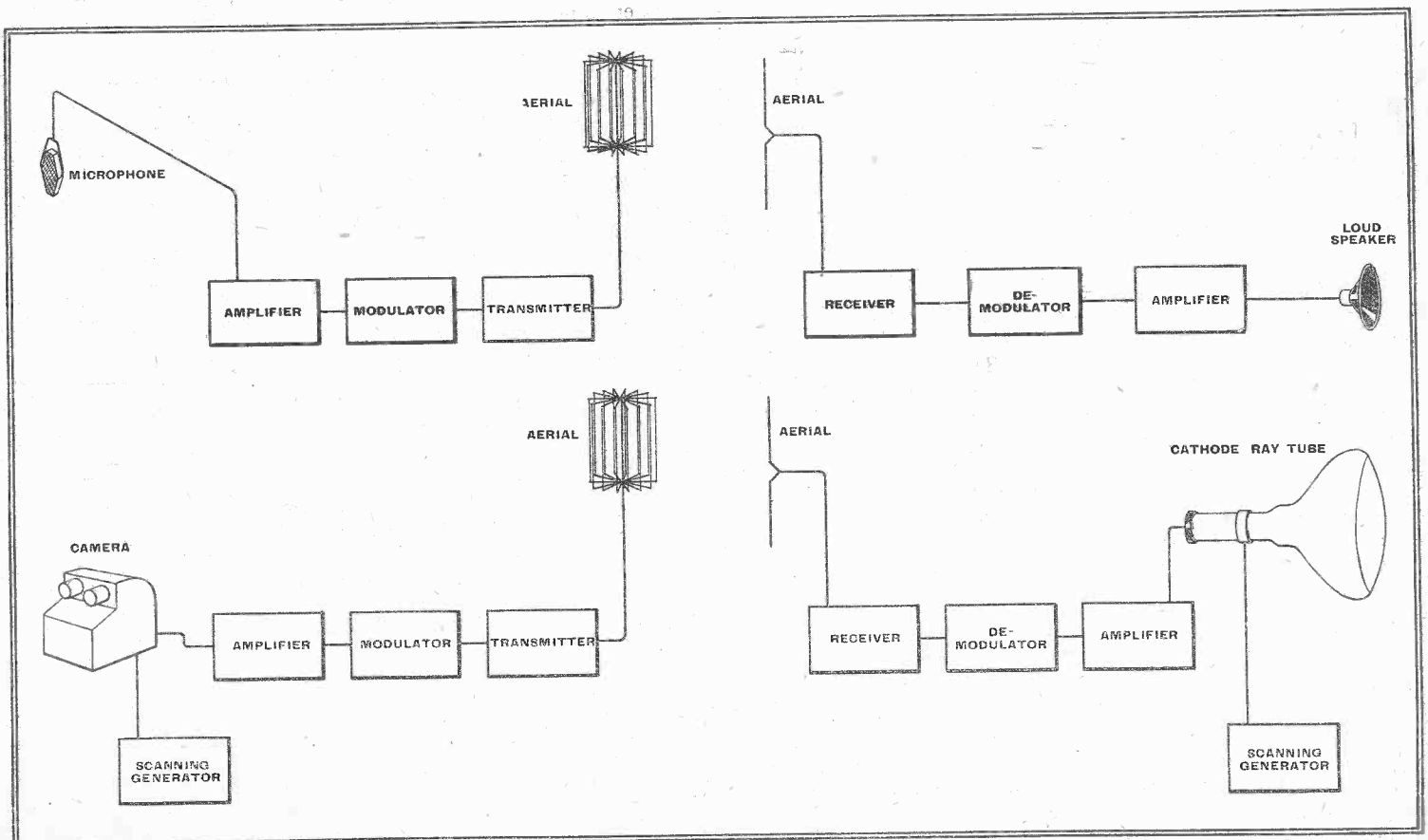

There is an obvious analogy between the various parts of sound and vision broadcasting and reception systems. In the case of the receiving aerial, and usually a good part of the receiver, this analogy extends to an absolute identity. On the other hand, the scanning arrangements at each end are peculiar to television.

Sight and Sound—

there may be some imperfections or restrictions, the original sound frequencies are more or less preserved in the electrical signals passed from microphone to loud speaker, and subsequently in the reproduced sound. That is because those frequencies are low enough to be amplified directly, or carried by the higher radio frequencies. Light frequencies are so enormous, however, that they cannot be handled at all by valves or other electrical equipment. Only the variations in *strength* of the light are low enough in frequency, and even they need ultra-high-frequency radio to carry them. So *colour* is destroyed entirely. Fortunately, the picture, having an extra dimension, suffers less than sound would if the reproduction were reduced to a note of unvarying pitch, merely changing in volume! Distribution of light and shade serves as a very acceptable substitute for colour. If colour television is wanted, the only ways of obtaining it are outside the electrical chain of apparatus—by means of successively interposed colour filters, etc. The various colour frequencies cannot actually be transmitted.

Light and shade can be acceptable as a substitute for colour only if it corresponds reasonably well to one's impression of the relative lightnesses and darknesses of colour. Photographers know how the earlier types of plates and films failed to do this, registering blue as white and red as black, notwithstanding that they might appear to the eye of about equal depth. Panchromatic materials were introduced to remedy this defect, because their frequency characteristic is much nearer that of the eye. The sensitive surface in the emitron camera is fairly good in this respect.

Although the colour of the reproduction is fixed, a fairly large choice of that colour can be made; but practically everybody plumps for that particular mixture of all visible colours which the eye sees as white light.

Amplitude Distortion

Evidently there is not a very close analogy between sound and picture reproduction so far as frequency distortion is concerned. But as regards amplitude distortion, the problems are much the same in the two cases. Amplitude distortion, of course, is a lack of proportion in reproducing the intensity. Taken on the scale of single waves, it causes the shape of the waves to be distorted; and in sound that has the effect of introducing new and undesirable sound frequencies. In television, there are effects on the picture definition but they do not occupy such an important place as amplitude distortion in sound. The most obvious sorts of distortion in the picture are due to the department that has no equivalent at all on the sound side—the scanning arrangements.

Amplitude distortion can also be considered on a longer time scale than single waves. Music, or almost any sound programme, has its quiet and loud parts.

The full range of these in music—the more serious sorts, at least—is very large, ranging from almost inaudible to “deafening.” Because of unavoidable limitations this range has to be compressed in transmission. It is possible to do a certain amount of expanding again at the receiving end, if desired. Much the same state of affairs exists in television. The eye can perceive at least 100 variations in shade between white and black, even after colour has been removed. Only something like a tenth of this number of shades can be reproduced successfully. The reasons are much the same. Very faint sounds are drowned by background hiss, hum, interference, etc. And very low lights in the picture are obscured by stray room light, reflections in the cathode-ray tube, halation, and so forth. Very loud sounds are limited by maximum undistorted output; and very bright lights by maximum undefocused screen fluorescence.

Incidentally, the impression of an increase in loudness depends not on the amount by which the intensity of sound has been raised, but by the ratio in which it has been raised. That is to say, if an increase from 10 to 15 milliwatts produces a certain increase in loudness, the same increase in loudness is given by raising power from 100 to 150, not to 105. The same principle holds good in seeing. Both are examples of the Weber-Fechner law, which states the observed fact that human senses respond according to a logarithmic scale, or an approximation to it.

Contrast Control

The rate of contrast is under control at both transmitting and receiving ends, and is denoted scientifically by γ (gamma). If $\gamma = 1$, it means that the contrast is the same as in the original. Values less than 1 mean that the reproduced picture is flatter, and greater than 1, more contrasty, than the original. In cinema practice it is usually made rather more than 1, by way of compensating for loss of colour. The proper practice in television transmission has been the subject of discussion; but as it can be adjusted to personal taste at the receiver, perhaps it doesn't matter within reason, so long as it stays constant.

There is a risk, especially with sensitive amplifiers, of the 50-cycle mains butting in uninvited. The effect of this on sound reproduction is aptly called *hum*. Then there are sundry irregular voltages caused by a hundred-and-one electrical appliances, besides certain influences in the amplifier. The result, in terms of sound, is justifiably termed *noise*. As there is a lamentable shortage of suitable terms to apply to the variations in voltage or current that produce these effects they have to be referred to, for want of anything better, as noise and hum voltages (or currents). To avoid having to discriminate between voltage and/or current, and to save time generally, one gets into the way of calling them “noise” or “hum” as

the case may be. Now comes television, whose apparatus is subject to exactly the same undesired electrical intruders; and as a result the layman, who cannot be expected to follow the foregoing train of thought, is bewildered by hearing dark bars across the screen referred to as “hum,” or a speckled appearance of the picture as “noise.”

Wanted: New Names

Talking about absurdities of terminology, is it *quite* impossible for something to be done to avoid the prevailing habit of distinguishing between television receivers “with radio” and “without radio”? The former clearly means a receiver connected up by line to the Alexandra Palace or other source of programme. But it is invariably used to mean a receiver limited to the vision and sound from that station and unprovided for reception on any longer waves. Seeing that television broadcasting is just as much radio as any other broadcasting, a television receiver without radio, as described in so many catalogues, seems a rather useless thing to buy! In a desperate shift to avoid this error, receivers are sometimes advertised as including both television *and* broadcasting, or available at a lower price without broadcast reception. But if television isn't broadcasting, what is? Still another dodge is to express the distinction as television and *all-wave* reception. But the mere fact that the distinction is made proves that “all-wave” is wrongly named; if it were it would include the television waves.

Our particular interest, radio, seems to have been put under a curse so that never, *never*, will any of its language be appropriate, consistent, or logical, or in fact anything but a reproach and irritation. This seems to be off the point I started with. Yet perhaps not. . . . The object of this article was to assist clear thought by tracing the resemblances and differences between sound and vision technique. If anybody can think about them clearly at all, it is in spite of and not because of the language with which we seem to be obliged to talk about it.

The Wireless Industry

WOLFRAM PRODUCTS & REFINERIES, Ltd., makers of tungsten rod for contacts, etc., request that all future correspondence be addressed to 32, Tewin Road, Welwyn Garden City, Herts.

◆ ◆ ◆ ◆

The 1939-40 catalogue of Denco, Warwick Road, Clacton, Essex, contains full particulars of Denco-Polystyrene (British) insulating material and of numerous short-wave components in which it is incorporated.

◆ ◆ ◆ ◆

Leaflets describing the Models 45 and 47 valve testers, Models 30 and 35 oscilloscopes, and Models 90 and 95 universal and DC multi-range meters have been received from Taylor Electrical Instruments, Ltd., 45, Fouberts Place, Regent Street, London, W.1. The scales of all Taylor meters are hand calibrated to B.S. First Grade specification.

Test Report

MURPHY A76

AC Table Model Superhet with Special Short-wave Circuits
(Five Valves + Rectifier and Tuning Indicator) - Price £16 10s.

THIS is the third short-wave "special" to be produced by Murphy Radio, Ltd. It possesses the good qualities of its predecessors—ease of tuning and sensitivity comparable with medium-wave standards—together with improved second channel suppression and greater stability of tuning. These improvements have not added to the complication of the receiver; in fact, the circuit is much simpler than the double-superheterodyne arrangement previously employed.

Circuit.—The basic circuit for medium and long waves is similar to that of the Murphy A72 in which a triode-hexode frequency-changer is followed by a single IF stage, a combined signal, rectifier, AVC rectifier and first AF stage, and a beam tetrode output valve. Two degrees of selectivity are provided in the IF stage by increasing the coupling in the first IF transformer. The normal coupling in association with tone correction in the output stage permits an audio-frequency response up to 4,500 c/s, and this is expanded to 6,500 cycles in the position of minimum selectivity. At the other extreme the top response is reduced below 4,500 c/s by the tone control.

Additional tuned filters are introduced in the AF stages to "clean-up" the response. One is a sharply-tuned series resonant circuit connected across the output transformer primary to suppress heterodyne whistles between adjacent channels, and the other is a heavily damped circuit tuned to approximately 3,000 cycles in the cathode return circuit of the output valve. The object of this circuit is to introduce negative feed back in the region of 2,000-4,000 c/s where the loud speaker response might tend to show

SETS FOR WARTIME

RECENT events have shifted the centre of interest from medium and long waves to the short-wave broadcast bands. We have therefore arranged to review a number of sets in which special attention has been given to short-wave performance. Last week we reviewed the British McMurdo Silver "15-17" and in a later issue we shall be dealing with the Pye "International"

harshness on some types of transmission. Advantage has been taken of the three-gang tuning condenser required by the short-wave design of the A76 to introduce a further stage of preselection on medium and long waves. The image suppression in these waveranges is therefore better than in the A72 receiver.

Adequate image suppression on short waves involves the use either of a very high intermediate frequency or a number of tuned RF circuits before the frequency changer. In the A76 the later alternative has been adopted, thus enabling the standard 465 kc/s IF components to be employed and also saving the additional valve necessary for double-frequency changing.

Seven broadcast and amateur bands in the 16-50 metre range have been selected and separate groups of coils provided for each band. Single tuned circuits precede the RF stage, which is only in operation on short waves. Since the aerial tuning is broad and the frequency range of each band is narrow, the tuning of each of

these aerial circuits has been pre-set. In the coupling between the RF and frequency-changer valves, on the other hand, there are two tuned circuits, and both these and the oscillator circuit are ganged and "bandsread" by the main tuning condenser, a small series capacity being introduced in each case to reduce the total effective change of capacity.

To minimise "warming-up drift" due to changes of capacity in the valve and associated circuits, the stray capacities are swamped by employing a comparatively high minimum across each tuned circuit. Experience gained in designing stable tuned circuits for push-button tuning has been drawn upon in selecting the types of fixed condenser used for this purpose, and the long-term calibration accuracy has also been greatly improved.

The valve used in the RF stage has the high mutual-conductance of 8 and was designed originally for television work. It has shown itself capable of giving a very high gain with a low signal-to-noise ratio on short waves.

Performance.—Those who receive their introduction to short wave listening through the medium of the A76 may be accounted fortunate. They will no doubt take for granted the ease and stability of tuning and will settle down to enjoying the variety of programme material on the short-wave bands which they have been accustomed to receive on medium and long waves.

On the other hand, those with previous experience of ordinary all-wave sets may find it lacking in "punch." If they will take the trouble to investigate they will find that this rather vague description of apparent liveliness and sensitivity was in reality attributable to severe second channel interference. A proper appreciation of the qualities of the Murphy set comes not from general impressions of a whole wave-band, but by comparison of the reception of individual stations with the same stations as received on a set without adequate pre-selection. The superiority of the A76 in the matter of sensitivity and signal-to-noise ratio is then clearly established and the comparative emptiness of the scale is shown to be due to the absence of signals which should not be there. Stations which on an ordinary set were almost engulfed by a background of

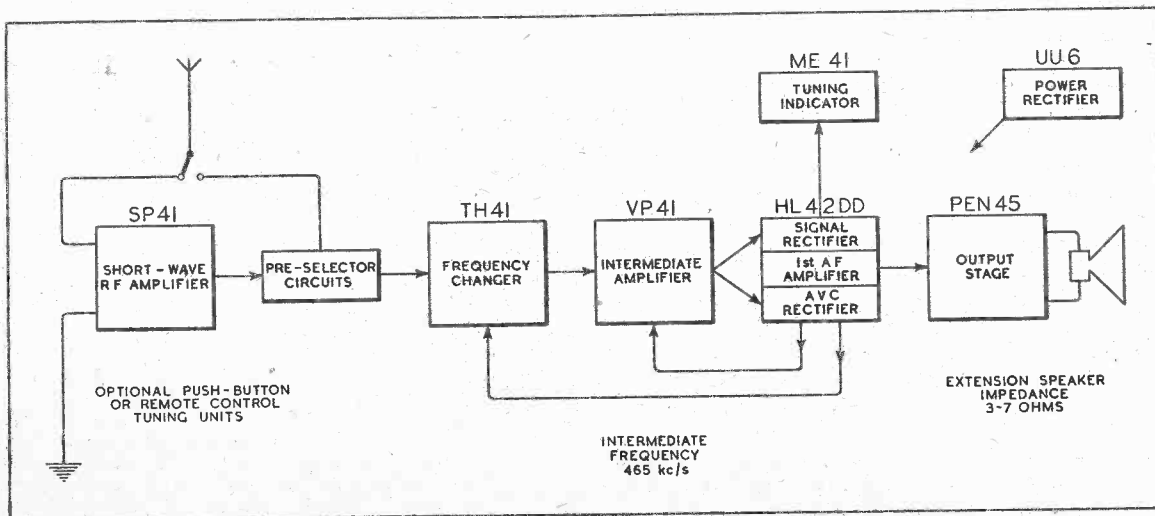

Schematic circuit diagram of the Murphy A76 receiver.

Murphy A76—

CW signals or apparent sideband interference stood out quite clearly on the Murphy set, usually with several clear channels between them and the next stations on either side.

The expansion of each waveband to the full width of the scale makes tuning a real pleasure, and with the aid of the tuning indicator one can adjust for best quality to the exact centre of the modulation as deliberately as one might for a medium-wave station.

As far as frequency stability is concerned, the results fully justify the designers' efforts, and we have no hesitation

WAVERANGES

*Short-wave Bands . . 16, 19, 21, 25, 31,
42 and 49 metres*

Medium-wave Band . . 190-550 metres

Long-wave Band . . 970-2,000 metres

which waveband selection was effected by mechanical location of the tuning condenser, the station settings on the A76 are always accurately repeated, since the cir-

reaching the standard of sets in the Murphy range which have been specially designed for this purpose, is nevertheless admirably suited to long-distance reception. The frequency limitations introduced by the three settings of the combined tone and selectivity control have been well chosen and quality is not unnecessarily thrown away in achieving a quiet background. The conditions under which the set was tested, which would normally call for a severe top cut, were met by the "intermediate" setting of the control and quality that could be enjoyed whether the transmission was speech or music.

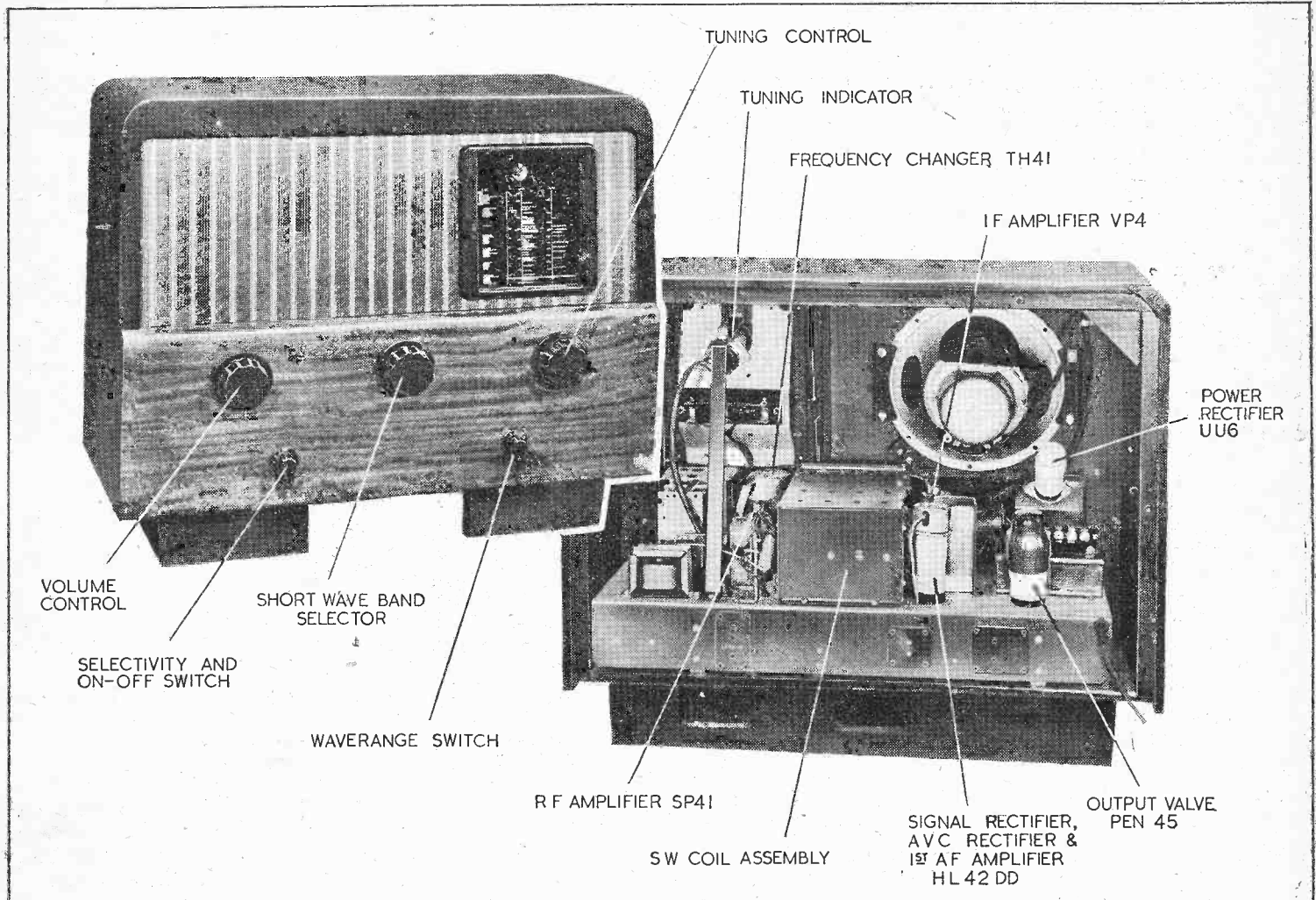

Layout of valves and controls in the Murphy A76. The cabinet has been designed to accommodate an optional press-button or remote control unit in the base.

in saying that from this point of view, as in many others, the A76 sets a new standard of performance for commercially produced short-wave receivers. After listening, say, to an American station for an hour one can switch off and leave the tuning untouched in the certain knowledge that the station will still be there as soon as the set comes to life after being switched on again later in the day. There may be a drift of half a degree on the arbitrary scale between "stone cold" and the equilibrium working temperature, but this is never enough to put the tuning outside the modulation fringe of the station. Unlike an earlier Murphy short-wave double superheterodyne in

circuits are changed throughout by switch contacts.

The medium- and long-wave ranges are by no means subsidiary to the short-waves in this set. They possess all the sensitivity and selectivity required for reliable reception of worthwhile programmes and are quite free from second channel and other self-generated whistles. Rather have the short waves been promoted to the rank of the medium and long waves in entertainment value. The equality of average deflections of the cathode ray tuning indicator on all wavebands gives the user visual proof that this object has been achieved.

Quality of reproduction, while not

The absence of a 13-metre band may be excused if one assumes that most short-wave listening is indulged in during the evening when conditions on this band are not as good as those of higher wavelengths.

Constructional Details.—The four groups of short-wave tuning coils are housed in a subdivided screening box in the middle of the chassis. The short-wave switch spindle passes through the centre of the box, and connections to the separate sections of the switch are as short as it is possible to make them.

A multiple switch of this type requires quite a considerable torque to operate it and the designers have accordingly pro-

Murphy A76—

vided an operating knob of really useful size. It is matched by knobs of similar size for tuning and volume control, both of which are consequently light to the touch. Key-type switch knobs are used for selectivity and main waverange selection.

The principal short-wave station names are arranged in groups down the left-hand edge of the dial and an indicator coupled to the short-wave range switch brackets the group to which the set is tuned. Individual calibrations are made from a 50-division scale covered by an extension of the medium- and long-wave pointer.

The workmanship is well up to Murphy standards and the blue enamel finish of the chassis and principal components is durable.

The base of the cabinet is shaped to receive the push-button or remote control units which are optional accessories to the majority of current Murphy receivers.

Summary.—Ease and precision of tuning, stability in the tuned circuits and freedom from second channel interfer-

ence, have been achieved without sacrificing the essential qualities of range and good signal-to-noise ratio. This is a short-wave "special" with which the ordinary listener may challenge the expert operator and his "communication" set. It places the short-wave range on an equal footing with medium and long waves as a source of entertainment and instruction.

Makers.—Murphy Radio, Ltd., Broadwater Road, Welwyn Garden City, Herts.

PLEASE ORDER NOW

Readers are earnestly requested to instruct their local newsagents to reserve a copy of this journal for them regularly.

This is in order to facilitate distribution arrangements and avoid the risk of failure to obtain copies.

In the interests of the paper itself in these difficult times it is particularly hoped that regular purchase be made from the same newsagent or bookstall each week.

Please see the emergency order form printed in our advertising pages.

the frequency modified by the Doppler principle would be $f(1+u/c)$, and for speeds less than a quarter that of light, there is not much difference between these two results.

Brighton. W. BAGGALLY, M.I.W.T.

"Trophy" Receivers

PETO SCOTT announce that all list prices of "Trophy" communication receivers have been advanced by 10 per cent. Current prices are therefore as follows:—

	£	s.	d.
Trophy 8	13	17	3
Trophy 6	10	19	6
Trophy 3 A.C. Model	6	18	9
Trophy 3 Battery Model ..	6	6	6
Preselector	7	8	6

The cost of additional coils for the Trophy 3 to complete the waverange from 6.2 to 550 metres is 18s. 6d.

Osram Valves

ARRANGEMENTS have been made to ensure regular supplies of Osram valves in all districts. Branches and depots of the General Electric Co., Ltd., in thirty-four towns will maintain stocks of all types.

Simplified Servicing

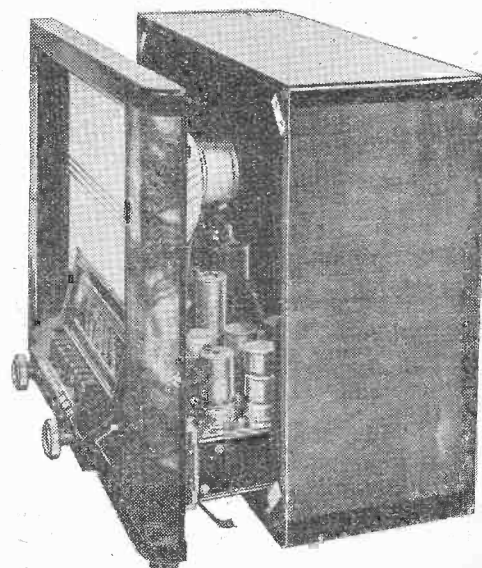

In the Philips Type 735 receiver, the chassis and front panel may be withdrawn from the cabinet as a single unit. By this means ready access is obtained to the interchangeable station dial. The pointer is released by removing one screw, and the dial may be withdrawn sideways after loosening the single clamping screw by which it is held.

Letters to the Editor

The Editor does not necessarily endorse the opinions of his correspondents

Carrying On : A Serviceman's Dilemma

AT such a time as this, there are certain questions which the majority of radio service engineers must be asking themselves. I should like to quote my case as typical.

I am in sole charge of a service department, and, in fact, the only technical man in the firm who is capable of the location of faults in a radio receiver. The value of broadcasting in previous crises was so apparent that it is presumed that the Government will continue the service, both on the score of its utility in rapid dissemination of news and also to help in the maintenance of good spirits. (It is perhaps not fully appreciated outside the retail trade just how "lost" the general public can become without its radio).

The general position, therefore, is this; should the service engineers volunteer (or be conscripted) for duties in the Services it would seem that the radio industry must come to a standstill. To quote my own case, my employer would not sell a receiver he was not prepared to service; indeed the situation would be impossible, for obviously a member of the public could not buy a new receiver every time the one in use developed a fault. We would like to know, therefore:—

(1) Should the service engineer's work be considered of National importance, or should he join one of the Services?

(2) Have the Government made any alternative provision for the servicing of civilian radio? **SERVICEMAN.**

[Wireless servicing is a Reserved Occupation for ages of 30 or above.—Ed.]

Separate Speakers

IN your issue of July 27th your contributor "Diallist" says that he does not know of any set, apart from communication receivers, fitted with a separate speaker.

We have been supplying sets for high-quality reception with separate speakers for many years, and where space and other circumstances permit we invariably recommend the use of a separate speaker.

S. HALFORD,

Halford Distributors, Ltd.

London, W.1.

Free Grid's Speed Indicator

"PARASITE," whose letter was published in *The Wireless World* of August 31st, has not grasped the significance of relativity in relation to the Doppler effect. Does he not know that the supposed expansion of the universe is computed from the lowered frequency of the light from the nebulae caused by their velocity away from the observer?

Suppose for simplicity that the transmitter on the ground radiates a beam of plane waves, and that the aeroplane is moving directly towards the transmitter along the beam. The equation of the waves can be written:

$$E = a \sin p(t-x/c) \dots \dots \dots (1)$$

where E is the electric field strength, $p = 2\pi f$, and c is the velocity of light; all this being relative to the ground station.

Relative to the aeroplane we shall have a similar equation, which we may write:

$$E' = a' \sin p(t'-x'/c) \dots \dots \dots (2)$$

Now the Lorenz transformation from the theory of relativity is:

$$x' = k(x-ut) \quad t' = k(t-xu/c^2)$$

where u is the velocity with which the aeroplane approaches the transmitter, and

$$k = 1/\sqrt{1-u^2/c^2}$$

which when substituted into (2) gives

$$E' = a' \sin pk(1+u/c)(t-x/c)$$

Thus the frequency of the transmitter relative to the aeroplane is not f, but $fk(1+u/c)$.

If the relativity condition were ignored,

Recent Inventions

TELEVISION SYSTEMS

IN the ordinary way the amplitude of a television signal represents the brightness of the corresponding picture element, its frequency determines the size of the element, whilst its phase corresponds to the instantaneous position of the element relative to the picture as a whole.

The invention is based upon the discovery that, in certain cases, these factors of amplitude, frequency and phase can be used to convey information other than that for which they are normally used. In practice, for instance, a finer gradation of light and shade is carried by the radiated wave than it is possible for the eye to appreciate. It is therefore proposed to use some of this superfluous "information" for other purposes.

More particularly, the amplitude of a single current impulse is used to convey simultaneously the separate "brightness" values of a number of different picture elements, thus condensing the frequency band necessary to give a certain quality of picture. Alternatively, it allows a given frequency band to convey more "information" than at present. The transmission of pictures in natural colours is one possible application of the system.

Scophony, Ltd., and F. Okoliczanyi. Application date October 11th, 1937. No. 505653.

TUNING CONTROL

RELATES to the type of set that is tuned under "quiet" conditions, i.e., with the loud speaker out of action, the latter only being switched on when the

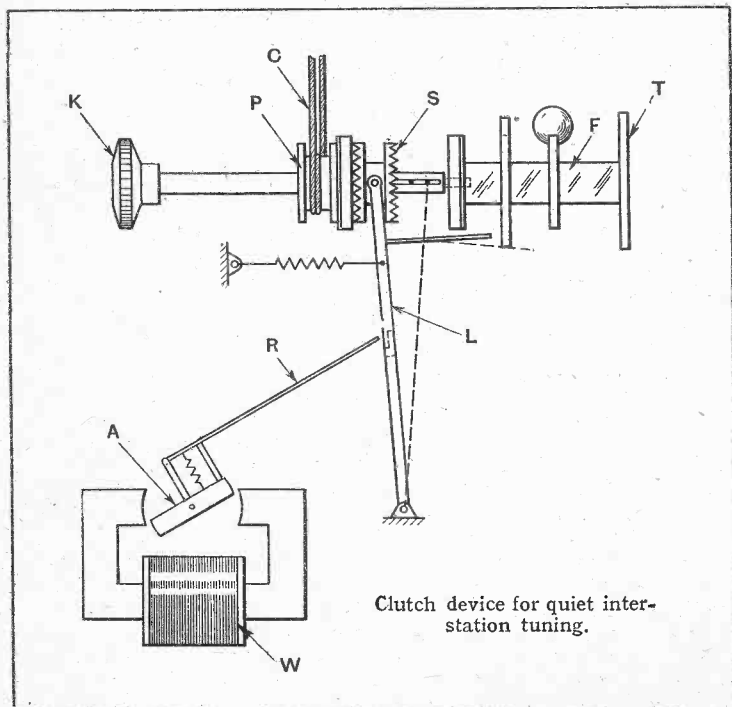

Clutch device for quiet inter-station tuning.

circuits have been accurately tuned to a desired station. The object of the invention is to ar-

Brief descriptions of the more interesting radio devices and improvements issued as patents will be included in this section.

range for the incoming signal to bring the loud speaker into operation, more or less automatically, at the correct tuning point.

As shown in the Figure, the control knob K normally drives the tuning condenser through a pulley P and cord C. When the circuits are in resonance the incoming signal—which passes through a magnet winding W—rotates an armature A so that a rod R throws a pivoted lever L over to the dotted line position. This, in turn, moves a sliding clutch S to the right so that the knob K can no longer drive the pulley P. The tuning therefore "stays put." Further rotation of the knob K then causes a cam T on the sleeve F to bring the loud speaker into circuit.

N.V. Philips Gloeilampenfabrieken. Convention date (Germany), July 26th, 1937. No. 506113.

VOLUME CONTROL IMPROVEMENT

THE current consumption or power taken by a set is, according to this invention, automatically regulated so that it bears a constant ratio to the output from the loud speaker. As shown in the Figure, a diode rectifier D is coupled, through a resistance R and condenser C, to the AF amplifier V. A slider P on the resistance R serves as a volume control.

As the slider P is moved down-

ance R₁ in series with the choke K in the HT supply. Simultaneously, a second slider P₂, also coupled mechanically, increases

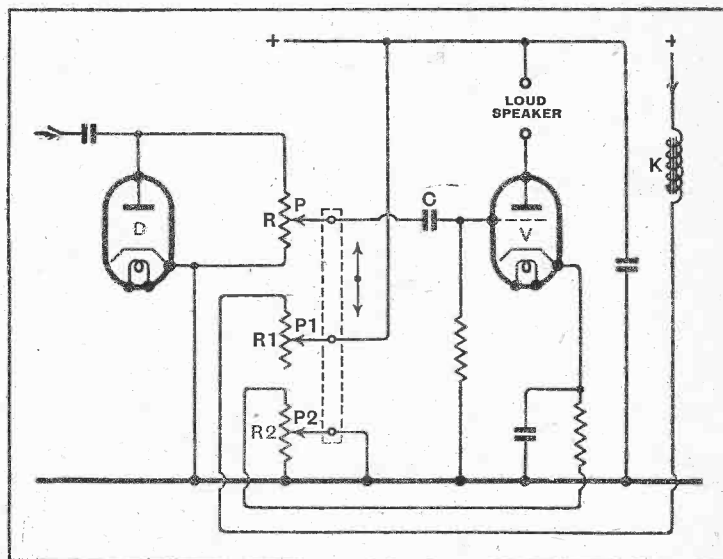

Mechanically linking power supply and volume control.

the negative bias applied by the resistance R₂ to the grid of the amplifier V. Both adjustments serve to reduce the power consumption of the set as the loud speaker volume is cut down. In the same way, more power is automatically fed to the set when the volume of sound is increased.

C. Lorenz, Akt. Convention date (Germany), August 28th, 1937. No. 505878.

AUTOMATIC TUNING CONTROL

THE invention is concerned with automatic tuning systems, particularly for car radio, of the kind in which an electric motor is used to rotate the main tuning control. It is pointed out that if the motor is fast-moving it is difficult to stop it at the correct tuning point for the station selected. On the other hand, if the motor is slow-moving, it takes a disagreeably long time to tune between two stations which happen to be widely separated in frequency.

It is therefore proposed to make a compromise by so arranging matters that the motor moves rapidly "between stations," but automatically slows up as it approaches the selected station. This object is attained by passing the DC anode current from one or more of the amplifiers through a saturable choke inserted in series with the field windings of the motor. As the critical tuning point is approached the effect of the AVC voltage cuts down the DC component of the anode cur-

rent, and so automatically reduces the speed of the tuning motor.

Hazeltine Corporation (assignees of N. P. Case). Convention date (U.S.A.) October 22nd, 1937. No. 505820.

BLIND LANDING BY RADIO

A GUIDING beam for an aeroplane can be formed by erecting a dipole aerial some two or

three wavelengths above ground, so that the direct radiation combines with that reflected upwards from the earth's surface to produce a "club-shaped" field down which the pilot glides. In practice, it is found that a single dipole aerial produces a field in which "lobes" of high field strength are interspersed with "anti-lobes" or intervals where the field strength sinks to a minimum.

The presence of these "silent" zones is troublesome and misleading to the pilot, and it is the object of the invention to eliminate them. For this purpose the main aerial is combined with a second dipole, separated from the first by half a wavelength in the vertical plane. This, too, radiates a similar field in which lobes of maximum strength are separated by silent zones, but when the two aerials are spaced apart in the way described the silent zones of one coincide with the maximum lobes of the other, and vice versa, so that the resulting field is of uniform strength.

R. J. Berry (communicated by C. Lorenz Aktiengesellschaft). Application date May 24th, 1938. No. 504163.

The British abstracts published here are prepared with the permission of the Controller of H.M. Stationery Office, from specifications obtainable at the Patent Office, 25, Southampton Buildings, London, W.C.2, price 1/- each.

CLASSIFIED ADVERTISEMENTS

NOTICES

THE CHARGE FOR ADVERTISEMENTS in these columns is

12 words or less, 3/- and 3d. for every additional word.

Each paragraph is charged separately and name and address must be counted.

SERIES DISCOUNTS are allowed to Trade Advertisers as follows on orders for consecutive insertions, provided a contract is placed in advance, and in the absence of fresh instructions the entire "copy" is repeated from the previous issue: 13 consecutive insertions 5%, 26 consecutive, 10%; 52 consecutive, 15%.

ADVERTISEMENTS for these columns are accepted up to **FIRST POST ON MONDAY MORNING** (previous to date of issue) at the Head Offices of "The Wireless World," Dorset House, Stamford Street, London, S.E.1, or on **SATURDAY MORNING** at the Branch Offices, 8-10, Corporation Street, Coventry; Guildhall Buildings, Navigation Street, Birmingham, 2; 260, Deansgate, Manchester, 3; 26a, Renfield Street, Glasgow, C.2.

Advertisements that arrive too late for a particular issue will automatically be inserted in the following issue unless accompanied by instructions to the contrary. All advertisements in this section must be strictly prepaid.

The proprietors retain the right to refuse or withdraw advertisements at their discretion.

Postal Orders and Cheques sent in payment for advertisements should be made payable to **ILIFFE & SONS Ltd.**, and crossed **& Co.** Notes being untraceable if lost in transit should not be sent as remittances.

All letters relating to advertisements should quote the number which is printed at the end of each advertisement and the date of the issue in which it appeared.

The proprietors are not responsible for clerical or printers' errors, although every care is taken to avoid mistakes.

NUMBERED ADDRESSES

For the convenience of private advertisers, letters may be addressed to numbers at "The Wireless World" Office. When this is desired, the sum of 6d. to defray the cost of registration and to cover postage on replies must be added to the advertisement charge, which must include the words Box 000, c/o "The Wireless World." All replies should be addressed to the Box number shown in the advertisement, c/o "The Wireless World," Dorset House, Stamford Street, London, S.E.1. *Readers who reply to Box No. advertisements are warned against sending remittances through the post except in registered envelopes: in all such cases the use of the Deposit System is recommended, and the envelope should be clearly marked "Deposit Department."*

DEPOSIT SYSTEM

Readers who hesitate to send money to advertisers in these columns may deal in perfect safety by availing themselves of our Deposit System. If the money be deposited with "The Wireless World," both parties are advised of its receipt.

The time allowed for decision is three days, counting from receipt of goods, after which period, if buyer decides not to retain goods, they must be returned to sender. If a sale is effected, buyer instructs us to remit amount to seller, but if not, seller instructs us to return amount to depositor. Carriage is paid by the buyer, but in the event of no sale, and subject to there being no different arrangement between buyer and seller, each pays carriage one way. The seller takes the risk of loss or damage in transit, for which we take no responsibility. For all transactions up to £10, a deposit fee of 1/- is charged; on transactions over £10 and under £50, the fee is 2/6; over £50, 5/-. All deposit matters are dealt with at Dorset House, Stamford Street, London, S.E.1, and cheques and money orders should be made payable to Iliffe & Sons Limited.

SPECIAL NOTE.—Readers who reply to advertisements and receive no answer to their enquiries are requested to regard the silence as an indication that the goods advertised have already been disposed of. Advertisers often receive so many enquiries that it is quite impossible to reply to each one by post. When sending remittances direct to an advertiser, stamp for return should also be included for use in the event of the application proving unsuccessful.

SOUND SALES GO INTO ACTION!

As already intimated to our Readers **SOUND SALES** have evacuated from Marlborough Road, Upper Holloway, London, N.19, to **WEST STREET, FARNHAM, SURREY**, where they are concentrating with all the resources at their disposal on Government Contracts.

At the same time we are surprised to receive so many orders and enquiries from people who are quick to realise that Radio of any sort, better still "QUALITY RADIO" in which we specialise, may represent their main source of information and entertainment.

We are in a position to book orders for all **SOUND SALES** products, and trust we may have the pleasure of forwarding our latest catalogue and technical manual. **PRICE 6D.**

Specified by  the Experts

SOUND SALES

WEST STREET, FARNHAM, SURREY

Telephone: **FARNHAM 5215**

NEW RECEIVERS AND AMPLIFIERS

* **CHALLENGER** Range for 1940.

CHALLENGER RADIO CORPORATION.—2d. stamp for illustrated catalogues of battery, battery-mains, car radio, and mains receivers; 65/- to £28; sale list also available.

CHALLENGER RADIO CORPORATION, 31, Craven Terrace, London, W.2. Nearest point, Lancaster Gate Station. [8872]

RADIO CLEARANCE, Ltd.

All Lines Previously Advertised Still Available.

All Orders Over 5/- Carriage Free; under this amount sufficient postage must be included with order.

All Enquiries Must Enclose 1½d. Stamp.

RADIO CLEARANCE, Ltd., 63, High Holborn, W.C.1. Holborn 4631. [8896]

ARMSTRONG Co. Can Give Delivery of Practically all 1940 Radio Chassis

ARMSTRONG Recommend the Two Following Economically Priced, powerful chassis, suitable for receiving North and Scottish Emergency Transmitters.

ARMSTRONG Model AW38, 8-valve all-wave radio-gram chassis, with 6 watts push-pull output; price 8 gns.

ARMSTRONG Model AW93PP 9-valve All-wave Radio-gram Chassis, with radio-frequency pre-amplifier and 8 watts push-pull output; price 10 gns.

ARMSTRONG Models AW38 and AW93PP Are Both Efficient on the Important 16, 19, 25, 30 and 50 metre short wave bands.

ARMSTRONG Have Illustrated Catalogue Describing Above Chassis and Many Others of Equal Interest.

ARMSTRONG Co. Announce that, in accordance with their policy of fair trading, prices of chassis will not be increased until absolutely necessary.

ARMSTRONG MANUFACTURING Co. (Head Office), Warrlers Rd., Holloway, London, N.7. [8883]

PUBLIC ADDRESS

TANNOY 25-watt Amplifier, Ad-on-Unit, A.C. mains, complete; £10.—Easco, 18w, Brixton Rd., S.W.9. [0643]

"**PARTRIDGE P.A. Manual.**" free to trade, from N. Partridge, B.Sc., A.M.I.E.E., King's Buildings, Dean Stanley St., London, S.W.1. [0631]

PUBLIC Address Contractors Can Hire P.A. Vans, loud speakers, microphones and equipments of all types from Hire Dept., Gramphon Reproducers, Ltd., Kew Gardens, Surrey. Tel.: Richmond 1175-6-7. [0618] [0531]

PUBLIC ADDRESS

VORTEXION P.A. Equipment.

IMITATED, but unequalled.

WE Invite You to a Demonstration.

A.C.-D.C. Dance Band Amplifier, 10 watts output, complete in case, with moving coil microphone, speaker and cables, weight 22lb.; 12 gns.

A.C.-20 15-20-watt Amplifier, 38-18,000 cycles, independent mike and gram, inputs and controls, 0.037 volts required to full load, output for 4, 7.5, and 15 ohms speakers, or to specification, inaudible hum level, ready for use; 8½ gns. complete.

C.P. 20 12-volt Battery and A.C. Mains Model, as used by R.A.F., output as above; 12 gns.

A.C.-20, in portable case, with Collard motor, Piezo pick-up, etc., £14; C.P.20 ditty, £17/17.

50-WATT Output 6L6s, under 60-watt conditions, with negative feed back, separate rectifiers for anode screen and bias, with better than 4% regulation level response, 20-25,000 cycles, excellent driver, driver transformer, and output transformer matching 2-30 ohms impedance electronic mixing for mike and pick-up, with tone control, complete with valve and plugs; £15.

COMPLETE in Case, with turntable, B.T.H., Piezo pick-up and shielded microphone transformer; £20.

80-WATT Model, with negative feed back; £25, complete.

120-WATT Model, with negative feed back; £40, complete.

250-VOLT 250 m.a. Full Wave Speaker field supply unit; 25/-, with valve.

All P.A. Accessories in Stock; trade supplied.

VORTEXION, Ltd., 182, The Broadway, Wimbledon, S.W.19. Phone: Lib. 2814. [8241]

NEW LOUD-SPEAKERS

BAKERS New Corner Horn Speakers, triple cone versions; from 29/6, and surplus speaker bargains. —Bakers Selhurst Radio, 75, Sussex Rd., South Croydon. [8728]

CABINETS

A CABINET for Every Radio Purpose.

CONVERT Your Set into a Radiogram at Minimum Cost; surplus cabinets from noted makers under cost of manufacture (undrilled); 30/- upwards; motors at wholesale prices.

"**FITA-GRAM**" Cabinet, 31x17x15, 21/-.

UNDRIILLED Table Console and Loud-Speaker Cabinets from 3/6.

INSPECTION Invited; photos loaned to country customers.

H. L. SMITH and Co., Ltd., 289, Edgware Rd., W.2. Tel.: Pad. 5891. [0485]

ARMSTRONG ARE CARRYING ON AS USUAL!

We can give immediate delivery of all 1940 chassis advertised during August including the two following economically priced powerful models suitable for receiving North and Scottish Emergency Transmitters.

Model AW38 8-V. ALL-WAVE R-G. CHASSIS with 6 watts Push-Pull Output - Price 8 Gns.

Model AW93 PP. 9-V. ALL-WAVE R-G. CHASSIS with RF Pre-amplifier and 8 watts PP. Output. Price 10 Gns.

7 DAYS' APPROVAL—12 MONTHS' GUARANTEE Illustrated Catalogue sent upon request.

ARMSTRONG MANUFACTURING CO. WARRLERS ROAD, HOLLOWAY, LONDON, N.7 (Adjoining Holloway Arcade.) Phone: NORTH 3213

L-R-S

intend carrying on the good work of supplying Quality Radio Equipment.

ARMSTRONG CHASSIS

PORTABLE A.R.P. RECEIVERS and other reliable radio apparatus are available as usual on our very **CONVENIENT TERMS.**

Write for quotation and full details.

—PLEASE NOTE OUR TEMPORARY ADDRESS—

LONDON RADIO SUPPLY COMPANY

"DENWYN," OXENDEN WOOD RD., CHELSFIELD, KENT

ELECTRADIX

Aids for Home, Office, Works, etc.

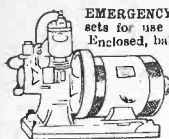

EMERGENCY 12-VOLT LIGHTING SETS. "V" Dynamo sets for use with 12-volt battery, 12/16 volts, 10 amps. Enclosed, ball bearings, Vee pulley 35/-. Switchboard for same with ammeter, max.-min. auto cut-out and in. Main Switch and Fuses. The set 65/-. Generator only, 35/-. C.Z. Meter, 7/6. 30 AMP. 1 k.w. Model T.B. Generator, 12/16 volts, 45/-. A.C.-D.C. Crypto Constant Potential Charger for 220 volts single phase with output, D.C. of 8 volts 50 amps. and 100 volts 1 amp.

ELECTRIC PUMPS, for A.C. or D.C., 12 v. to 230 v. Centrifugal all-bronze pump, throws 120 galls. per hour, 6 ft. Caravans, Bungalows and Boats, 67/8. Larger pumps for draining shelters, dug outs etc., £5.10.



A.R.P. WARDENS and Others.—Portable 'Phones in case, with handcomb, 45/-. Pocket Headphones, W.D., all leather headband, strap and cords, 2/6 pair. Wireless type with aluminium headbands, 2/9. 4,000 ohms, 4/6. Unbreakable Govt. Cable, 55/- mile. Portable Day and Night Signal Lamps. Aids or Lucas. Army type. Hand or tripod. Mains Bells for warnings, D.C. or A.C. Hand Generators for field or emergency transmitters (D.C.), 800 volts and 1,500 volts. Morse Inker Recorders for use when 'phone unsuitable, makes code message record on paper tape. Walnut case, as new, portable field type, spring driven, with taper key and meter indicator, £7. Open G.P.O. type with tape reel in base, £5/10/-. A few soiled and incomplete, with perfect spring drive, 25/-. Dry cells work Inkers, no radio needed. G.P.O. Sounders, 7/6. 3-colour light switch box with Morse Key fitted for code signals, 4/6. D.C. Generators. 500, 800 and 1,500 volts. Electric Motor Pumps, will deliver 120 galls. per hour 6ft. on a 12 v. car battery or mains, A.C. or D.C., £3/7/6. Electric Blowers, Foul Air Exhausters, 25/-.

ALARM BELLS.—BELLS for all purposes. House, wall and table 'phone bells for battery and mains. Single stroke per push Works Bells. Call Buzzers. Fire Alarm Bells and Pushes. First-class British, cheap.

WIND DYNAMO. Start generating at 300 revs. up to 2,000 revs., 8/10 amps., ball-bearing, enclosed type, 35/-.

LUCAS AERO, 9/12 volts, 250 watts D.C. with enclosed Automatic Cut-out. Used on aircraft for L.T. supply to lighting, heating and wireless. Cost £15. Rate 25/-.

H.T. DUAL, cost £12. 600 volts, 100 m.a., and L.T. 6 volts, 5 amps. Size 20/-.

DUG-OUT CRYSTAL SETS. Model B, Pol. Mah. case 9in. x 10in., 2 tuning condensers, plug-in coils, Permanent Detector, 7/6. Phones, 4/6.

YOU MUST KEEP YOUR BATTERY PREPARED !!! Battery Charging on A.C. Mains. The A.C. NITDAX will keep your battery fit without attention. Model N/A6, 100/250 volts A.C. and D.C. 6/8 volts 1 amp., 15/-; Model N/B6, 100/250 volts to D.C. 6/8 volts 1 amp., 25/-; Model N/C6, 100/250 volts to D.C. 6/8 volts 2 amps., 35/-; Model N/D12, 100/250 volts to 12 volts 1 amp., 32/-; Ditto, 12 volts 2 amps., with 6-volt tap, 55/-; 5 amp., £4/10/-.

EMERGENCY PARCEL of 10 lb. o' components: resistances, tubulars, micas, variables, wire sleeving, vol. controls, coils, magnets, chokes, switches, mouldings, terminals, etc., post free; 10 lb., 5/-.

Over 1,000 other Bargains in our enlarged Illustrated List "W"

ELECTRADIX RADIOS

218, UPPER THAMES STREET, LONDON, E.C.4

Telephone: Central 4611



Said that veteran radio-man, Pace, "That crystal set in its glass case May make you amused, But since FLUXITE I used, It's the first of a very long race!"

See that FLUXITE is always by you—in the house—garage—workshop—wherever speedy soldering is needed. Used for 30 years in Government works and by leading engineers and manufacturers. Of Ironmongers—in tins, 4d., 8d., 1/4 and 2/8. Ask to see the FLUXITE SMALL-SPACE SOLDERING SET—compact but substantial—Complete with full instructions, 7/6. Write for Free Book on the art of "SOFT" SOLDERING—and ask for leaflet on CASE-HARDENING STEEL and TEMPERING TOOLS with FLUXITE.

TO CYCLISTS! Your wheels will NOT keep round an 1 true unless the spokes are tied with fine wire at the crossings AND SOLDERED. This makes a much stronger wheel. It's simple—with FLUXITE—but IMPORTANT

THE FLUXITE GUN

is always ready to put Fluxite on the soldering job instantly. A little pressure places the right quantity on the right spot and one charging lasts for ages. Price 1/6 or filled 2/6.

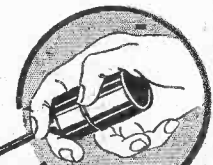

ALL MECHANICS WILL HAVE
FLUXITE
IT SIMPLIFIES ALL SOLDERING

FLUXITE LTD., Dept. W.W., DRAGON WORKS, BERMONDSEY ST., E.C.1

TRANSMITTING APPARATUS

G5NI for Communication Receivers, American and British valves, short-wave equipment; largest stocks in the country; National Agents.—44, Holloway Head, Birmingham. [0531]

DYNAMOS, MOTORS, ETC.

ALL Types of Rotary Converters, electric motors, battery chargers, petrol-electric generator sets, etc., in stock, new and second-hand.
A.C.-D.C. Conversion Units for Operating D.C. Receivers from A.C. Mains, 100 watts output, £2/10; 150 watts output, £3/10.
WARD, 46, Farringdon St., London, E.C.4. Tel.: Holborn 9703. [0518]

ELECTRADIX Rotary Converters for A.C. Radios on D.C. Mains; alternators, 50 to 500 cycles; mains motors and motor generators for 1 to 600 cells; petrol engines and switchgear.—218, Upper Thames St., London, E.C.4. [0619]

VALVES

SPECIAL Line of Rogers and Majestic Tubes, types 551, 227, 551s, 55s, 6B7, 56 and 58, 2B7, 6 red 5 and 53; 5/6.

ALL Types of American Tubes in Stock of Impex and Arcturus makes at competitive prices.
WE Can Also Supply a Full Range of Guaranteed Replacement Valves for Any British non-ring, American or Continental type at an appreciably lower price.
SEND for Lists of These, and also electrolytic condensers, line cords, resistances, etc.
CHAS. F. WARD, 46, Farringdon St., London, E.C.4. Tel.: Holborn 9703. [0452]

METROPOLITAN RADIO SERVICE.—Special offer. American valves, in maker's cartons, 3/- each, Octals, 3/6 each; American valves, first grade, in all types; trade supplied.—1021, Finchley Rd., N.W.11. Speedwell 3000. [0436]

TEST EQUIPMENT

£9—Cossor cathode ray oscilloscope, two only, new condition, cost £23; 4in. tube, variable Luvean time-base; also two Philco valve testers, new, £6.—Mr. Charles, 146, Cambridge St., S.W.1. Vic. 7902. [8889]

COMPONENTS

SECOND-HAND, CLEARANCE, SURPLUS, ETC.

RYALL'S RADIO, 280, High Holborn, London, W.C.1, offer new goods, post free.

ELLIPTICAL Speakers, Celestion, suitable Ekco replacements, 750 and 1,250 ohms, less transformers, speech 25 ohms, new, handle 8 watts, carry up to 120 m.a.; 5/6 each.

SPEAKERS, pairs, brand new, elliptical cone speakers, made by first class firm, quality of reproduction outstanding, push-pull pentode transformer, fields 325 ohm for smoothing choke, 8,600 as bleeder, circuit available, handle 10-15w.; 14/- pair.

HEAVY Duty Mains H.F. Chokes, Goltone, 75w. high inductance type, 1/6; 180w. low inductance type, 1/-.

MAINS Transformers, drop through chassis type, top cover with mains adjustment, input 200-250v., outputs 350-350, 80 m.a. 4v. 2 1/2a., 4v. 4.5 amp., heavy jobs, 6/9 each.

MAGNAVOX 7in. Cone Speakers (8in. overall), ribbed pattern, ideal replacement speakers, 2,000 ohms pentode transformers; 7/-, new.

SATOR 1/2meg. Pots with Switch, 1/3 each, 7/9 dozen; 10,000 ohm broad base tone control type, less switch, 1/3 each, 6/9 dozen.

AMPLIFIERS for A.C. 200-250v. Input, 3-stage single 6L6 output, with pair energised elliptical speakers, and Ferranti output transformer, output 12 watts; 47/6, all wired complete with valves and speakers.

ZENITH Insulated A.C.-D.C. Resistances, 0.3 amp., 550 ohms, tapped 380-100-70, ex-Ferranti, 1/3 each, 6 for 5/-; ditto, 670 ohms, tapped 500-70-30 ohms, 1/9 each, 6 for 9/-; ditto, 150 ohms, tapped, 1/3 each; all insulated types.

ELECTROLITICS.—Ferranti 8x8 cardboard, common neg. 500v. peak, 1/9 each, 6 for 9/-; size 4 1/2in. x 1 1/2in., B1, 20x20mf. at 350v. 25x25v., 1/3; size 3in. x 2 1/2in., B1, 12x8 at 400v. P. 25x25v., 1/3; Plessey 30x 8x2, 300v. wkg., 1/6 each, 12/- dozen.

B.1 0.05 Condensers, N.1, 350v. wkg., 1/3 dozen, 9/- gross; B1 0.25 condensers, 350v. wkg., 2/- dozen, 4/6 per three dozen, tubulars.

SATOR 1,500v. Test Tubular Condensers, assorted, equal S numbers, 0.002-3.5, 0.001, 0.03, 0.05, 0.002-3, mica; all at 5 for 2/6.

ASSORTED Resistances, 50 for 2/6; 1-watt carbon, U.S.A. make, reasonable assortment given, sizes approx. 450-12,000-17-60-70-90-120 thousand ohms.

PUSH Back Wire, 18g., 50 yards, 3/6; Systoflex 1 1/2 min., 1/2 gross, 5/-; twin screened 2x14-36, British made, 12 yards, 2/6; minimum quantities.

REX Type Switches, 4B, 2P, 4w., with shorting plate on 5 switches, 2/6 each, length 7in., spindle 2in.; ditto, 3w. 4P, 3B., 1/6; 3w. 3P, 3B., with shorting plate, 1/6; 3w. 2P, 4B., 1/6; any combinations of this item supplied; screens, 3in. x 3in. x 3in., 5 for 1/3.

EPICYCLIC Drives, Polar ex-Ferranti, long spindles; 1/3 each, or 21/- per 100, minimum, all new.

POLAR V.P. Drives, less escutcheons, 1/9; Plessey 2-gang fully screened condensers with top trimmers, short spindles, 2/9 each, or 20/- per dozen.

MANSBRIDGE Type Condensers, "Static" 400v. wkg., 4x4x1, 2/4 each; Dubilier 1.5 blocks, 250v. wkg., divided 0.5-0.5-0.25-0.25, 1-3, 4/9 dozen.

TRIMMERS on Porcelain Plessey, double and single, 50-100-200-160 ohm, approx.; 50 for 2/6; special price quantities.

APPROX. 800 Cossor 3-gangs, 600 Plessey 3-gangs, 8,000 Missner double trimmers for I.F.s and 8,000 ohm I.F. cans to fit, approx. 2,000 Ferranti screened grid coils, and 3,000 aerial transformers. [8894]

RADIOMART

G5NI (BIRMINGHAM) LTD.

THE SHORT-WAVE SPECIALISTS

SPECIAL OFFER!!!
Fully shrouded Transformer by America's largest manufacturer. While they last.

All 280 v. primary and fully impregnated.
T28708—375/375 v. 150 m/A., 6.8V3A, 2.5V5A, 5V3A 15/-
T19610—350/350 v. 150 m/A., 2.5V5A, 2.5V3A, 5V3A 12/6
T7236—375/375 v. 120 m/A., 6.8VCT, 4A, 5V3A 10/6
T7326—350/350 v. 100 m/A., 6.8VCT, 3A, 5V3A 8/6
T7307—350/350 v. 80 m/A., 6.8VCT, 3A, 5V3A 7/6
T7000—320/320 v. 38 m/A., 6.8V4A, 5V3A 7/6
T6025—320/320 v. 30 m/A., 2.5V6A, 5V3A 7/6
T464910—10V1A Primary Tapped 110—250 v. 5/6
T11818—110/230 v. 500 watt Auto Transformer 29/6

The following chokes are intereaved and impregnated.
T7007—250 m/A., 135 ohms, 20-8 Hy., cadmium shrouded 12/6
T7007A—150 m/A., 250 ohms, 30-12 Hy., cadmium shrouded 12/6
T6025—20 Hy., 500 ohms, unshrouded 4/11
30 m/A., 15 Hy. 250 ohms 1/11

HEAVY DUTY TRANSFORMER for: modals, bells, etc., 6 v. 3 a., 2/3 4 m.f., 1,500 v. test 500 v. wkg. oil filled condensers, 2/-.

HEAVY DUTY Mains Transformer, worth 45/-, 350-350, 150 m/A. 4 v. 2.5 a., CT, 4 v. 6 a., CT, 12/3; 300-300 v., 80 m/A., 4 v. 3 a., CT, 4 v. 2 a., CT, 6/6. Moving Coil Speaker Transformers, power, pentode or push pull, 1/11. WB Heavy duty ditto 2/11.

GANG CONDENSERS with Airplane Dial, 3 and 30-1. Cost 35/-, Pent only, 4/11. Utility, 7/6. Microdials, 3/6.

W.D. 8in. PERMANENT MAGNET SPEAKERS AT ONE-THIRD COST Extension Type (no Transformer), 8" L.L. Standard Type (with Transformer) 10/6. Energised 8", 1200 ohms with Transformer, 6/11.

PUSHBACK Wire, 6 yds. 6d., heavy 9d., Resin-cored Solder, 6/6. 6d.; Screened Flex, single, 6d. yd.; twin, 9d. yd. Assorted Solder Taps, 6d. packet. Humdimmers 6d. each. Central tap pots, all sizes, 1/6.

switched, 2/-; tubular fuses, 2d. Milliameters, 25 m.a., upwards 5/9. **VALVES**—Reliable replacements for all types, British and American, showing saving of over 50 per cent.

OUR NEW 66-PAGE MANUAL packed full of valuable information. Communication receivers, transmitters, etc., 7/6, post free.

THE NEW RAYMART CATALOGUE shows dozens of New Short-wave Components and is yours for 1/4, post free. **TRADE ENQUIRIES** invited for all types of communication equipment, transmitters, receivers, etc.

RADIOMART

G5NI (Birmingham) Ltd. Telephone: MIDland 3254

44, HOLLOWAY HEAD, BIRMINGHAM

ANNOUNCEMENT

My friends experiencing difficulty in obtaining Transformers and Chokes from their usual source of supply, owing to Government orders taking priority, should get into touch with us at once. We are in a position to give immediate delivery and invite your enquiries.

N. PARTRIDGE

B.Sc., A.M.I.E.E.
KING'S BLDGS., DEAN STANLEY ST., LONDON, S.W.1. 'Phone: VICTORIA 5035

ENGINEERS! ARE YOU EARNING LESS THAN £10 PER WEEK?

If so, you cannot afford to carry on without reading our 268-page Handbook. The book explains clearly and definitely many ways of carving out a successful career. Among other things it explains the Services of our unique Appointments Department: outlines Home-Study Courses in all branches of Civil, Mechanical, Electrical, Motor, Aero, Wireless, "Talkie" Engineering, Building, Govt. Employment, etc., and gives details of P.Sc., A.M.I.C.E., A.M.I.E.E., A.M.I.Mech.E., A.M.I.A.E., A.M.I.W.T., A.M.I.R.E., G.P.O., MATRIC., and all Exams. We Guarantee—"NO PASS—NO FEE." Whether you be an old hand or a budding apprentice get this look-o-day, FREE and POST FREE.
BRITISH INSTITUTE OF ENGINEERING TECHNOLOGY
367, Shakespear House, 17/13, Stratford Place, London, W.1.

We do quite a lot of business making up transformers to customers own specifications; but we have a standard list. May we send you a copy?
W. BRYAN SAVAGE LTD
Westmoreland Rd., London, N.W.9. 'Phone: Colindale 7131

BUSINESS AS USUAL!

PREMIER

RADIO

PREMIER BATTERY CHARGERS. Westinghouse Rectification. Complete. Ready for use. To charge 2 volts at 1 amp., 10/-; 6 volts at 1 amp., 16/6; 6 volts at 1 amp., 19/6; 12 volts at 1 amp., 21/-; 6 volts at 2 amps., 32/6.

TRIAD U.S.A. VALVES

Reduced Prices maintained while stocks last. All goods previously advertised still available.

NOW READY

PREMIER 1940 CATALOGUE
111 PAGES PRICE 6d.

Over 20 Pages of British and U.S.A. Valve Data, Receivers, Amplifiers, Components.
GET YOUR COPY TO-DAY!

ALL POST ORDERS TO: Jubilee Works, 167, Lower Clapton Road, London, E.5. *Armerst 4723*
CALLERS TO: Jubilee Works, or our NEW PREMISES, 169, FLEET STREET, E.C.4 *Central 7833*
or 50, High Street, Clapham, S.W.4. *Macaulay 2381*

THE INSTITUTE OF WIRELESS TECHNOLOGY
(Founded in 1925. Incorporated).

PROFESSIONAL MEMBERSHIP

The advantages of professional membership are open to all qualified wireless engineers.

Full information, with syllabus, may be obtained from the Assistant Secretary, Institute of Wireless Technology, 25, Firs Drive, Palmers Green, London, N.13.

INDEX TO ADVERTISEMENTS

PAGE

Anglo-American Radio (& Motors), Ltd.	1
Armstrong Manufacturing Co.	1
Automatic Coil Winder Co., Ltd.	1
Barrus, E. P., Ltd.	3
Belling & Lee, Ltd.	3
Birmingham Radiomart G5N1	2
British Institute of Engineering Technology	2
British Insulated Cables, Ltd. Inside Back Cover	
British Mechanical Productions, Ltd.	2
British Rola	2
Capstan Cigarettes	
Chloride Electrical Storage Co., Ltd.	
Edison Swan Electric Co., Ltd.	2
Electradix Radios	2
Evrizone Radio & Television Co., Ltd.	2
Fluxite, Ltd.	2
General Electric Co., Ltd. Inside Front Cover	
Goodmans Industries, Ltd.	
Gramplan Reproducers	
Healey & Baker	
Henley, W. T., Telegraph Works Co., Ltd.	
Institute of Wireless Technology	3
International Correspondence Schools	
Jackson Bros. (London), Ltd.	
Lockwood & Co.	1
London Radio Supply Co.	1
Marconi-Ekco Instruments, Ltd.	
Masters, C. E.	
McClure, John, Ltd.	
Pamphonic Reproducers, Ltd.	2
Partridge, N.	2
Player's Cigarettes Inside Back Cover	
Premier Supply Stores	3
Quartz Crystal Co.	
Rothermel, R. A. Ltd.	
Salford Electrical Instruments, Ltd.	2
Savage, W. Bryan, Ltd.	1
Sound Sales, Ltd.	1
Stratton & Co., Ltd.	
Summers, John, & Sons, Ltd.	
United Insulator Co., Ltd.	
Universal Electric	
Varley, Ltd.	
Voigt Patents, Ltd.	
Vortexion, Ltd.	
Webb's Radio	
Welburn Radio, Ltd.	
World Radio	

COMPONENTS—SECOND-HAND CLEARANCE, SURPLUS, ETC.

RADIO CLEARANCE, Ltd.
ALL Lines Previously Advertised Still Available.
ALL Orders Over 5/- Carriage Free; under this amount sufficient postage must be included with order.
ALL Enquiries Must Enclose 1/4d. Stamp.
RADIO CLEARANCE, Ltd., 63, High Holborn, W.C.1. Holborn 4631. 18895
PREMIER SUPPLY STORES.
PLEASE See Our Displayed Advertisement on this page. 10488
COUPLPHONE RADIO. Ormskirk.—"Astatic" crystal pick-up; £1/1; Collaro motors; 1/4d. stamp catalogues. 18892
VAUXHALL.—All goods as previously advertised still available; write for free list.—Vauxhall Utilities, 163a, Strand, W.C.2. 18727
SOUTHERN RADIO, 46, Lisle St., London, W.C. Gerard 6653.—Stocks of receivers and replacement components as previously advertised. 18548
MAINS RADIO DEVELOPMENT COMPANY Continue their Super Service Under Management of Proprietor's wife; stamp for list 230; note new address, 52a, Church Crescent, Muswell Hill, N.10.
ERIE Unused Resistors, 1-watt, all sizes, 3d. each, 2/6 dozen; 2-watt, 6d.
CENTRALAB Latest Long Spindle Potentiometers, all sizes, 2/-; with switch, 2/3.
TUBULAR Condensers, new, 400v.w., non-inductive, best make, all sizes to 0.1 mid.; 4d.
FIFTY Wire-end N.S.F. Resistors, grand assortment, 2/6; Chix valve-holders, 5, 7-pin, 3d. 18893

REPAIRS AND SERVICE

GUARANTEED Repairs, Any Transformers, choke, motor armature, converter, dynamo, etc., keenest prices, immediate quotation, prompt, dependable service.—See below.
LT.P. (LONDON TRANSFORMER PRODUCTS, Ltd), Willesden, N.W.10. Willesden 6486 (3 lines). 18892
MAINS Transformer Service, Repairs, rewinds, or construction to specification of any type, competitive prices and prompt service.—Sturdy Electric Co., Dilton, Newcastle-on-Tyne. 10516
LOUND-SPEAKER Repairs, British, American, any make, 24-hours' service; moderate prices.—Sinclair Speakers, Pulteney Terrace, Copenhagen St., N.1. 10590
METROPOLITAN RADIO SERVICE.—Guaranteed repairs to American and British receivers; American valves, service parts and rewinds; trade supplied.—1021, Finchley Rd., N.W.1. Speedwell 3000. 10435
REPAIRS to Moving Coil Speakers a Speciality; cones and coils fitted, fields altered; prices, including eliminators, quoted; loud speakers, 4/-; L.F. and output transformers, 4/-, post free, guaranteed satisfaction; trade invited, estimates free; prompt service.—Loud-Speaker Repair Works, 5, Balham Grove, London. Battersea 1321. 10394

SITUATIONS VACANT

AIR MINISTRY.
CIVILIAN Wireless Instructors Required.
VACANCIES Exist for Civilian Wireless Instructors at the Electrical and Wireless School, Royal Air Force. The commencing rate of pay is £4 a week inclusive, which may be increased to £4 5s. a week after a short period of satisfactory service. Candidates must be capable of lecturing and must have a sound knowledge of electrical principles and their application to Radio and low-power electrical engineering. Applications should be addressed to the Under Secretary of State, Air Ministry, Savoy Hill House (S.5.d.), London, W.C.2, giving full particulars as to previous experience, age, etc. Candidates will be required to appear before a Selection Board at the School, for interview and test. The test will include the giving of a lecture on any subject which may be chosen by the candidates, involving the principles of modern radio. Lecturing sequence and style are most important. 10571
RADIO Valve Engineers Required Immediately, for development of transmitting valves, previous experience and a University degree of equivalent preferred.—Reply, giving age and full particulars, to Cosmos Mfg. Co., Ltd., Brimsdown, Enfield. 18891
EXAMINERS and Testers Required in Factory Producing Radio Receivers and Transmitters for the Services; permanent and interesting work for good men; Croydon district.—Write, stating age, salary and experience, Box 952, c/o The Wireless World. 18882
VACANCIES Exist for Civilian Wireless Instructors at the Electrical and Wireless School, Royal Air Force. The commencing rate of pay is £4 a week inclusive, which may be increased to £4 5s. a week after a short period of satisfactory service. Candidates must be capable of lecturing and must have a sound knowledge of electrical principles and their application to Radio and low-power electrical engineering. Applications should be addressed to the Under Secretary of State, Air Ministry, Savoy Hill House (S.5.d.), London, W.C.2, giving full particulars as to previous experience, age, etc. Candidates will be required to appear before a Selection Board at the School, for interview and test. The test will include the giving of a lecture on any subject which may be chosen by the candidates, involving the principles of modern radio. Lecturing sequence and style are most important. 10616

Notes

on the War-time Programme of Belling & Lee Ltd.

DEALERS

Business is almost normal. While some dealers and wholesalers have stopped ordering, we feel that these conditions will prove temporary, as many other dealers are already taking advantage of the excellent battery set demand and selling more aerials than usual. This is due to the fact that a battery set, lacking the "punch" of a mains operated set, demands a better aerial. Increased battery set sales have also caused a rush for wander plugs, aerial and earth plugs, etc.

One thing is very certain, the present broadcast wavelengths are bringing in an unusual amount of mains interference, thus creating a demand for the Type 300 Mains Filter which can be used to reduce this interference to insignificance.

Our Service Department is still functioning, but with a rather depleted staff, as some members have volunteered for National Service. Also, there are times when those remaining are fully engaged in work of an official nature which in these times must receive priority over all other matters.

The new "Skyrod" Aerial shown at Olympia has been delayed somewhat, owing to a temporary hold-up for certain essential raw materials. Therefore, for the present, pre-Olympia styles are being sold.

MANUFACTURERS

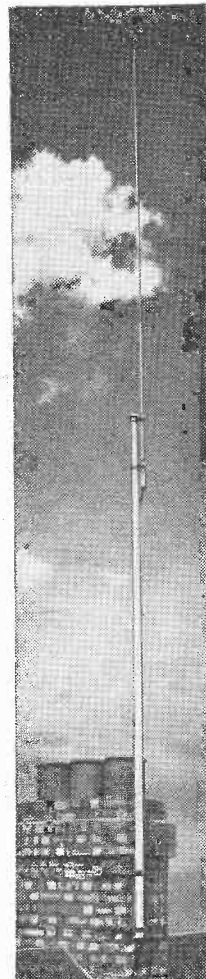

We are fully organised for a twenty-four hour work-day and highly experienced in the conditions

of work from the Air Ministry, Admiralty and Post Office Departments. We also maintain our own approved inspection organisation.

For some time now it has been our practice to carry reasonable stocks of the essential raw materials for the class of work for which we are best equipped, namely Aircraft Components, and in particular, Connections for Aircraft Wireless Gear, Fuses and Fuse-holders, Terminals of both Air Ministry and War Office patterns, etc., and probably there is no other firm in the country in a position to improve on our deliveries.

NEW PUBLICATIONS

Belling-Lee General Catalogue, 52 pages, 96 illustrations and 94 blue prints. Fully descriptive. Post free **1/6**
Copy sent free to manufacturers applying on letter-heading.
"Suppression of Electrical Interference." A new Belling-Lee Publication (not a catalogue).
Stiff cloth covers, 90 pages, 70 illustrations. Post free. **3/9**

BELLING & LEE LTD
CAMBRIDGE ARTERIAL ROAD, ENFIELD, MIDD.X

CA 8352

MISCELLANEOUS

EVERY Radio Dealer Who is Not a Regular Reader of "The Wireless and Electrical Trader" should send his trade card at once for a specimen copy and full details of the "Trader" Services. "The Wireless and Electrical Trader" has the widest influence, the largest weekly circulation, and is read by all the leading manufacturers and traders. Trade only. 15/- per annum, post free.—Published at Dorset House, Stamford St., London, S.E.1. [0615]

"ENGINEER'S Guide to Success" Shows How to Quality in Television Radio Engineering and Servicing, sound, recording, wireless communicating, etc., by studying at home with the T.I.G.B. Write to-day for this Great Guide—free—which gives full particulars, contains the world's widest choice of engineering courses—over 200—and also gives the regulations for qualifications such as A.M.I.E.E., A.M.I.R.E., A.M.I.T.E., A.M.I.W.T., C. and G., etc. Training until successful guaranteed.—The Technological Institute of Great Britain, 82, Temple Bar House, London, E.C.4. (Founded 1917. 20,000 successes.) [8872]

PATENTS

"PRACTICAL Hints on Patents," free on application. The Imperial Patent Service, First Avenue House, High Holborn, W.C.1. Preliminary consultation free. [0481]

TUITION

RADIO Training.—P.M.G. exams. and I.E.E. Diploma; prospectus free.—Technical College, Hull. [0611]

PRACTICAL Postal Courses, radio television; test equipment design; I.P.R.E. and I.W.T. exams.—Write I.P.E. 3, Shirley Rd., London, W.4. [8838]

BUSINESSES AND PROPERTY FOR SALE, TO BE LET, OR WANTED

"THE Wireless and Electrical Trader" is an essential part of the equipment of every Wireless Trader; its pages reflect the very latest turn of trade events, and it is read by all the leading dealers and manufacturers, for particulars of businesses offered or wanted. By subscription to the trade only, 15/- per annum, post free.—Send your trade card for specimen copy to Dorset House, Stamford St., London, S.E.1. [0614]

BOOKS, INSTRUCTION, ETC.

NUMEROUS "Wireless Worlds" for Sale; 3d. each, plus postage.—Armstrong, Gresham House, Corbridge, Northumberland. [8890]

AMERICAN Valve Data.—The 200-page Raytheon Data Book gives full characteristics, applications, all types American valves; invaluable to servicemen; post free anywhere; 2/5.—Leonard Heys, 36, Henry St., Blackpool. [0594]

BOOKS, INSTRUCTION, ETC.

"RADIO Data Charts." By R. T. Beatty, M.A., B.E., D.Sc. Second edition. A series of Abacs providing most of the essential data required in receiver design and enabling problems to be solved without having recourse to complicated mathematical formulae. Price 4/6 net. By post 4/10, from Iliffe and Sons Ltd., Dorset House, Stamford Street, London, S.E.1.

"ELEMENTARY Principles of Wireless Telegraphy and Telephony." By R. D. Banguay. Revised by O. F. Brown, B.Sc. Third edition (1930). The standard textbook for wireless students and beginners. Deals with the whole subject of wireless telegraphy and telephony, avoiding too technical a treatment of the problems involved. Well illustrated. Price 7/6 net. By post 8/-, from Iliffe and Sons Ltd., Dorset House, Stamford St., London, S.E.1.

"THE Wireless World" Diary for 1939 contains 77 pages of facts, formulae and general information of the kind that is always wanted but is difficult to follow. Also a list of the most important European Broadcasting Stations and short-wave stations of the world. Twelve pages of circuit diagrams of receivers, amplifiers and units.—By post 1/7 from Iliffe and Sons Ltd., Dorset House Stamford Street, London, S.E.1.

"FOUNDATIONS of Wireless." By A. L. M. Sowerby, M.Sc. Second edition. An elementary textbook on receivers. Deals fully with the construction of wireless sets, valves, and the process of detection. Price 4/6 net. By post 4/11, from Iliffe and Sons Ltd., Dorset House, Stamford Street, London, S.E.1.

Fourth Edition of

WIRELESS SERVICING MANUAL

By W. T. COCKING (of "The Wireless World")

—Revised and enlarged with 50 additional pages

Cloth Boards
Size 7½ ins. x 5 ins.
288 Pages.

5/- net

By post 5/5.

The most complete book of reference of its kind. A reliable practical guide for amateur and professional.

The "Wireless Servicing Manual" deals fully with Testing Apparatus, and explains the methods of locating and curing faults in receiving equipment, and includes an additional chapter on television receivers.

Ganging, Automatic Volume Control, Instability, Distortion, Mains Hum, Whistles and Local Interference are all separately treated. There is also a special chapter on the Aerial-Earth System.

Information on short-wave receivers, and on methods of operating extension loud speakers, is also given.

Issued in conjunction with "THE WIRELESS WORLD" and Published by the Proprietors—

ILIFFE & SONS, LTD., DORSET HOUSE, STAMFORD STREET, LONDON, S.E.1

W.W.20

KEEP POULTRY

and help to increase the food supply

● Last week: Town dwellers who keep fowls can use their food scraps to increase the nation's egg supply. There are no problems about small poultry keeper

● This week: Management of Small Laying Flocks

HOUSING STOCK and FEEDING

which are not solved for you in the Special Beginner's Section of

NOW ON

SALE

2^D

ORDER YOUR COPY AT ONCE

Send a postcard for a free specimen copy to

POULTRY WORLD LTD., Dorset House, Stamford Street, London, S.E.1

Second Edition—

RADIO DATA CHARTS

A SERIES OF ABACS

providing most of the essential Data required in Receiver Design.

By R. T. BEATTY, M.A., B.E., D.Sc.

Published from the Offices of
"THE WIRELESS WORLD"

"Radio Data Charts" provide designers of wireless apparatus with a ready and convenient means of solving problems without having recourse to complicated formulæ and mathematics.

By the use of "Radio Data Charts" such abstruse problems as the design of tuning coils are solved almost as easily as the simple application of Ohm's Law.

Price 4/6 net

By post 4/10

From leading booksellers or direct from the publishers

ILIFFE & SONS LTD.

Dorset House, Stamford Street, London, S.E.1

W.W.93

Memo

Don't forget

Player's

Please

PLAYER'S NAVY CUT CIGARETTES

MEDIUM or MILD
10 for 6²/₂ 20 for 10²/₂

NCC495B

B.I.

COPPER EARTHING RODS

for WIRELESS APPARATUS

(U.K. Patent Nos. 433593, 423385, 430040.)

100% MORE SURFACE AREA

Designed to give a low resistance earth contact. Made from solid drawn H.C. copper. The multiple fins ensure larger surface area and better contact with the earth than any driving earth of similar diameter and weight at present on the market; giving nearly 50 per cent. more contact area than a circular rod of equal diameter, or 100 per cent. more than a solid rod of equal weight.

About 1 1/2" of the rod is left exposed and the earth lead is simply clamped against the rod by means of the copper clamping ring and screw. No sweating or soldering is required. Supplied in two standard sizes, 18" and 24". Longer rods of similar type can be supplied, if desired, to meet special requirements.

BRITISH INSULATED CABLES LTD.,
CABLE MAKERS AND ELECTRICAL ENGINEERS,
PRESCOT, LANCS. Tel. No. PRESCOT 6571

CUT HERE

EMERGENCY ORDER FORM

● Order your WIRELESS WORLD in advance.

Please place a regular order for the WIRELESS WORLD with your newsagent if you wish to be certain of securing a copy each week. In future it is unlikely that newsagents will have copies available unless they are definitely ordered in advance.

Please reserve/deliver The WIRELESS WORLD every week until further notice.

NAME..... Date.....

ADDRESS.....

SUBSCRIPTION RATES
If you wish to receive your copy direct by post the following subscription rates apply:—

For One year	£1.10.4
" Six months	15.2
" Three months	7.7

Enclose remittance with order.

ILIFFE & SONS LTD.,
Dorset House, Stamford Street,
London, S.E.1. Phone: WATerloo 3333

● The WIRELESS WORLD will continue to supply you with essential technical information and wireless news and in national work the WIRELESS WORLD will be of the greatest importance to you.

SIGN & HAND TO YOUR NEWSAGENT TO-DAY

Mention of "The Wireless World," when writing to advertisers, will ensure prompt attention.

—Third Edition of

WIRELESS DIRECTION FINDING

BY R. KEEN, B.Eng.

A BOOK OF INSTRUCTION AND REFERENCE FOR ENGINEERS, TECHNICIANS, TELEGRAPHISTS AND OTHERS ENGAGED OR INTERESTED IN THE USE OF DIRECTIVE WIRELESS TELEGRAPHY FOR THE NAVIGATION OF SHIPS AND AIRCRAFT

The third edition of this well-known book deals with the principles of Wireless Direction Finding and gives an account of the circuits and apparatus used in its application to navigation. The Adcock Aerial has a separate chapter covering its principles together with much information on its installation and performance. Further chapters are included on Shore, Ship and Aircraft installations as well as a special section on the choice of a suitable site for the Aircraft Ground D.F., with Adcock Aerials.

Engineering students and research engineers will find useful references to a selected list of some 600 of the more important contributions to the literature of D.F.

800 pages 550 illustrations

PRICE 25/- net By post 25/9

From leading Booksellers or direct from the Publishers:

LILIFFE & SONS LTD., DORSET HOUSE, STAMFORD STREET, LONDON, S.E.1

Sixth EditionRevised and Enlarged**HANDBOOK of
TECHNICAL INSTRUCTION for
WIRELESS TELEGRAPHISTS**

by H. M. DOWSETT

(M.I.E.E., F.Inst.P., M.Inst.R.E.)

This standard handbook is planned primarily for the use of wireless operators, whether prospective or actual. It is virtually a complete theoretical course for students wishing to qualify for the Postmaster-General's Certificate of Proficiency.

CONTENTS INCLUDE:

The Electric Charge and the Condenser—The Condenser in Practice—Direct Current and Ohm's Law—Scalar and Vector Quantities and Curve Plotting—Primary Batteries—Accumulators—Magnetism—Electro Magnetism—Self-Induction—Dynamo Electric Machines—Measuring Instruments—Switchboards and Switchgear—Alternating Current Effects, and Vector Diagrams—Alternating Current Fundamental Formulae—Alternating Current Generators, Alternating Current Motors and Transformers—Damped Oscillations—Commercial Types of Spark Transmitter—Aerials and Radiation—Simple Receiver Circuit and Crystal Detector—Thermionics and the Various Applications of the Valve—Depth Sounding—Valve Transmitters—Wavemeter and Transmitter Adjustment—Theory of Valve Receiver Circuits—Valve Receivers—Short Wave Aerials and Apparatus—Marine Direction Finders—Marine Audio Relay Service—Distress Call Apparatus—Lifeboat and Emergency Outfits—Trawler Apparatus—Maintenance of Marine Radio Installations and Possible Faults.

PRICE 21/- By post 21/9
By Foreign Post 22/-*Obtainable from leading booksellers or direct from the Publishers:*

LILIFFE & SONS LTD., DORSET HOUSE, STAMFORD STREET, LONDON, S.E.1

The **Wireless World** ^{6^D}

THE PRACTICAL RADIO & TELEVISION JOURNAL

Thursday, September 28th, 1939



FOURTH EDITION

*Revised and Enlarged with 50 Additional Pages***WIRELESS SERVICING MANUAL**By **W. T. COCKING***(of "The Wireless World")***The most complete book of reference of its kind. A reliable practical guide for amateur and professional**

The present Edition of the "Wireless Servicing Manual" brings the material of the book right up to date and includes an additional chapter on television receivers which is practically the only source of servicing information available on this subject.

Testing apparatus is fully dealt with and the methods of locating and curing faults in receiving equipment are explained.

Ganging, Automatic Volume Control, Instability, Distortion, Mains Hum, Whistles, Local Interference and Aerials, are all separately treated.

The reference material, including base-connections for British, Continental and American Valves, and the various colour codes for components, has been extended and revised.

BOUND IN CLOTH BOARDSSIZE $7\frac{1}{2}$ ins. x 5 ins.

288 Pages

5/- net. By post 5/5

Issued in conjunction with "THE WIRELESS WORLD" and Published by the Proprietors:—

ILIFFE & SONS LTD., DORSET HOUSE, STAMFORD STREET, LONDON, S.E.1

W.W.27

—Third Edition of

WIRELESS DIRECTION FINDINGBY **R. KEEN, B.Eng.****A BOOK OF INSTRUCTION AND REFERENCE FOR ENGINEERS, TECHNICIANS, TELEGRAPHISTS, AND OTHERS ENGAGED OR INTERESTED IN THE USE OF DIRECTIVE WIRELESS TELEGRAPHY FOR THE NAVIGATION OF SHIPS AND AIRCRAFT**

The third edition of this well-known book deals with the principles of Wireless Direction Finding and gives an account of the circuits and apparatus used in its application to navigation. The Adcock Aerial has a separate chapter covering its principles together with much information on its installation and performance. Further chapters are included on Shore, Ship and Aircraft installations as well as a special section on the choice of a suitable site for the Aircraft Ground D.F. with Adcock Aerials.

Engineering students and research engineers will find useful references to a selected list of some 600 of the more important contributions to the literature of D.F.

800 pages

550 illustrations

PRICE 25/- net By post 25/9*From leading Booksellers or direct from the Publishers.***ILIFFE & SONS LTD., DORSET HOUSE, STAMFORD STREET, LONDON, S.E.1***Mention of "The Wireless World," when writing to advertisers, will ensure prompt attention.*

The Wireless World

THE
PRACTICAL RADIO
JOURNAL
29th Year of Publication

No. 1048

THURSDAY, SEPTEMBER 28TH, 1939

VOL. XLV No. 13

Proprietors : ILIFFE & SONS LTD.

Editor :
HUGH S. POCKOCK.

Editorial,
Advertising and Publishing Offices :
DORSET HOUSE, STAMFORD STREET,
LONDON, S.E.1.

Telephone : Waterloo 3333 (50 lines).
Telegrams : "Ethaworld, Sedist, London."

COVENTRY : 8-10, Corporation Street.
Telegrams : "Autocar, Coventry." Telephone : 5210 Coventry.

BIRMINGHAM :

Guildhall Buildings, Navigation Street, 2.
Telegrams : "Autopress, Birmingham." Telephone : 2971 Midland (5 lines).

MANCHESTER : 260, Deansgate, 3.
Telegrams : "Iliffe, Manchester." Telephone : Blackfriars 4412 (4 lines).

GLASGOW : 26B, Renfield Street, C.2.
Telegrams : "Iliffe, Glasgow." Telephone : Central 4857.

ENTERED AS SECOND CLASS MATTER AT
NEW YORK, N.Y.

As many of the circuits and apparatus described in these pages are covered by patents, readers are advised, before making use of them, to satisfy themselves that they would not be infringing patents.

CONTENTS

	Page
Editorial Comment	287
Deaf-aid Adaptor. By R. H. Wallace	288
Unbiased. By Free Grid	292
Switching on the News	293
Anti-harmonic Filters. By A. G. Chambers and W. Bacon, B.Sc. (Eng.)	295
Polystyrene	297
News of the Week	298
Characteristic Impedance and All That. By "Cathode-Ray"	299
Whaling and Wireless	301
Accumulator Charging in the Wilds. By W. H. Cazaly	303
Random Radiations	304
Recent Inventions.. ..	306

EDITORIAL COMMENT

We Carry On

New Publishing Arrangements

DURING the last war, *The Wireless World* continued publication without interruption, and to us it is inconceivable that we should do otherwise during the present struggle, in which radio has assumed vastly greater importance.

But experience of wartime conditions has convinced us at an early stage that some change is necessary if we are to continue to render to our readers the service that provides the justification for our continued existence. Our technical staff has already been depleted by calls from the various wireless branches of the Defence Services, and many of our contributors can devote less time than formerly to work for this journal. To continue as a weekly publication would, it is feared, introduce some risk of a falling-off in the standard we have set ourselves.

It has therefore been decided that *The Wireless World* shall in future appear in monthly and enlarged form at the price of one shilling. As there is bound to be some slowing-up of technical progress, we anticipate that the new arrangement will enable us to present an adequate record of developments without too great a time-lag.

Next Issue October 20th

For the duration of the war, this will accordingly be the last weekly issue of *The Wireless World*, but, to avoid a too sudden transition to the new periodicity of publication, arrangements have been made for the first enlarged shilling number to appear on Friday, October 20th, and the journal will thereafter appear on the 20th day of each month.

Advantage will be taken of the changeover to make such alterations

in the *format* of the journal as are appropriate to the new method of publication, though the scope and technical standard will be unaffected. There will be many more pages, but the page size will be smaller, and the journal will be more compact and convenient.

The relationship between this journal and its readers has always been so friendly that we do not hesitate to ask of them one small favour. This is that a definite order, a form for which will be found inserted in this issue, should be given to newsagents to reserve a copy of each issue, beginning with that of October 20th. Readers in the Services or overseas may find it more convenient to subscribe direct to our publishing office; the new rates are 14/- per annum for home or abroad.

Press and Broadcasting

Unnecessary Antagonism

A RECENT statement by the Minister of Information suggested that the Press of this country was seriously perturbed by competition from the B.B.C. in the dissemination of news.

In the days when wireless was struggling tooth and nail to establish itself, we might have found in this admission some cause for jubilation, but now that broadcasting has "arrived" we merely view the matter with mild disquiet. We, though wireless people, would hate to see a state of affairs where broadcasting became the sole, or even the main, channel of news distribution. There is really no need for antagonism, as both parties will find out when they have had time to evolve the right techniques for changed conditions. The trouble at present is that broadcasting is too much like the newspapers, and the newspapers are too much like broadcasting.

Deaf-aid Adaptor

FOR USE WITH A STANDARD BROADCAST SET

By R. H. WALLACE

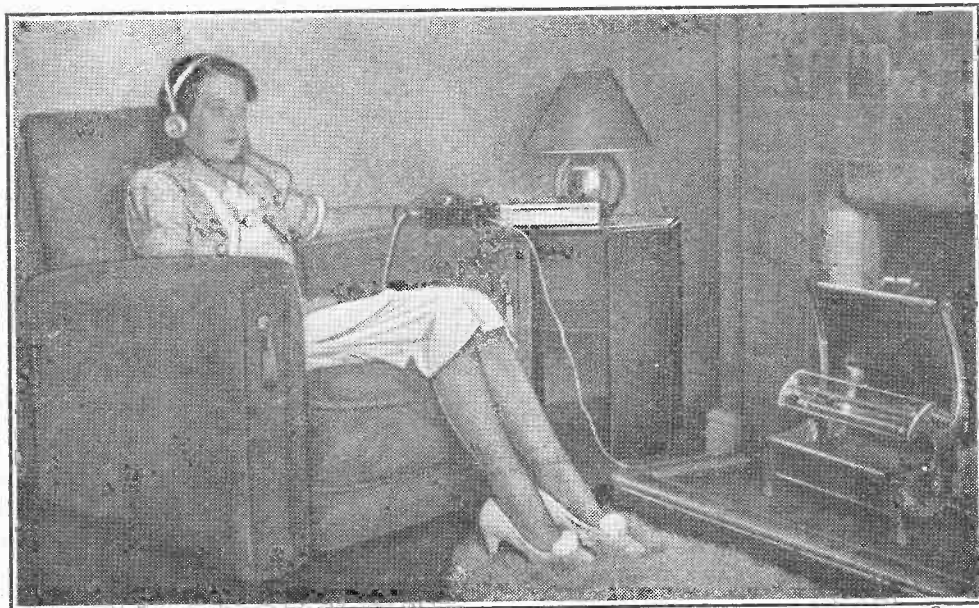

Finished unit in use from a loud-speaker extension point.

the volume control to give an output comparable with that of the set. As it can be used from an extension point in another room, it is very suitable for use by an invalid. The assembly is small enough to be readily used on the arm of a chair, and this gives considerably greater freedom to the wearer than if the phones were plugged direct into the set.

Strictly speaking, every deaf person requires a unit expressly designed and corrected for his peculiar aural characteristics; this also applies to every individual of normal hearing. In practice, however, it is not necessary to worry unduly about precise adjustment, but considerable divergences do require correction. It will very often be found that deafness is associated with a progressive diminution in response to frequencies at one extreme or the other, while less commonly these two may be combined, resulting in a pronounced distortion. Therefore if the unit can be arranged to provide some tilting of the response towards either the treble or the bass, then the required conditions will be obtained; this in addition, of course, to the general rise in volume. The latter may be readily attained, in the case in question, by an increase in the ratio of step-up from a low resistance extension,

As suggested in an earlier article, the use of headphones in conjunction with the set gives an opportunity of raising the volume level to a very considerable extent without making it objectionable to other listeners in the room. Those merely hard of hearing do not generally find much difficulty in reception, as the majority of sets are worked at a volume appreciably above the level of the original, at least for all the quieter portions of the programme time. However, those very hard of hearing, and the deaf, need a step-up in volume far greater than can be provided by the simple use of the set control; that is, unless they sit very close to the loud speaker, which generally involves a cramped and uncomfortable position. In addition, in many cases,

In last week's issue we described the use of headphones—principally as a wartime measure—in conjunction with standard loud-speaker sets. The design of a deaf-aid, also intended for headphone listening and adaptable to similar sets, is now discussed.

some measure of additional tone control is necessary in order that the deaf may enjoy the programmes to the full, and this can be provided with the unit about to be described. These desirable features can be obtained without much expense, and entirely without the use of extra batteries or valves, since the whole output of the ordinary set is not needed even for the very deaf.

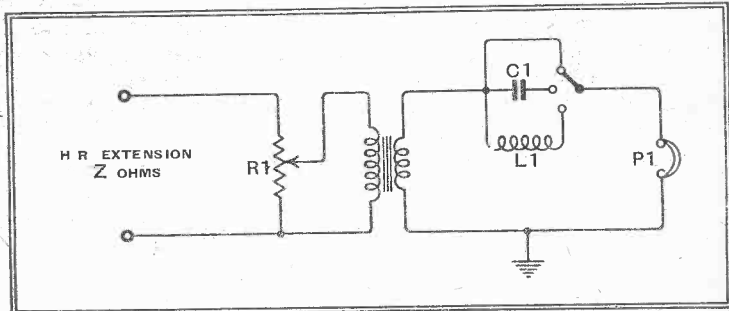

Fig. 2.—Circuit preferred to that of Fig. 1 when HR extension is provided. Volume increase up to 20 to 30 decibels. R1, 2 × Z ohms, 3 watts; C1, 0.1 to 0.01 mfd.; L1, 0.3 to 3 henrys; Z, extension impedance in ohms; P1, 1,000-ohm phones; transformer step-down

$$\text{ratio } \sqrt{\frac{Z}{2,500}}$$

or a corresponding decrease in the step-down from a high impedance output. Since considerable power will have to be handled by a transformer in this case, the selection should be made with care, having regard both to adequate insulation between windings, physical size, and the ability to deal with up to 3 watts of audio energy on peaks.

In the case of a high-impedance extension where isolating condensers are used followed by a potentiometer, as suggested in the previous article, the value of this component need not be changed, and the simple omission of the limiting series re-

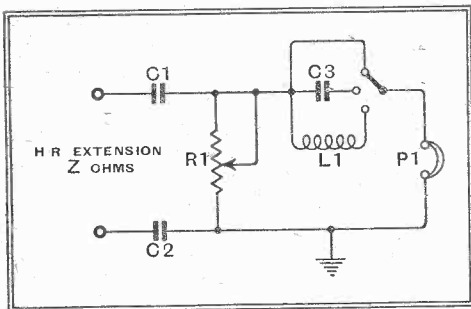

Fig. 1.—Circuit giving bass or treble lift or straight-line boost of volume for deaf-aid from high-impedance extension sockets. Use the higher values of inductance and lower capacities for HR phones. Z, extension impedance in ohms; C1, 1 mfd. 500 volts working; C2, 1 mfd. 500 volts working; C3, 0.005 to 0.1 mfd.; R1, 2 × Z ohms, 3 watt; L1, 0.3 to 10 henrys; P1, 1,000 ohms phones for Z of 2,000 to 4,000 ohms; 4,000 ohms for Z of 8,000 to 20,000 ohms.

Compact and Easily Built

The unit of which the design and construction are now to be described can be easily made up from standard components. It is compact, and gives a controlled increase of the volume level from the normal extension speaker terminals of the set. It is so arranged that the normal listener has only to turn down

Deaf-aid Adaptor—

istance shown there is all that is needed to give the required rise in volume; this amended condition is shown in Fig. 1, while the values for the transformer-fed

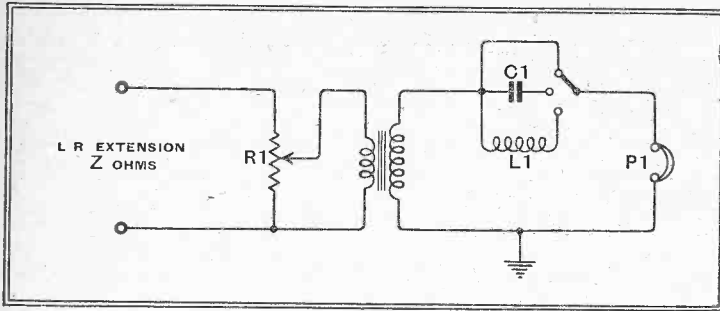

Fig. 3.—Basis of present design providing volume control and tone correction from low-impedance extension sockets. Z, extension impedance in ohms; R1, $2 \times Z$ ohms, 3 watts; C1, 0.1 to 0.01 mfd.; L1, 0.3 to 3 henrys; P1, 1,000-ohm phones; transformer step-up ratio $\sqrt{\frac{2500}{Z}}$

arrangements are given in Figs. 2 and 3. It will be noted that in these cases it is assumed that the earpieces will be paralleled to give a net resistance of 1,000 ohms in order to avoid the use of higher inductance chokes with consequent increase in size.

As explained in the previous article, it is preferable to use simple rejection circuits for the tone control, and, while it is easy to multiply the number of response curves available, the writer suggests that these need not exceed four; in the first place a treble control in the set is an almost universal feature, and this gives a bass lift of considerable amount, while the ordinary set is not likely to suffer from any preponderance of top notes. Further two degrees of treble lift will satisfy most requirements, and if it is possible to provide for one position in which both extremes are lifted, the switching requirements will be quite stringent enough for a compact assembly without further subdivision.

There is an especial need for some control of volume to be incorporated in the design of a unit of this type, since it will often be used by older people, who naturally will not wish to leave a comfortable chair and take off the phones in order to make adjustments. An additional requirement for such listeners is that the device must be simple without too many controls, and it should be light enough to be readily carried about.

Features of the Unit

The main specification to be realised is now fairly clear. It must provide a rise, above the normal volume of the set, of the order of twenty or thirty decibels, with, say, one degree of bass lift and two positions of treble lift, also providing for control of volume and for easy attachment to set and phones. It is desirable also that the tone controls should make as little difference as possible to the loudness level when operated, though since the volume control will be close at hand, this is not

absolutely essential. It is naturally preferable to use standard parts, which are readily obtainable, and the size should hardly exceed 7in. \times 4in. \times 2½in.—the smaller the better.

Technical considerations indicate that the potentiometer must handle short peaks up to 3 watts, and a value of 10 ohms will be suitable for most low-resistance extensions. The transformer may have to deal with as much as 3 watts when the volume is set at maximum, and the switch must have at least five positions on each of two poles.

special components listed are necessary, or that transformers and switches which may be on hand, and which agree with the circuitual requirements, are of no use. There is no reason, save that of space, why older components should not be used; however, those listed have been chosen so that a very compact assembly results, and this will hardly be possible with parts taken at random.

Small-size Components

There is not a large choice of volume controls of the required low value of 10 ohms now available. The one recommended is as small as any; there are several transformers of suitable value among the output types of various makers; the one used was chosen because the

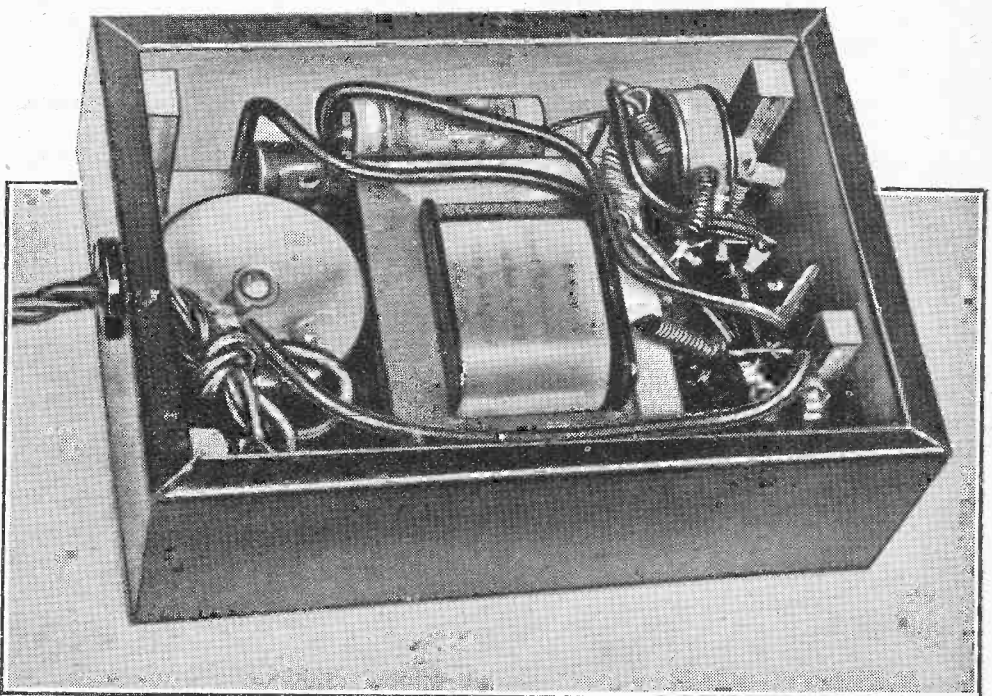

Finished unit, wired and assembled. The position of most of the components is clearly shown.

The final circuit diagram adopted is given in Fig. 4.

Now it must not be thought that the

absence of terminals permitted a shallow container to be used. The specified switch is the smallest one covering the required circuit changes, which is available to the general public, as far as the writer is aware. One of the most difficult components to choose was the choke; calculations and experiment showed that this should have a value between 0.5 and 1 henry; now this value is available in air-cored form, but then takes considerable space, while the usual tone-control choke of the same value is in most

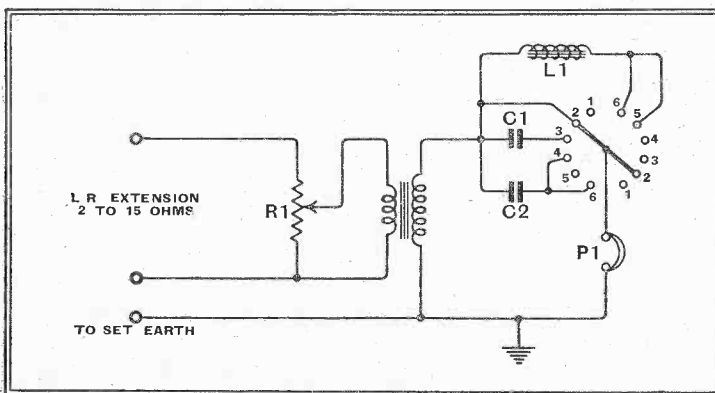

Fig. 4.—Circuit of unit as finally developed, using the specified components and phones with the earpieces paralleled to reduce the resistance and make the tone control more effective. R1, 10 ohms, variable, 3 watt; C1, 0.1 mfd.; C2, 0.02 mfd.; L1, 0.7 henry; P1, 1,000-ohm phones; transformer ratios 1 to 25 and 1 to 35, to handle 3 watts. Switch settings: 1, off; 2, normal step-up; 3, top lift 1; 4, top lift 2; 5, bass lift; 6, top and bass lift.

Deaf-aid Adaptor—

cases a still bulkier component, since the demand is small and there are few types to choose from. It would, of course, have been possible to use two superhet RF chokes in series, but the smallest of these would still be rather bulky. Finally a solution was found in the use of an ultra-small microphone transformer, the primary of which has the convenient value of 0.7 henry; it must be noted that this is possible owing to the fact that there is no DC component passing through, otherwise the use of an ungapped core would not give the required inductance. The selection was completed by the inclusion of a midget insulated jack, and it was found possible to assemble the potentiometer, switch, transformer, choke, jack and two wire-end condensers in the total space of $3\text{ in.} \times 4\frac{3}{4}\text{ in.} \times 1\frac{1}{4}\text{ in.}$

It will be noticed that the last position of the switch puts the 0.02 - mfd. condenser in parallel with the choke, the combination being in series with the phones; these constitute a circuit very flatly tuned to about 1,000 cycles per second which tends to reduce the response over the middle frequencies, leaving the extremes unaffected. It will not often happen that this position is required, but there are cases where it is advisable. As there was a spare point on the switch this was made use of to switch off the phones, though this is hardly necessary, as it is almost as easy to withdraw the plug from the jack; in either of these cases the load on the output stage is maintained, and it is not necessary to switch the set off for short intervals.

The construction of the unit is not difficult, but does call for some patience in the wiring, owing to the small amount of space available.

Unless a small soldering iron happens to be handy it will probably be worth while to make one with a bit not more than an inch long. The contacts of all the components should be tinned with a larger iron before assembling them in the case.

The box in which the unit is housed is preferably of wood, since this makes the construction simpler owing to the confined space, and the fact that the wires and components are in direct contact with the sides; the use of insulating bushes is also thereby avoided. It is necessary, in making up this case, to work very closely to the prescribed internal dimensions, and as long as these are adhered to the actual

thickness does not much matter; however, an armchair unit is liable to be dropped occasionally, and should be robust, so $\frac{1}{4}$ in. thick plywood is recommended. It is largely a matter of personal taste whether the outside is finished by polishing or covered with leatherette; the latter is favoured by the writer, since it will then cause no damage to any polished furniture on which it may be placed. If this method of covering is adopted it will be found that a lot of difficulty is avoided by drilling all the holes through the box before applying the leatherette, which may then be secured with wood glue or seccotine, and when dry the holes can be cut through with a sharp knife. It is very difficult to make neat holes when the covering is already on.

Mounting the Transformer

The larger transformer will not fit in until the lugs have been bent down at right angles to the base; it is then secured, at one end only, by a screw through the lug to the side of the case, sandwiched between the switch and volume control, which hold it endwise and prevent it from vertical movements by the top and bottom

bush of suitable size for the flex lead-in this should be fitted now. The spindles of the two controls are longer than necessary for the present purpose, and must be shortened so that the knobs just clear the case. When all the components have been provisionally fitted, the four corner pieces to which the lid is secured should be cut to the right length, which is such that a flush fitting is secured, and then glued in place; one of these is not right in the corner as this is occupied by the jack; the cover is held to these by four well-counter-sunk screws.

Should it be found that the bobbin of the transformer now prevents the lid from fitting properly, a small amount of wood should be pared away, while any small space remaining between the two should be filled in with a slip of wood or card, the object being to secure this rather heavy component independently of its fixing lugs.

The wiring of the unit may now be commenced. It will be found that the lower ratio of the LF62 transformer is normally sufficient, and the tapping marked with a blue spot should be tucked away underneath after the end has been covered by a piece of sleeving; the two leads which comprise this tapping should be soldered together first. The low resistance primary of the LF64 transformer is the only winding used, and it should be noted that this was connected between the green and red leads in the specimen obtained by the writer; in any case, it is easy to check this point, since the other winding has a resistance of the order of 2,000 ohms, and a flash lamp and battery will soon disclose which is the right one to use.

The triple flex lead from the set is knotted about two inches from the end and then bared and tinned; one wire goes to each end of the volume control, and the third (earth) wire to the tag on the case of the latter, this being the most convenient point of anchorage. The two remaining heavy wires from the main transformer, marked with green and red spots, are taken underneath this and soldered, one to the slider of the potentiometer and the other to the low-potential end of the element. Next it is wise to bare the ends of the leads from the choke (primary of LF64) and solder one to contacts 5 and 6 of the switch—remember this is upside down. Then the grey wire from the large transformer is joined to the earthed tag on the case of the

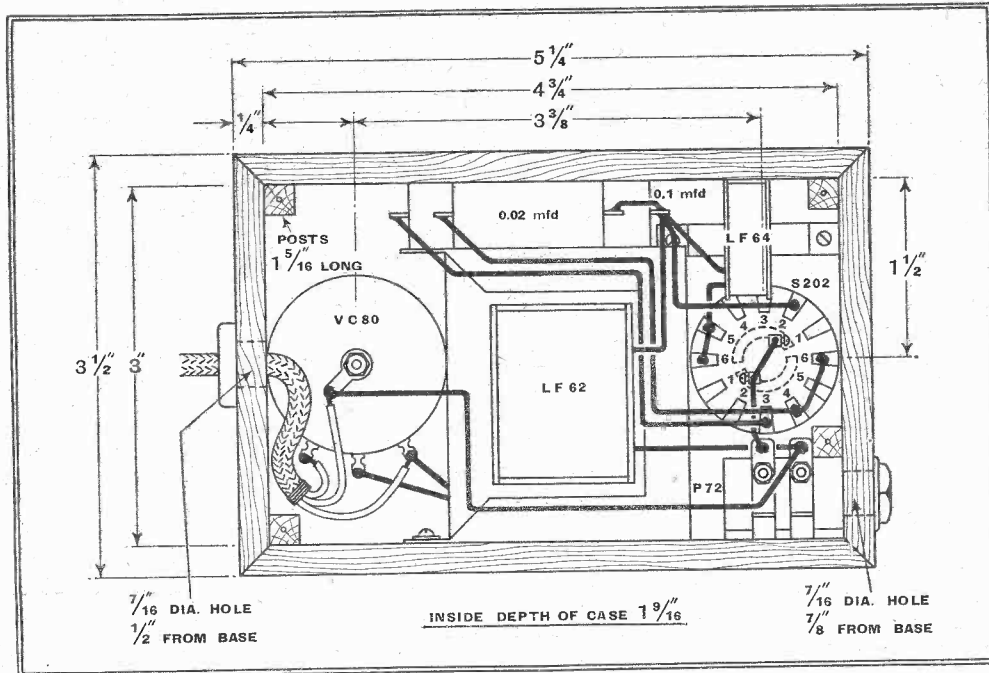

Fig. 5.—Wiring diagram of the deaf-aid adaptor unit. When constructing the unit work to inside dimensions.

of the box, which should fit the sides of the bobbin tightly. The dimensions given make these fits rather close, and should there be insufficient length for the transformer, either the volume control or the switch should be moved towards the end of the container slightly. It will, of course, be necessary to make a small hole in the underside of the top panel to accommodate the projection on the switch which is intended to prevent it from turning.

The jack and choke are fitted as shown in the diagram and photo, and sufficient space will be found for the two condensers between the main transformer and the side of the case. If it is possible to obtain a

Deaf-aid Adaptor—

volume control, and also to one terminal of the phone jack, that nearest to the end for preference.

The wire-end condensers are now placed in position, secured if necessary by a turn or two of tape or wedged with card. The wires from the choke end of these condensers are then turned up at right angles and soldered together, forming a common anchorage for the other wire from the choke and the thin yellow lead from the transformer. The other wire from the 0.1-mfd. condenser is lengthened and

taken to contact 3, on the other side of the switch from that to which the choke is connected, and the lead from the 0.02-mfd. condenser is similarly treated and soldered to contacts 4 and 6 on the same side as its companion. The common junction point of condensers and transformers is connected to contact 2 on the switch; the particular side does not matter since this is the normal response connection, but the side just dealt with is the nearest. The last step is the joining of the two central contacts of the switch together and to the remaining terminal of the jack, and the wiring is complete.

The finished unit should now be tested to ensure that the wiring is correct. The connections of the switch are the most confusing, since all the wiring is done with this upside down; in addition it may possibly be found that the volume control works the wrong way round; this does not really matter, but is more convenient to remember if a clockwise movement increases volume. The base is now fixed and the unit is ready for use.

Increasing Volume

The rise in volume will be found sufficient in nearly all cases, but where the user is very deaf, or the extension impedance is lower than 4 ohms and it is desired to increase the step-up still more, the higher ratio of the transformer may readily be brought into use by connecting the blue wire, in place of the red spot, to the potentiometer. It is not suggested that there is any need to mark the different settings of the tone control, as these are readily memorised, and the user will naturally turn to that which gives the best results and leave it at that. An "off" position is provided on the switch as there is one pair of spare contacts; this disconnects the phones but leaves the load still on the output valve, so that no damage to the latter can occur if the set is left on.

This design is not suitable for high-resistance extensions, and though it can be adapted to them it is not easy to give the needed ratio for the transformer since this will vary widely with the output valve employed and with the amount, if any,

of negative feed-back used. If such modification is to be made, the volume control should have the value indicated in Fig. 2, while it may be possible to find a transformer of the right ratio in the type and size specified. If this is not possible then condenser isolation will have to be adopted, no other alteration in the values

External view of unit showing connecting flex and phones in jack. Note the compactness of the unit as shown by comparison with the phones.

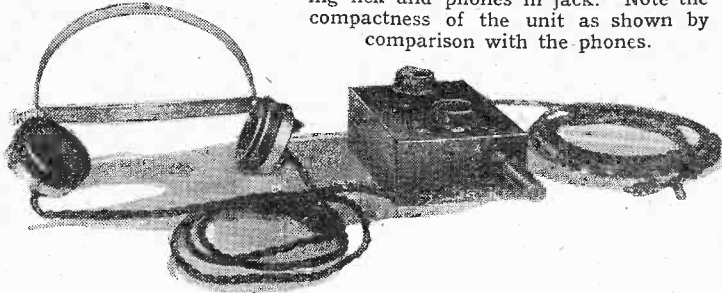

or the switching system being necessary.

The completed unit can be plugged into the extension terminals of any set having an outlet socket or extension point of between 2 and 15 ohms, and this covers most cases. The listener of normal hearing will find another advantage in the device, since it gives him an increase in volume corresponding to that obtainable from a further stage of valve amplification, and is thus handy for distant stations if the set has not much reserve. As long as the earth wire is connected to a good earth there is absolutely no danger, and the unit is completely shock-free. Almost any type of high-resistance phones will suit but, of course, the more sensitive these are the better.

The writer feels that the contrivance will meet a definite, even if comparatively small, demand, since he has often been asked if it is not possible to adapt headphones to the ordinary set; unfortunately this must often be answered in the negative, as many enquirers have not the ability to undertake the construction of such a unit as here described. These must perforce wait until some manufacturer decides to cater for their needs.

LIST OF PARTS

- 1 Output transformer, ratios 35:1 and 25:1 Bulgin LF62
- 1 Microphone transformer, ratio 1:60 (Primary as choke) Bulgin LF64
- 1 2-pole six-way rotary switch Bulgin S202
- 1 Volume control, 10 ohms, without switch Bulgin VC80
- 1 Wire-end condenser, 0.1 mfd., tubular, P.T.W., 1,500 V test Hunt's
- 1 Wire-end condenser, 0.2 mfd., tubular, P.T.W., 1,500 V test Hunt's
- 1 Midget insulated jack Igranic
- 1 Pair headphones, 1,000 ohms (or 4,000 ohms with earpieces connected in parallel) Electradix

Miscellaneous parts:—

- 2 Bakelite knobs
- 2 yards of triple flex
- 3 Countersunk woodscrews, 1/4 in. long
- 4 Countersunk woodscrews, 1/4 in. long.
- 1 Box, wood, 1/4 in. thick, inside size 3 in. X 4 1/2 in. X 1 1/2 in. with inside fitting lid at bottom
- 1 Piece of leatherette, 1ft. square
- Tinned wire, sleeving, etc.
- Ebonite bush, 1/4 in. hole, 1/8 in. outside.

Letters to the Editor

The Editor does not necessarily endorse the opinions of his correspondents

Wartime Listening

I FEEL that a word of thanks is due to the contributor of the recent article explaining the best method of adapting our sets for headphone listening to meet the particular needs of wartime. Not the least valuable part of the article is that giving details of the simple home-made unit containing transformer volume control, etc. I have been an ardent advocate of headphone listening for many months past and would venture to assert that, apart from any special wartime considerations, those who have never attempted any carefully planned headphone listening such as I indulge in, do not know what they are missing. I realise that the loud speaker is very necessary on certain occasions, and for certain types of transmission, and I would not on any account sacrifice my own high quality amplifier and

PLEASE ORDER NOW

Readers are earnestly requested to instruct their local newsagents to reserve a copy of this journal for them regularly.

This is in order to facilitate distribution arrangements and avoid the risk of failure to obtain copies.

In the interests of the paper itself in these difficult times it is particularly hoped that regular purchase be made from the same newsagent or bookstall.

Please see the emergency order form inserted in this issue.

loud speaker, but for real intimate enjoyment of talks, plays and certain types of music give me headphones every time. For the sake of comfort, headphones should be fitted with "slip-on" sponge rubber ear-caps which can be obtained quite cheaply.

J. E. HENDERSON.

Norwich.

MANY readers must have welcomed your recent headphone listening article, but there is another aspect of wartime listening on which a practical article would be welcome, and that is remote switching of the receiver. We have been told often enough how to connect up an extension loud speaker for use in another room, and most people nowadays use this undoubted reinforcement to the pleasures of listening. It has hitherto not been worth while to arrange for switching the set on or off at the distant loud speaker, since more often than not it is the desire for a change of programme which causes us to journey to the set in the next room, and remote tuning control, even using push-buttons, has been too expensive for most of us. Nowadays there is an enormous number of people whose listening, in the absence of a good SW range to their sets, is confined to the B.B.C. Home Service. The provision of remote switching of the set from the distant loud-speaker point is simple and not expensive.

R. BLYTHE.

Exeter.

UNBIASED

War and Wind

I AM very seriously perturbed over this business of electricity rationing, as it is liable to restrict my experimental activities very seriously indeed. I am, of course, a very great user of electricity both for laboratory and for domestic purposes. Since it is absolutely unthinkable that my laboratory work should suffer in any way, I have already, despite Mrs. Free Grid's protests, imposed severe restrictions on



... by the light of a guttering candle.

the use of electricity in my household for domestic purposes. I am myself setting a good example as I am writing these notes by the light of a guttering candle sitting in front of the cold ashes of a dead electric fire.

The petrol rationing is, of course, another wartime restriction which we must put up with as best we can, but it will undoubtedly do one very good thing, and that is it will give great encouragement to the development of all-electric cars and motor cycles. An all-electric bicycle was actually launched in Holland some years ago, and in this country all-electric delivery vans are, of course, already being used in large numbers by many firms in urban areas, and the only thing which has prevented their further development is the absence of charging facilities, i.e., the lack of properly equipped garages where you can call for a few minutes and change your accumulator just as you did your horses in the old coaching days. An accumulator is like a horse inasmuch that it cannot be recharged with energy in a few minutes, but if such things as voltage, ampere-hour capacity and physical dimensions were standardised it would be but the work of a moment for a "trayful" of freshly charged cells to be slipped into the place of the discharged ones.

Naturally, the unthinking ones among you will ask sarcastically where the electric energy is coming from, as all consumption from the mains is, as I have already said, to be rationed. The answer has already been provided for you by the Editor of *The Wireless World* in the

"Power from the Wind" article, published in the September 21st issue. It may be that there are some of you who may have considered the article as of only passing interest; possibly you may have even thought that it was merely a coincidence that it was published at the present juncture. I, who am in a much better position than you to read the Editor's mind, know far better, however. There is nothing to prevent each garage or charging-station erecting its own wind generator forthwith.

There is, of course, one rather obvious thing which apparently occurred neither to the author of the article nor to the Editor, and that is this. We were told in the article that the rule for wind is "the higher, the greater." It seems rather obvious, therefore, that, if a wind generator were placed on each of the barrage balloons, enough energy would be obtained to provide the whole of the industrial electrical requirements of the country, thus saving valuable coal. It is my intention to bring this matter to the attention of the Government forthwith, and as wind is closely related to hot air I have already written to my M.P. asking him to ventilate the matter in the House of Commons, and I would ask you similarly to enlist the aid of your own M.P. in this vital matter.

Somewhere in

IT is to be deplored that certain people of a thoughtless type are heading their correspondence "Somewhere in England." Not only does their carelessness give away the fact that they are in the United Kingdom and not on the Continent, but it even proclaims the particular section of the kingdom they are in. I mention this particular fact because I do not want you to glance at the illustration to this note and jump to the conclusion that I am, or have been, "Somewhere in Scotland." The land of Burns is by no means the only place in the world where they wear the kilt. It is not unknown in parts of Ireland, and right over the other side of Europe it is quite a commonplace dress, and is greatly favoured by certain Greek regiments.

It so happened that the other day duty called me to a certain place which we will designate "X," the only qualification being that it was a seaside resort. Having a few moments of leisure I wandered down to the sea front and was pleasantly surprised to find the promenade bandstand in full occupation, with a local Jack Hylton doing his best to instill some of the *joie de vivre* into the dour-looking faces of the inhabitants. I sank thankfully into a deck chair, and was soon carried away by the lilt of a waltz, the joyous cadences of which contrasted strangely with the somewhat stern and set faces of the bandmen, who looked as if they would be more at

By FREE GRID

home with the *de profundis* or something of that sort.

Now I have never claimed to possess any great musical knowledge, but I could not help observing that the efforts of the conductor were strangely out of synchrony with the music emanating from the bandmen's instruments. He seemed to be all the time lagging behind by about half a bar, and I remarked as much to the man in the next seat, who seemed, however, singularly uncommunicative. Presently, the band relapsed into a dreary dirge reminiscent of the B.B.C. in its palmiest days, and I donned the headphones of my vest-pocket portable in the hope that I might pick up some better fare from the B.B.C.'s Home Service. I was very astonished to find that the B.B.C. happened to be churning out the same tune, but my astonishment turned first to incredulity and then to wrathful realisation when the local band's further efforts also coincided with those of the B.B.C.

It was, of course, quite clear to me what was happening. The so-called band was merely a collection of local yokels suitably dressed up and endeavouring with dummy musical instruments to keep time with the B.B.C. programme which was actually being delivered by a concealed P.A. system in the roof of the bandstand. The uncommunicative person in the next seat, who turned out to be a member of the

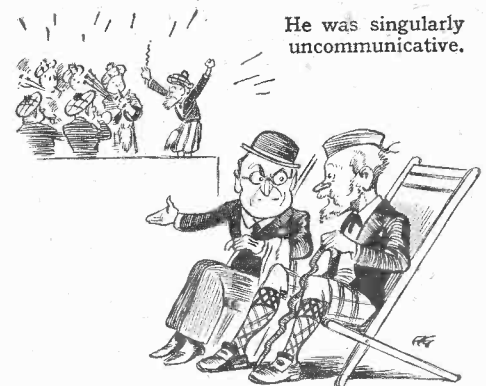

Town Council, eventually confessed the truth to me, and excused the deception on the ground that it was a wartime economy, and that as the local bandmen had all joined the colours, the Council were patriotically endeavouring to continue to give the visitors value for money. It is my firm belief, however, that the seaside resort in question, situated as it is in a notoriously parsimonious part of the country, never has possessed a band, and has for years past been saving money at the expense of its visitors, by means of this sorry subterfuge.

Switching on the News

AUTOMATIC TIME SWITCHES FOR CONTROLLING MAINS AND BATTERY SETS

DURING wartime the news bulletins and official announcements made by the B.B.C. acquire an added importance. The preoccupations and responsibilities of the listener are also increased, and we all of us sooner or later experience the annoyance of failing to hear at first hand a bulletin of more than usual interest.

The routine of switching in the set before the appointed time is one which fortunately we can delegate to a mechanical device. Time switches, although seldom seen, are in regular use in every large com-

numerals with hour and minute hands, but the time settings are made on a 24-hour basis; there is a third hand and an additional outer scale for this purpose. Contacts are provided at 20-minute intervals round the 4-hour dial and are set up or cancelled by press studs in a rotatable metal bezel ring surrounding the dial. A button on the top of the clock sets the contacts alternatively for make or break, and an indicator at the back shows a white spot when the circuit is closed. It is possible to work to closer limits than 20 minutes by setting the clock 5 or 10 minutes fast or slow. Leads with plugs and sockets are provided for the mains or LT connections, and the internal switching arrangements are capable of breaking up

hours (up to 12) are shown in a small window above the dial. It is necessary to calculate the time interval to the next news bulletin, and to set up this interval in hours and minutes on the "Chronostop" dial. When the dial returns to zero the



Model E24 "Electro-Boy" time switch clock with 30-hour spring movement.

to 600 watts DC or 1,200 watts AC at 250 volts. The price of the Model E24 with clockwork movement is £2 10s. 6d., and the Model ES24 with synchronous motor costs £2 19s. 6d.

Another interesting time switch obtainable from the above source is the "Chronostop." This is a miniature spring-driven clock movement housed in a black moulded case 2½ in. in diameter, and 1½ in. deep, with pins for plugging, fitting the standard domestic supply socket. Being spring-driven it is also suitable for con-

munity for controlling shop-window displays, street lighting, water heating, etc. They are often installed in accessible places, and have to be built to work reliably for years without attention. They can be readily adapted for controlling wireless receivers, and although their price is comparatively high they cannot be bettered where long-term reliability is the first consideration.

Some few years ago there was a good selection of less expensive programme clocks on the market. These were produced specifically for controlling wireless sets, and were obtainable with clockwork or synchronous motors—usually of foreign origin. In the more leisurely atmosphere of that period they were regarded merely as a novelty, and in the absence of a steady demand have since almost disappeared.

Clockwork Movements

Limited stocks of one or two makes are still available, and the "Electro-Boy," handled by E. Siegrist (late Orel Micro Electric, Ltd.), 39, Berners Street, London, W.1, is an example. It is obtainable with a synchronous AC movement, or a 30-hour spring clock, the latter being suitable for the control of DC or battery sets. The clock face carries the normal 12-hour

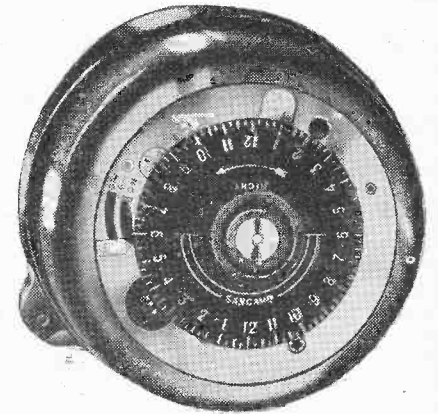

Sangamo Weston Type SSA time switch for 50 cycles AC mains

switch is tripped and the clock movement is stopped positively. A lever at the side can be set to break instead of making the circuit if desired. The price of this switch is 37s. 6d.

An inexpensive time switch incorporating a 30-hour clockwork movement is also made by Elcap, Ltd., 1, Lozells Road, Aston, Birmingham, 19. It is capable of breaking 5 amps. at 230 volts, and the list price of the Model DN for switching "on" automatically and "off" by hand is 18s. 6d.

Standard Time Switches

There are indications that more manufacturers are turning their attention to the development of time switches specially designed for wireless receivers. In the meantime time switches for lighting control, which are already a standardised product, may be regarded as the most reliable source of supply. In general, they are suitable only for controlling AC mains receivers, and their small-diameter 24-hour dials are intended for services in which an accuracy of setting to the nearest quarter of an hour is sufficient. With a little practice in adjustment, however, they can no doubt be made to function to closer limits.

In the Type SSA time switch, made by Sangamo Weston, Ltd., Cambridge Road, Enfield, Middlesex, the single-pole switch is designed to break 10 amps. at 200/250 volts, 50 cycles. The clock mechanism is driven by a self-starting synchronous motor with fuses in both poles. Spare

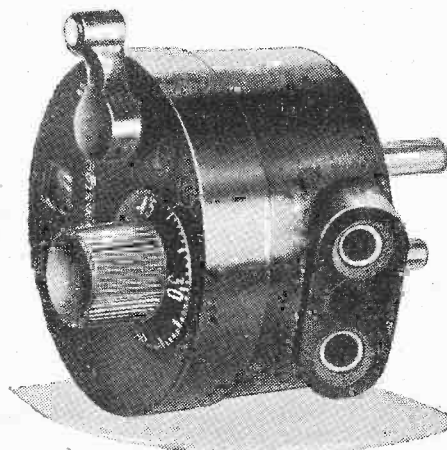

Switching intervals up to 12 hours may be set to the nearest minute with the "Chronostop" time switch.

trolling battery receivers. It is wound up by a dial calibrated in minutes, and for each complete turn of the knob the

Switching on the News—

fuses are incorporated in the switch. The 24-hour dial is calibrated at 15-minute intervals, and is normally supplied with one "on" and one "off" lever. A

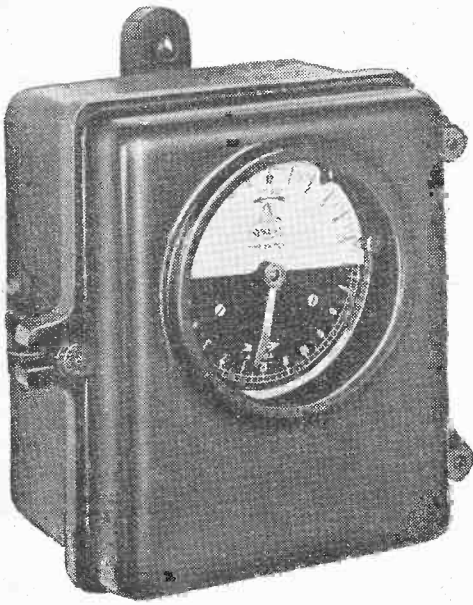

"Synclock" Model BO time switch. The same movement is available in a more compact round metal case.

moisture-proof moulded case with glass front encloses the mechanism, and the dimensions are approximately 3 $\frac{1}{4}$ in. diameter by 3 $\frac{1}{4}$ in. deep. The price is £2 16s. 3d.

The well-known Warren self-starting synchronous motor is used in the "Syn-clock" time switches made by Everett Edgcumbe and Co., Ltd., Colindale Works, London, N.W.9. These switches are designed for 200/250 volt, 50 cycle controlled frequency mains, and may be obtained with switch contacts for maximum currents of 5, 10 or 25 amps. The 24-hour dial is clearly subdivided at 15-minute intervals, and has black and white semicircles showing the night and day periods. The tripping riders are accessible, and special riders can be supplied where a shorter time interval than one hour is desired between the "on" and "off" settings. The price is £4, or £4 15s. if housed in a rectangular cast-iron case with scalable hinged cover.

While instruments of this type are more solidly built than is really necessary for the control of a wireless set indoors, their wide field of application gives them an intrinsic value which may well outlast their immediate use as programme selectors.

Inventors and the War

CHANGES IN PATENT LAW

CERTAIN important changes, arising out of the war, are foreshadowed in the Patents, Designs, Copyright and Trade Marks (Emergency) Bill recently presented to the House of Commons by the Attorney General.

Broadly speaking, they deal, first, with the position of enemy inventors who have already acquired patent rights in this country, or who seek to do so during the period of hostilities; and, secondly, with the difficulties of the British inventor who finds himself handicapped owing to war conditions in complying with the formalities to be observed in applying for a grant of Letters Patent.

It is common knowledge that, on the outbreak of war, all trading or other intercourse with the enemy is strictly forbidden, but the prohibition is to some extent relaxed in the case of matters relating to Patents, Designs, Trade Marks and Copyright.

Enemy Owned Patents

The first clause of the new Bill declares that, notwithstanding the provisions of the Trading with the Enemy Act, any licences issued under a patent shall not be held to be invalid simply because the patentee is an enemy; nor is any contract arising out of such licence held to be void owing to the fact that one of the parties to the contract is an enemy.

At the same time, the Comptroller of the Patent Office is given power, should the licensee under such a patent make application to him, either to revoke the enemy licence, or to vary the conditions attaching to the licence or to any contract made under it.

Any British or neutral manufacturer can

apply to the Comptroller to be granted a licence to work a German-owned patent; and if the Comptroller is satisfied that it is in the public interest that the patent should be exploited, and that the applicant is in a position to do so, he may grant a compulsory licence to him on any terms that he considers fit—irrespective of any other licence that may have been already granted by the enemy owner of the patent. But the Comptroller can revoke any such licence if it is afterwards shown to have been obtained by misrepresentation, or should the existing licensee fail to satisfy the reasonable requirements of the public for the patented goods at a reasonable price.

It is important to note that royalties (on a scale to be determined by the Comptroller) must be paid by any person who may obtain a licence to manufacture under an enemy-owned patent. They are not, however, paid direct to the enemy owner of the patent, but to an official who will be nominated by the Comptroller of the Patent Office. The moneys so collected are, in effect, placed under the control of the Crown, leaving their final destination to be determined when peace is declared.

Payment of Fees

Permission has been officially granted for the payment by British subjects of any fees that may be required either to obtain a German patent, or to maintain in force one already granted in that country. In the same way, authorised British agents may accept fees from German inventors who wish either to apply for Letters Patent in this country, or to preserve any rights that may have already been acquired.

Any correspondence with the enemy, re-

lating to such matters, must first be officially approved. For this purpose letters must be forwarded in the first instance to the Patent Office (enclosed in a stamped open envelope addressed to an intermediary in a "neutral country") under cover of a note explaining the circumstances. They should be addressed to: The Comptroller General, H.M. Patent Office, 25, Southampton Buildings, Chancery Lane, W.C.2, and the letters OB should be marked on the left-hand bottom corner of the outer envelope.

Would-be patentees are warned that they should not disclose information relating to any invention concerned with "Munitions of War," as defined in the Official Secrets Act.

They are also notified that the publication of accepted patents relating to subject-matter of war-like interest is likely to be suspended. Finally, it should be noted that it is necessary to obtain the approval of the Comptroller before proceeding with an application for a patent in any foreign country.

Extension of Time Limits

The Emergency Bill modifies the strict timetable which is normally enforced when an inventor is applying for patent rights. His complete specification, for instance, must, in the ordinary way, be filed not later than twelve months after his provisional, and renewal fees must be paid promptly as they fall due. And there are various other statutory time limits within which certain things must be done or the patent will lapse.

The Comptroller is now authorised to extend these time limits, as he may think fit, provided he is satisfied:—

(a) That the delay is due to the inventor or his agent—being on active service, or to other circumstances arising out of the state of war; or

(b) That owing to the war, the time limits normally imposed would operate unfairly to the interests of the inventor.

The last condition is particularly interesting. It is intended, among other things, to protect an inventor who, after having filed a provisional application, is prevented by war service from fully developing his ideas in the time normally allowed for putting in a complete specification. In such a case the usual limitation of twelve months goes by the board, and the inventor will be entitled to retain the original date of his provisional application so long as he files his complete specification a reasonable time after hostilities have ceased.

The Wireless Engineer

A TECHNICAL survey of the National Wireless Exhibition, the period of which at Olympia was unfortunately curtailed, is included in the October issue of *The Wireless Engineer*, which is published on the first of the month. An investigation of the screened loop type of receiving aerial as used in direction-finding and field-strength measurement is also described in an article in this issue.

A monthly feature of *The Wireless Engineer*, which is obtainable from booksellers or the publishers, Dorset House, Stamford Street, London, S.E.1, price 2s. 6d., is the Abstracts and References section compiled by the Radio Research Board. In this section are given abstracts of articles on wireless and allied subjects published in the world's technical press.

Anti-harmonic Filters

THEIR USES IN REDUCING RADIATION

By A. G. CHAMBERS, A.I.W.T. (G5NO) and W. BACON, B.Sc. (Eng.)

IN a previous article, written by the first author, reduction in harmonic radiation from transmitters by careful design of the transmitter and its associated coupling to the aerial was discussed. The present article is intended to carry the suppression to a further stage by use of a filter.

A filter consists of a network of induct-

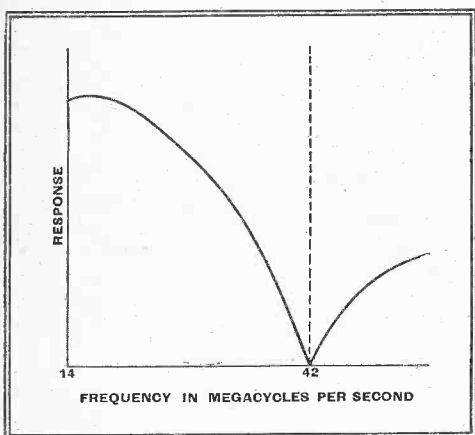

Fig. 1.—Characteristics of a filter designed for maximum attenuation at 42 Mc/s.

ances and condensers which, when placed in a circuit, attenuates certain frequencies more than others. There are three general types: low, high, and band-pass, the first being the one in which we are at present interested. This type of filter passes the lower frequencies—in our particular case the fundamental transmitting frequency—but attenuates, or does not pass, frequencies higher than a predetermined cut-off value. These higher frequencies are, of course, the harmonics that we are setting out to suppress.

The low-pass, or π , filter may be modified to a filter in which one particular frequency is attenuated. This filter finds its use in very stubborn cases of interference in the television band, but it was felt that if the harmonics had already been reduced to a small amount the low-pass filter would remove the balance, which is in-

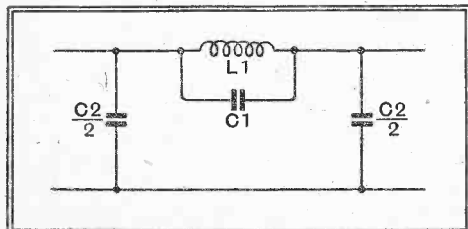

Fig. 2.—Circuit arrangement giving the response curve of Fig. 1.

initely more useful than the removal of one.

The transmission characteristic of this filter is shown in Fig. 1. It will be seen that the attenuation is a maximum at

42 Mc/s, this being the frequency at which interference is being experienced. The schematic diagram of this filter is shown in its fundamental form in Fig. 2. This, however, may be modified as shown in Fig. 3 for a balanced circuit.

These, and filters which follow, are for use only where the feeding system consists of transmission lines of known impedance, such as twin flex, cabtyre, open wire, or any of the commercial types now on the market. Fig. 4 shows how the filter is connected up to a transmitter.

The component values may be calculated from the following formulae:—

$$a = \frac{f_{\infty}}{f_c}, L = \frac{Z}{\pi f_c}, c = \frac{1}{\pi f_c Z}, m = \sqrt{1 - \frac{1}{a^2}}$$

$$L_1 = mL, C_1 = \frac{1 - m^2}{4m} C, C_2 = mC, \text{ where}$$

Z = the characteristic impedance of the line, f_c = the cut-off frequency, f_{∞} = fre-

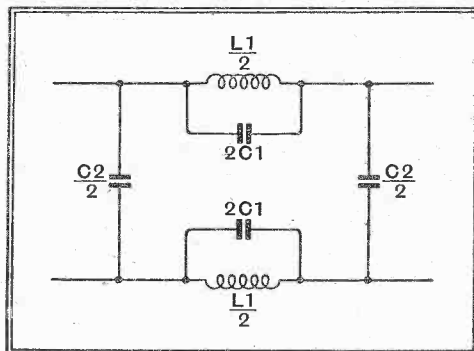

Fig. 3.—Filter of Fig. 1 modified for a balanced circuit.

quency of harmonic to be suppressed, or frequency of infinite attenuation.

Further details in design may be obtained from the new handbook published by the Radio Society of Great Britain.

The low-pass filter, which appears to be of greater value in that it suppresses all harmonics, should prove valuable to amateur transmitters operating on the lower frequency bands, where harmonics may be radiated, not only in amateur bands higher in frequency, but also at frequencies likely to interfere with commercial and other services.

The first filter of this type tried out took the form of Fig. 5. Although attenuation took place as expected, it was found not to be sufficient, so an extra section was added, as shown in Fig. 6.

ALTHOUGH this article must at the present time be regarded as of purely academic interest, so far as amateur transmission is concerned, the subject it deals with is of considerable importance from many points of view.

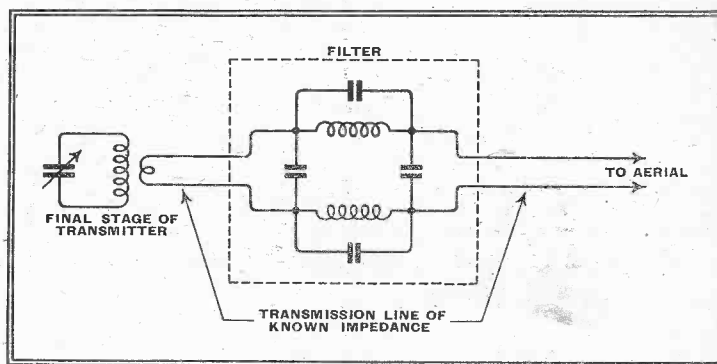

Fig. 4.—Showing how an anti-harmonic filter is inserted in the aerial feeder.

This new filter, however, proved to be too critical to adjust. Component values had to be set to within plus or minus 1/2 per cent. of the calculated figures for it to work well. It was realised that this would be an impracticable arrangement and that it was clearly desirable to have some type of filter the properties of which do not depend too greatly on the impedance into which it has to work.

Constant Impedance

This condition may be satisfied by choosing the component values such that at the working frequency there is a standing half-wave on the filter. If we imagine the filter to be a continuous length of line (instead of a number of lumped components), the current and voltage diagrams would be as below Fig. 7 (a). By doing this the impedance is kept more or less constant, since the value of current and voltage at the input must be the same as the value of current and voltage at the output. (The voltage will be in opposite phase, but this does not matter.) The

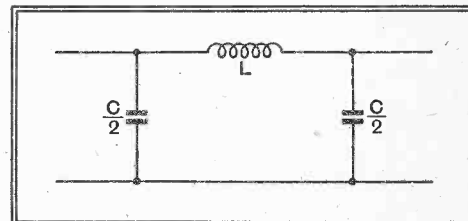

Fig. 5.—A simple low-pass filter which was found to give insufficient attenuation.

maximum value of these waves, however, depends upon the impedance into which the filter is working. If this is correct—i.e., equal to the characteristic impedance of the filter—there will be no standing

Anti-harmonic Filters—

wave at all; as we proceed further and further from correct matching the wave becomes greater and greater. Under these conditions the filter will stand a considerable mismatch without seriously affecting the characteristic, which takes the form shown in Fig. 7 (b).

This filter was built up and tried out on the 21-metre band. At a distance of about two miles the harmonic signal on 10 metres, originally QSA5 R7, was changed to QSA3 R2 with the filter inserted. At a distance of about 100 yards, on the television band, a QSA5 R7 signal

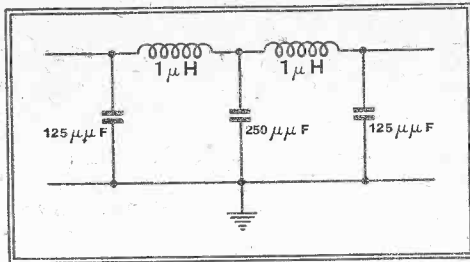

Fig. 8.—Filter used on the 14-Mc/s band.

able to screen the condensers, but this is not so important. The Q of the coils must

be kept high, and the quality of the condensers must be of a high order, otherwise the cut-off of the filter will not be sharp.

In the filter built up, condensers used were of the sprayed mica type. The coils consisted of 10 turns, 3/4 in. diameter, 1 1/2 in. long, wound with 14 SWG copper wire. When placed in a copper box measuring 4 1/2 x 4 x 3 1/2, these had an inductance of approximately 1 μH.

The authors wish to express their thanks to both G5QN and G8FK for their kind assistance while making tests on harmonic suppression over the air.

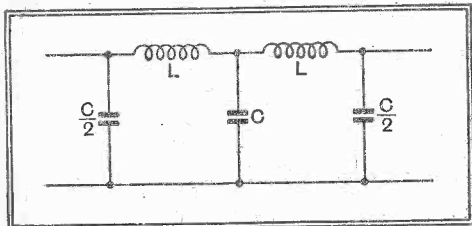
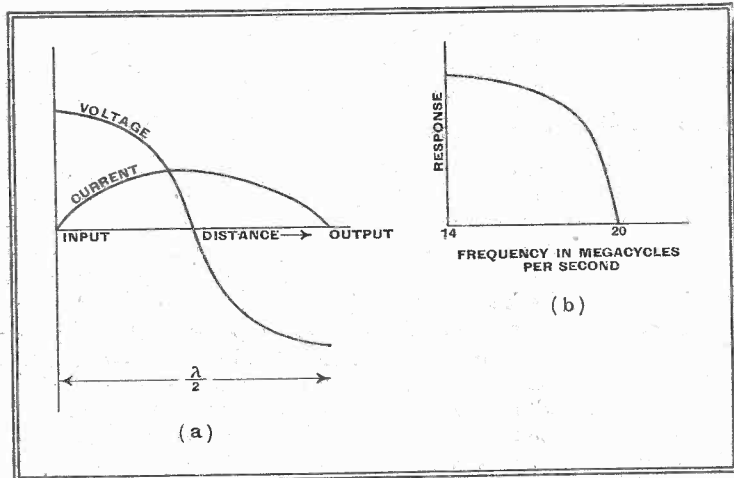

Fig. 6.—Low-pass filter with an extra section.

was changed to QSA3 R4 when the filter was incorporated. It was felt, however, that the filter would be very much more effective at the lower frequencies, and that if interference to television alone is experienced, perhaps the first type of filter might prove to be the most effective.

Fig. 7.—Diagram (a) shows current and voltage distribution along a half-wave line. The response curve (b) shows attenuation obtained with a filter of the type discussed in the text.



For those who are interested in this latter filter the design formulæ now follow:—

Fig. 8 shows the filter in its completed form. $L = \frac{Z_0}{\omega}$ and $C = \frac{2}{\omega Z_0}$ where $L =$ inductance in henrys, $C =$ capacitance in farads, $\omega = 2\pi f$, where $f =$ the operating frequency, $Z_0 =$ line surge impedance.

Design for 90-ohm Cable

The cable used by the authors was cabtyre, which has an impedance between 75 and 100 ohms. A figure of 90 ohms was taken as a mean. The operating frequency of the transmitter was 14,050 k/cs. We thus have:—

$$C = \frac{2 \times 10^{12}}{2\pi \cdot 14.05 \times 90 \times 10^6} = 250 \mu\mu f$$

$$L = \frac{90 \times 10^6}{2\pi \cdot 14.05 \times 10^6} = 1.02 \mu H$$

$$\therefore \frac{C}{2} = 125 \mu\mu f$$

It should be pointed out that screening is essential between coils, and it is advis-

Henry Jarrad's
PROBLEM CORNER

No. 39.—Unaccountable Motor-Boating

All-Hallows School,
Berkhamsted.

Dear Henry,
You remember last term I was making

every component and the current in every circuit, and it is perfectly O.K. The transformers, for once, are not junk; on the contrary, due to a temporary relaxation of financial stringency they are extremely high-class ones, guaranteed balanced for push-pull. The valves are also well matched—37 and 39 mA. The trouble is motor-boating. It continues to motor-boat when the first valve is withdrawn, also (and much harder) when *one* of the push-pull valves is out. (Yes, Henry, I only did it for a moment or two, so the other valve wouldn't get damaged!). There is no decoupling, but then it oughtn't to be necessary, surely, with a well-balanced push-pull output. Especially when the first valve doesn't seem to be coming into it.

I'd swear there is nothing wrong with the thing; but perhaps you can see it straight away. If so, I'd be jolly glad if you let me know what.

Yours ever,
Tony.

What is the probable cause of the motor-boating, and how can it most simply be cured? Solution on p. 300.

National Wireless Register

WILL any readers who completed the National Wireless Register form which appeared in *The Wireless World* and who have changed their addresses since sending in the form, please notify any such change at once to:—

The Secretary,
Wireless Telegraphy Board,
c/o The Admiralty,
Whitehall,
London, S.W.1.

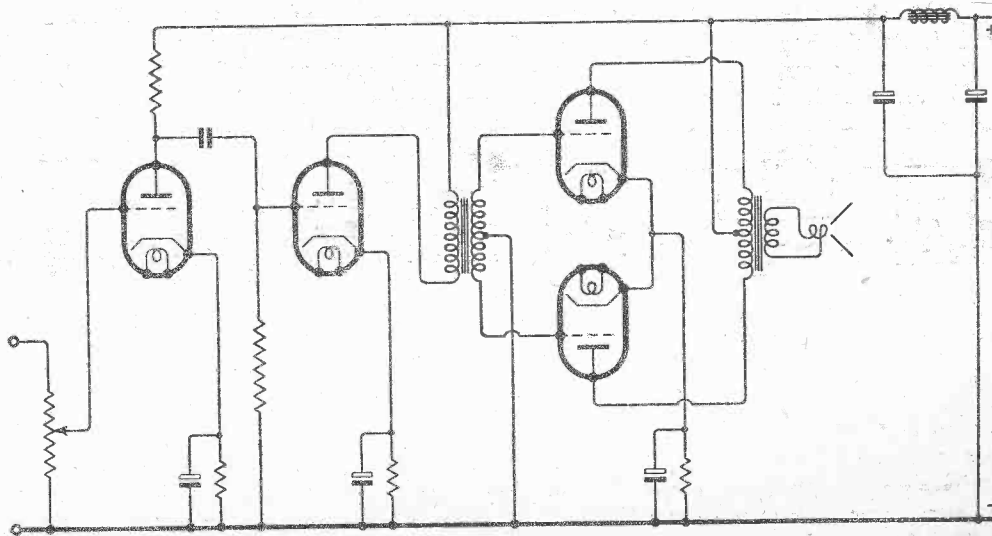

This is the circuit diagram of Tony's amplifier.

NEWS OF THE WEEK

FREQUENCY MODULATION IN U.S.A.

On a Commercial Basis

THE first manufacturer to be granted a licence for the production of frequency-modulation transmitters and receivers is the International General Electric Company of Schenectady, U.S.A. The company is now placing on the American market three types of receivers for the reception of frequency-modulation transmissions.

The cheapest, which costs \$60, is an 8-valve table model receiver exclusively for the reception of F-M transmissions, and therefore covers the frequency band of 39-44 Mc/s. The console model of this receiver costs \$100.

The third, which costs \$200, is a 13-valve receiver which covers the ordinary amplitude-modulation transmissions (540-22,000 kc/s) in addition to the frequency-modulation band mentioned above.

The company has also completed the engineering work on four sizes of frequency-modulation transmitters which it is hoped will soon be available; these have a power of 250 watts, 1 kW, 10 kW and 50 kW.

Readers will remember that the principal advantages of frequency-modulation are reception virtually free from atmospheric and man-made interference, and the possibility of employing high-fidelity transmission.

Transmissions from the 50-kW station of the inventor of the system, Major E. H. Armstrong, at Alpine, N.J., which uses a 400ft. turnstile aerial, are said to have a reliable range of over 100 miles. In addition to

this station which serves the New York City area, there is now in operation a powerful station near Boston which serves that Metropolitan area and also a low-power transmitter in Meridan, Conn. Early this autumn a powerful transmitter in Schenectady will also begin transmissions.

It is pointed out by Dr. W. R. G. Baker, head of General Electric's radio and television division, that for a long time to come frequency-modulation will be included in receivers as just "another band."

40-METRE BROADCASTING

UNABLE to find clear channels in the crowded short-wave spectrum, some of the belligerent powers have been operating transmitters in the only unoccupied frequencies available—the amateur bands. This follows the precedent adopted by the two sides in the Spanish Civil War.

Nearly all of the bulletins emanating from Warsaw, and re-radiated by the B.B.C., have been transmitted on 7.19 Mc/s. As very little amateur transmission now exists in Europe—several neutral countries, as well as the belligerents, have closed their amateur stations—the 20- and 40-metre bands are virtually free of interference at the present time and are therefore ideally suited for emergency transmissions such as those from Warsaw.

THE RADIO INDUSTRY

Meeting Increased Production Costs

REALISING the importance of radio in the national life—particularly in these days of war—The Radio Manufacturers' Association, after giving careful consideration to the problems with which the radio industry is faced as a result of the present emergency, states that it is the intention of the industry to "carry on" to the best of its ability with the service which it is rendering to the community.

Difficulties of an unusual kind have to be met, and it is inevitable that costs of production will tend to increase.

It is unavoidable that this increase in production costs must be reflected in some rise in the prices of receivers and com-

ponents, but it is agreed that such price increases as do occur shall be limited to meeting the extra charges which may be placed upon the industry.

MR. SYDNEY EVERSHERD

THE name of Mr. Sydney Eversherd, who died on September 18th, will be remembered for his work in the development of Meggers for the testing of electrical insulation. In 1903 he became joint managing director of Eversherd and Vignoles, which position he relinquished on becoming chairman in 1924. He retired from the board in 1938.

COMMANDER OF THE "COURAGEOUS"

CAPTAIN W. T. MAKEIG-JONES, R.N., who it was learned with regret went down with his ship when the aircraft carrier, H.M.S. *Courageous*, was torpedoed on September 17th, served as a wireless officer on the staff of the Admiral, Second-in-command of the Grand Fleet, during the war of 1914-1918. He was qualifying as a torpedo officer at the outbreak of war in 1914, and he devoted himself to the study of wireless telegraphy, which was then a branch of the torpedo officer's activities. Prior to his promotion to captain in 1930 he served in the Signal Department of the Admiralty. An old friend and shipmate, writing in *The Times*, says of Captain Makeig-Jones: "Those under whom he served knew him as one on whom they could ever rely with complete confidence. We shall not often see his like again."

SETS FOR A.A. UNITS

IN reply to a question in the House of Commons, the Secretary of State for War announced that the trustees of the Nuffield Trust had agreed to provide a number of broadcast receivers for men in charge of anti-aircraft guns and searchlight sets in isolated places to relieve the tedium of their duties.

The distribution of these receivers is being undertaken by the Navy, Army and Air Force Institute. It is learned from the secretary of the Nuffield Fund for the Fighting Forces providing the receivers that they are battery operated portables made by two or three well-known manufacturers. It is, of course, impolitic to disclose where these sets will be installed.

STILL MORE LICENCES

THE increase in the number of receiving licences issued by the G.P.O. during the month of August was 24,768. The approximate number of licences in force at the end of August was 9,044,100, an increase of 354,912 in the year. 54,100 of the licences in force are issued to blind persons. It will be interesting to see how many licences are issued during September. The rush to purchase receivers has been extraordinary; it may be, however, that these have been largely for emergency use by licensed listeners.

COMMERCIAL STATIONS

IN the interests of Luxembourg's neutrality and at the request of the Government of the Grand Duchy the management of Radio-Luxembourg is closing down the station. Its wavelength has been used during the war by a foreign station.

It is learned from the International Broadcasting Company that Radio-Normandie is at present continuing transmissions of music and news bulletins.

The outbreak of war brought into operation a war clause in all the contracts booked with advertisers for programmes from the main commercial stations which provided for four weeks' notice of cessation.

DIRECTOR OF ARMY SIGNALS

LIEUTENANT - GENERAL SIR JOHN FOWLER, K.C.B., K.C.M.G., D.S.O., who died last Wednesday at the age of 75, will be remembered by those who served in the Royal Engineers during the Great War for the part he played in the development of communication on the Western Front, where he served as Director of Army Signals in France from the mobilisation of the British Expeditionary Force until May, 1919. It was in the R.E.s that he received his commission in 1886. When, after the War, the Royal Corps of Signals was formed he became its first Colonel Commandant.

EMERGENCY ADDRESSES

FURTHER additions to the lists of emergency addresses published in our last two issues are given below.

British Institute of Engineering Technology, "Stoneleigh," St. George's Avenue, Weybridge, Surrey.
 Chloride Electrical Storage Co., Ltd., London Exide and Drydex Sales Department, 178, Kew Road, Richmond, Surrey. (Tel.: Richmond 4490.)
 London Radio Supply Co., "Denwyn," Oxenden Wood Road, Chislefield, Kent.
 McMichael Radio, Ltd.—All business transferred to head office at Slough, Bucks. (Tel.: Slough 22311.)
 Marconi's Wireless Telegraph Co., Ltd., Great Baddow, Chelmsford, Essex. (Tel.: Great Baddow 191.)
 Masteradio, Ltd., 193, Rickmansworth Road, Watford, Herts. (Tel.: Watford 9885.)
 Mullard Wireless Service Co., Ltd., "Clevemede," Cleve Road, Goring, Reading Berks. (Tel.: Goring 283.)
 Sound Sales, Ltd., West Street, Farnham, Surrey. (Tel.: Farnham 5215.)
 Webbs Radio Emergency Depot, 58, Victoria Street, St. Albans, Herts. (Tel.: St. Albans 4924.)
 Wireless Retailers' Association, 138, Wood Lane, Osterley, Isleworth, Middlesex. (Tel.: Hounslow 2057.)

DUBILIER

MR. W. H. GOODMAN, founder and managing director of the Dubilier Condenser Company (1925), has, in view of his slow recovery from his recent severe illness resigned the post of managing director. Mr. F. H. McCrea has been appointed in his place with Mr. John Goodman as deputy managing director. Mr. P. R. Coursey is technical director.

Characteristic Impedance

By "CATHODE RAY"

—AND ALL THAT

READERS of *The Wireless World* include all grades from beginners to highly qualified radio engineers, and it would obviously be very tedious for the latter if all the technical terms in every article were explained on the spot so fully as to be intelligible to the former. In the more advanced articles it is necessary to assume a corresponding amount of technical knowledge. My own chief aim is to fill in the explanations that must perforce be "taken as read" in such articles. Criticisms and suggestions, by the way, are always welcome.

SOME DIFFICULT TERMS EXPLAINED

"The characteristic impedance of the aerial is of the order of 250 ohms, and, to avoid the losses which would result if this were connected direct to a 70-ohm feeder, a transforming device is required at the junction."—(*The Wireless World*, August 31st, 1939, page 207.)

The above quotation appears to have been a stumbling-block to some, with whom I have a good deal of sympathy, because one can know quite a lot about resistance and impedance without being able to see how a cable of unspecified length can be said to be 70 ohms, or how an aerial consisting of a few yards of substantial copper wire cut into well-insulated sections can possibly have an impedance of 250 ohms.

The whole answer to this is rather a long story, which, to be properly told, inevitably demands the use of sinhs and coshes and other strange oaths used by highbrow mathematicians. I hope to shed

(where present) reactance, which in turn is of two opposite kinds, capacitive and inductive. This matter was dealt with in the issues dated June 23rd and 30th, 1938.

Before considering what "characteristic impedance" is, it will be helpful to prepare the ground by disposing of a comparatively simple idea—that of impedance matching. According to the quotation, there is an aerial of 250 ohms and a feeder (connecting line or cable linking the aerial to the receiver

or transmitter) of 70 ohms, and it is implied that if these were directly connected to one another there would be losses. *In order to pass the maximum power from one part of a system to another, it is necessary for them to have equal impedance at the points of connection.* But because impedance is a complex thing let us talk about resistance instead. Fortunately, in many practical systems the impedance is nearly all resistance, so we won't go very far wrong. It is quite easy to prove the truth of the above equal-resistance principle by the use of algebra, but some people are more easily convinced by examples. To take one that is particularly simple because it is not even complicated by AC, suppose we have a 60-volt battery, with an internal resistance of 20 ohms. It is used to supply power to a circuit of which the resistance can be varied. The problem is to adjust the resistance so that the greatest power is obtained from the battery. Such a simple circuit hardly needs a diagram, but here it is in Fig. 1. The battery is represented by what is inside the dotted line—a resistanceless battery in series with a 20-ohm resistance, this figure representing a $\frac{1}{2}$ -ohm internal resistance per cell.

Ohms Law Again

To go to one extreme, let us make R equal to 0 (nil). By Ohm's Law the current is $\frac{60}{20}$, or 3 amps. The voltage across R is, of course, nil, because it is a dead short-circuit. The power in watts is, therefore, 3×0 , or nil. Going to the other extreme, make R infinity, or, in other words, an open circuit. There is no current, and although the full 60 volts is maintained across the terminals, the wattage is again zero. Now try a shot in the dark—10 ohms. Total resistance, $20 + 10$, 30 ohms. Current, $\frac{60}{30}$, 2 amps. Voltage across terminals, 2 (amps) \times 10 (ohms), 20 volts. Watts, 20×2 , 40. If you work out the result in the same way for a number

of other values of R, such as 15, 20, 25, 30, etc., you can plot them as a graph (see Fig. 2). From this it can be seen that the greatest power—45 watts—is delivered to R when R is equal to the internal resistance of the battery—20 ohms. An equal amount of power is wasted in the battery, so the efficiency is only 50 per cent. This is not necessarily the most suitable condition for all purposes. One may care to have less power at a higher efficiency, in which case R is made more than 20 ohms. In fact, it can be said that one always does care to do so, because any ordinary battery would be destroyed in a very short time by the above treatment.

Loudspeaker Matching

Turning to a more interesting example, in which AC power is involved, consider the output valve in a receiver. It has internal resistance—the AC anode resistance—and it supplies power to a loud speaker. The resistance of the valve is usually thousands of ohms; the loudspeaker coil may be only about 2 ohms

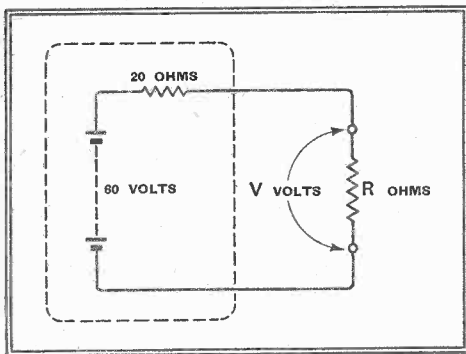

Fig. 1.—A battery (represented diagrammatically by the components within the dotted line) supplies power to a resistance R. What value of R draws the greatest power from the battery? See Fig. 2.

some light on the subject without recourse to such desperate measures, but to do even that much in a reasonable space it is necessary to assume a clear knowledge of what impedance means in the ordinary sense—a combination of resistance and

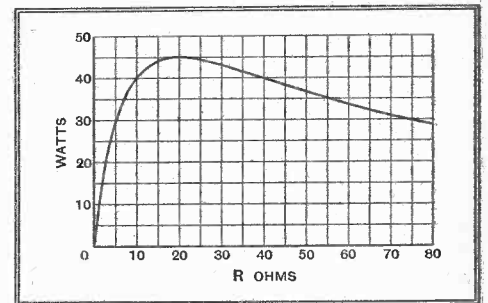

Fig. 2.—Working out values and plotting a graph, the value of R taking most power is equal to the internal resistance of the battery. This a perfectly general law, applying to all power systems, DC or AC.

AC resistance. Actually, it varies quite a lot, according to the frequency, but let's neglect that. If the speech coil were connected directly to the valve, or through a 1:1 ratio transformer, the efficiency would be very low indeed, and nearly all the power would be wasted in the valve. It can be shown, either in the proper algebraical way or by drawing a graph in the same manner as for the battery, that the greatest power is put into the loud speaker when its resistance is the same as that of the valve. As it is generally impracticable to make it so, a sort of liaison officer is employed for bringing the two together in the right relationship. It is the output transformer, or, as it might appropriately be termed here, the impedance-matching transformer.

I'm not going to be sidetracked into an exhaustive treatise on the theory of the

Characteristic Impedance—

transformer, however. Even if one's ideas on this subject are extremely elementary, they probably run to something like this: "A transformer is a thing for stepping

voltage up and current down, or *vice versa*." Taking a definite example again, a 1:2 transformer with 100 volts applied to the primary gives 200 volts from the secondary, and if 10 amps flow in the primary the secondary supplies 5. The power is the same both sides, so it must be assumed that the transformer itself consumes no power. Actually, large power transformers are made that are better than 99 per cent. perfect; valve output transformers never reach this standard. But we are neglecting subsidiary effects of this sort. The important thing to notice is that a doubling of voltage is (by Ohm's Law) a

doubling of resistance, and so is a halving of current. So when both things occur at once, the resistance is multiplied fourfold, or by the *square* of the step-up ratio. Therefore, if one wants to match an impedance of 1,000 ohms to one of 4,000 ohms, the correct transformer ratio is not 1:4, but the square root of this, 1:2. To match a 7,200-ohm valve to a 2-ohm load, the correct transformer ratio is $\sqrt{7,200:2}$, which is 60:1.

Actually, this ratio is correct for getting the maximum power, but is rarely

That, however, is by the way. The idea to grasp is that the 60:1 transformer makes the 2-ohm loud speaker look like 7,200 ohms to the valve, while it makes the valve look like 2 ohms to the speaker

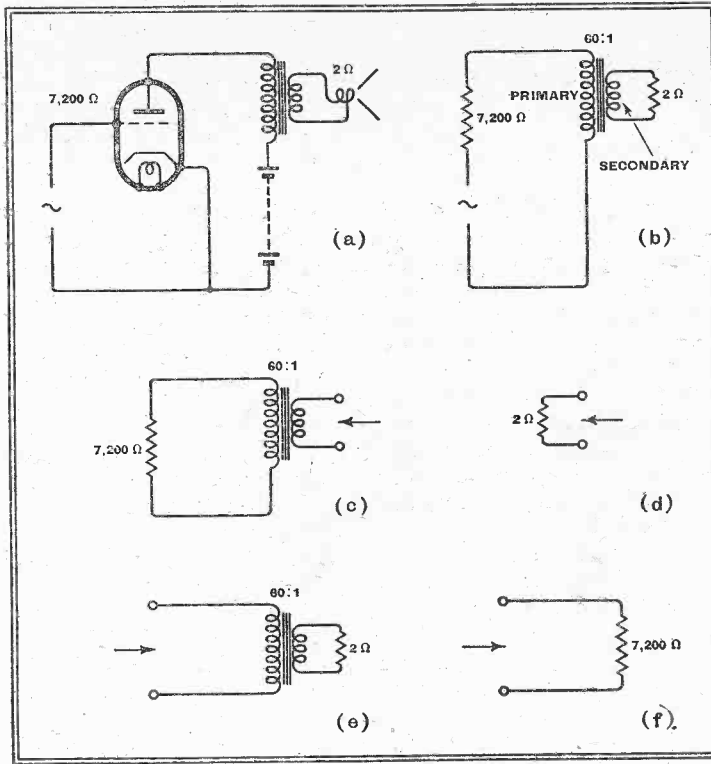
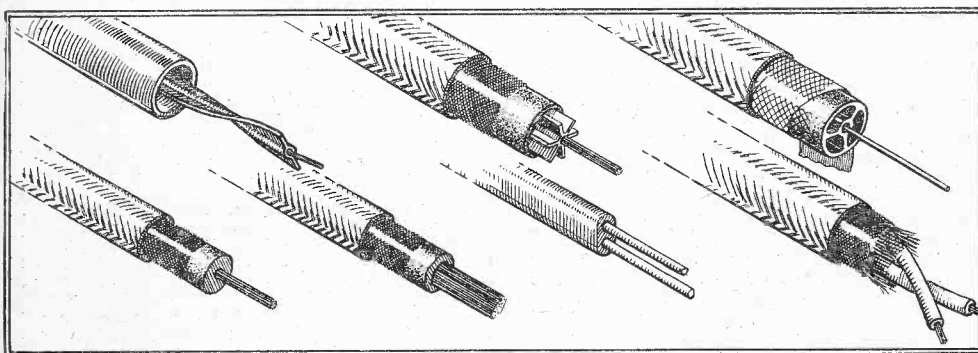

Fig. 3.—This familiar bit of circuit, (a), the output stage in a receiver, is electrically equivalent to (b), in the example chosen. The effect of the transformer is to make (c), looking in the direction of the arrow, equivalent to (d); and (e) to (f).

coil. Fig. 3 puts this in diagram form. The transformer itself has a very much higher impedance if nothing is connected to the other winding; in fact, if it were a perfect transformer it would have infinite impedance. But the load of 2 ohms connected to the secondary is the same as 7,200 ohms looking at it from the primary.

So far we have (I hope) assimilated (1) the necessity for matching the impedances of any two items which stand in the relation to one another of generator and load, and (2) the way in which im-



Characteristic impedance becomes a matter of importance when dealing with high-frequency cable, some of the various types of which are shown here.

adopted, because it takes no account of distortion. The ratio giving the greatest output power for a limited amount of distortion is obtained by using the "optimum load resistance" stated by the makers, instead of the valve resistance.

pedances can be matched. If maximum power transference is the object, the impedances ought to be equal; but often there are overriding considerations, as we have seen.

Now we are ready to look at the original

problem. A period will, however, be allowed for the fevered brow to cool in readiness for a renewal of the struggle.

(To be concluded.)

HENRY FARRAD'S SOLUTION

(See page 296)

THE general cause of motor-boating in amplifiers is, of course, the HT source having appreciable impedance and therefore varying in voltage in accordance with current variations in the output stage. These voltage variations are passed on to an earlier stage, amplified, and if in the right phase are liable to maintain the current variations continuously. When a filter condenser of large capacity is used across the HT source, it is only at very low frequencies—perhaps one or two cycles per second—that its impedance is high enough to cause this instability; hence "motor-boating."

One of the advantages of push-pull is that the currents in the two output valves are in opposite phase and neutralise one another so far as the HT source is concerned. This holds good only if the currents in the two valves are reasonably equal.

In the present case the first valve is not concerned in maintaining motor-boating, and one stage cannot do so on its own; therefore the feedback is occurring from the push-pull output stage, via the coupling condenser between the first two stages, to the grid of the second valve. Assuming that Tony's exhaustive tests, and the balancing of the transformers, can be depended upon, the output valves themselves must be unbalanced. The difference between 37 and 39 mA in the anode currents is not enough to worry about; but equality of the anode currents ensures merely *static* balance, which is desirable for preventing iron-core polarisation, but is not the thing that matters in avoiding motor-boating. What is needed is *dynamic* balance, that is to say, equality of the variable part of the anode currents. For some reason or another this is seldom considered; yet it is possible for valves having equal anode currents to have unequal mutual conductances, and thus to deliver unequal signal currents, the difference between which may be enough to cause motor-boating unless the previous stages are decoupled. Fortunately, there is an alternative to decoupling, for as "Cathode Ray" has pointed out,* the by-pass condenser across the common bias resistor in the push-pull stage not only serves no purpose if the valves are balanced (for there is then no resultant signal current to be by-passed), but if they are *not* dynamically balanced it prevents them from being so. Suppose that the upper valve has a greater mutual conductance than the lower one. Then there is a surplus signal current in the common cathode circuit. If the by-pass condenser is omitted, this current flows through the resistor and causes negative feedback which tends to reduce the amplification of the upper valve. But as the lower valve is in opposite phase, the signal voltage across the resistor gives *positive* feedback to it, increasing its amplification. In this way the strong valve is weakened and the weak valve strengthened, and so the lack of dynamic balance is largely counteracted.

All that Tony has to do, therefore, is to remove the by-pass condenser.

*April 30th, 1937: see also "Electric Gramophone," May 11th, 1939.

Whaling and Wireless

AN INTERESTING SIDE OF GERMANY'S WAR PREPARATIONS

IT seems generally agreed that victory in the present war, as in the case of the last one, will depend as much on the possession of material resources of various kinds as on military action. One of the principal materials required may be summed up in the word "fats." Germany realised the importance of fats long before the war began, and in her efforts to accumulate a store of this vitally necessary material used all the resources of science, including a novel application of wireless DF, which is dealt with in this article.

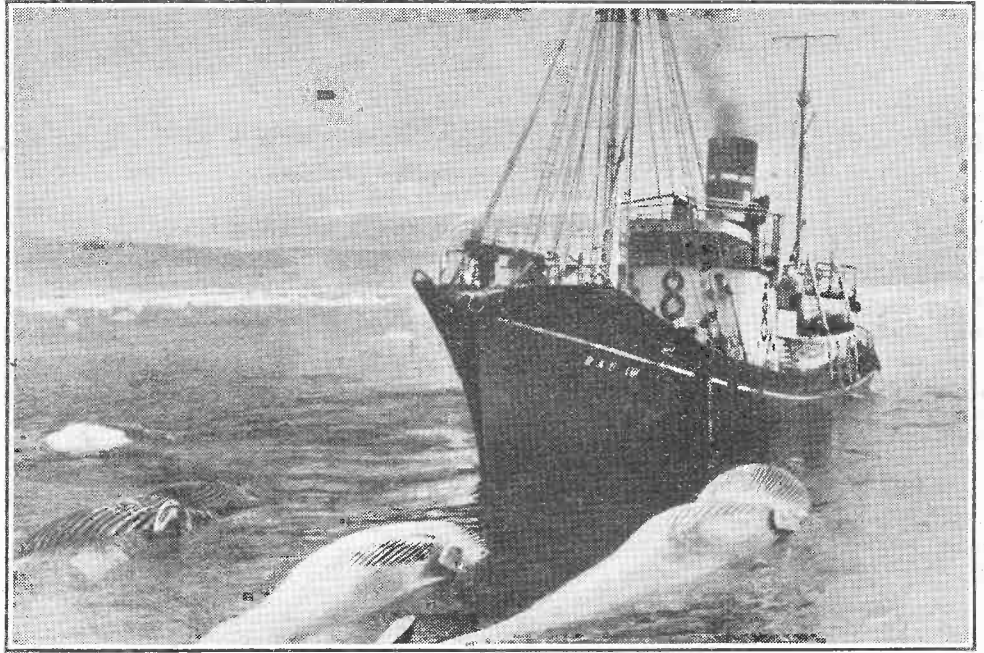

THE connection between DF and fats may not seem apparent at first sight, and even when the word "whales" is mentioned it is probable that the average person will think

of blubber, and then treat it by boiling in order to extract the necessary oil. In certain whaling fisheries it is customary to store the blubber in tanks and bring it to shore at the end of the voyage for the necessary treatment. This method, however, is usually only employed in what may be

termed short-voyage whalers operating principally in the Greenland seas. In the case of long-voyage ships, it is necessary to extract the oil on the actual ship, and this of course necessitates a great deal of work on board, and means that during the time a carcass is being treated the work of actual whale-catching is, of necessity, severely handicapped.

The Germans overcame this difficulty by fitting up large vessels of considerable tonnage—21,000 tons in the case of the latest types—as "factory" ships, in which the carcasses were treated. These floating factories did no actual whale catching, but were devoted to dealing with the carcasses caught by a fleet of eight whale chasers attending each mother ship. These whale chasers were quite small vessels, having a crew of only fifteen men

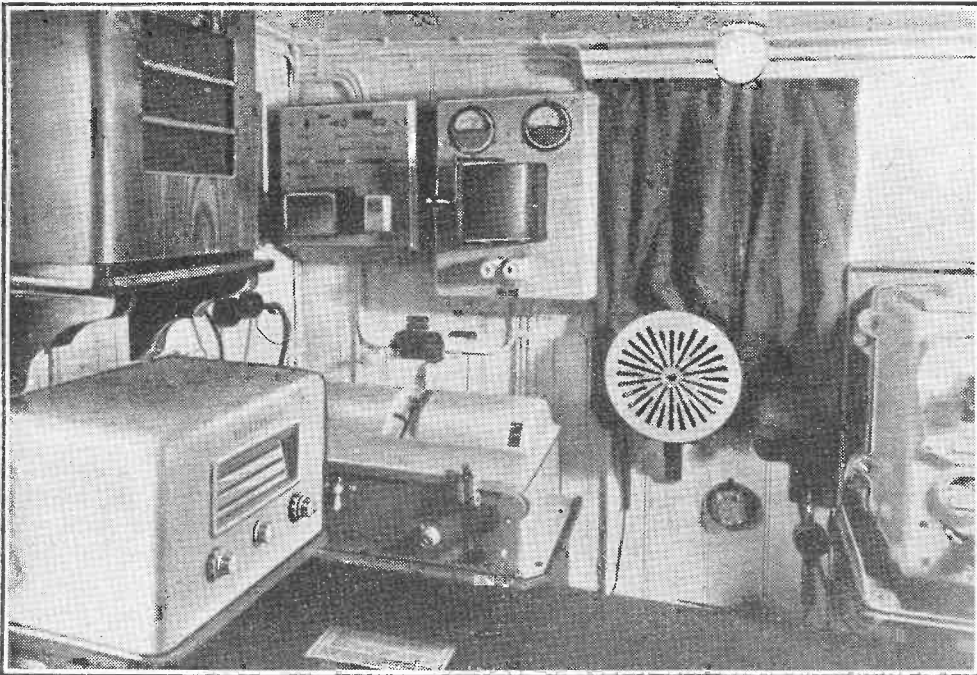

only of the use of DF for the navigation of whaling ships in foggy weather, and will never even guess at the highly ingenious way in which DF was actually employed by the Germans in the catching of whales in fair weather as much as in foul.

Most people are aware that when the whale has been caught and killed it is necessary to cut the blubber off the car-

The "hunter's" gear, shown above, was made as simple and foolproof as possible. In addition to the special DF transmitter, the carcass of the whale was invariably marked with a flag (right) in order to simplify the task of finding it.



Whaling and Wireless—

in contrast with the 350 men carried by each factory ship.

The complete whale-hunting unit, comprising factory ship and attendant chasers,

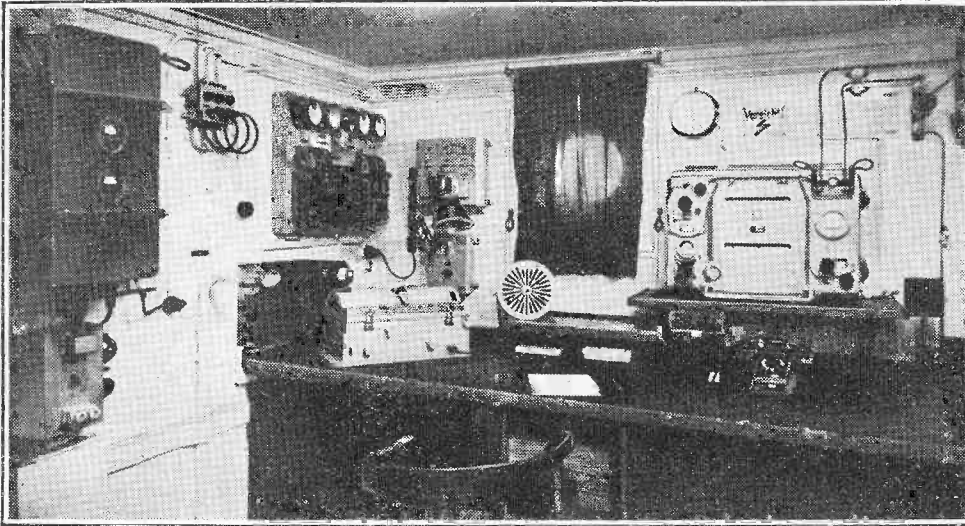

The apparatus on board the "mother" ship, which carried a skilled wireless operator, included both medium and SW transmitters and DF equipment and, in addition, the ship was equipped throughout with a PA installation through which broadcast or recorded programmes were fed.

would be away from home for several months at a time. The procedure was that when a chaser successfully harpooned a whale, if the mother ship was too far away for the whale to be towed to her, notification of the catch would be sent to her by wireless, and she would proceed to its position to pick it up.

The chaser did not, however, stand by the carcass but continued with her business of whale seeking. The carcass would naturally drift, and had it not been for an ingenious employment of DF would in most cases have never been discovered by the mother ship. To avoid this probability of loss, a special automatic wireless transmitter was fixed to the carcass by the whale chaser before she left it. This transmitter continued to send a signal automatically over a considerable period of time, and by taking DF bearings on the signal the mother ship eventually located the carcass.

Installation Details

Each mother ship was fitted with a 100-watt Telefunken transmitter working on various wavelengths between 100 and 800 metres. Two Lorenz SW transmitters were also carried, and, in addition, very comprehensive DF equipment was installed. The actual whale catchers were also equipped with a 100-watt transmitter and with a certain amount of DF gear, but carried no skilled operator, the duties of operating the radio usually devolving on the second mate. A skilled operator-cum-serviceman was employed on the factory ship, his duties including the servicing of the equipment on the catchers, and also the portable DF transmitters which were affixed to the carcasses of the whales.

The mother ship was also equipped with a comprehensive PA system for

distributing ordinary broadcasting programmes, and also concerts of gramophone records throughout the ship. As the ships were away from home for several months at a time it was usual to carry a large col-

lection of records. Broadcast programmes were also a feature of life on the small hunter boats.

Above Three Megacycles**CONDITIONS FOR SHORT-WAVE
NEWS GATHERING**

A KIND friend has sent me a cutting from the *Barbados Advocate*—adding that his thoughts on reading the article in question were more of sorrow—for radio manufacturers—than of anger.

It appears that a well-known British manufacturer claimed, as one of the outstanding points of his new receiver, now on sale in the West Indies generally, that it actually tuned down to the low wavelength of 18.5 metres!

The point, which is well known in the W. Indies, if not by cricket fans in this country, is that the B.B.C. broadcasts of the recent tour of the West Indian cricketers were received very well in the team's home islands on GSJ 13.9 metres, but were inaudible on higher wavelengths.

What is true of daylight transmission to the W. Indies is even more true for daylight (especially midday) transmission to S. America and S. Africa and also to a very large extent to India and the East.

No receiver that does not tune down to 16 metres should be made available for export—and with advantage the limit could well be made as low as 13 metres. For export to Africa the limit should be definitely 13 metres, since even if the manufacturer thinks that the approaching sunspot minimum may come to his rescue and eliminate the 13-metre band for a few years, it is quite possible that this may not prove to be the case for midday transmissions to Africa.

Even for the home market the recently instituted NBC station WRCA on 21.63 Mc/s in the 13-metre band has decidedly changed the position here.

This station, which appears to be using

higher power on a European beam, has during the past week, on occasion, been a strong signal until 7 p.m. G.M.T. (All times given in these notes are G.M.T., which, I need hardly remind you, is one hour behind British Summer Time.) Conditions during the period under review from September 14th to 21st have been variable, with 11-metre (25 Mc/s) U.S. transmitters audible in the early evenings at the beginning of the week, but at 9 p.m. on September 20th the only U.S. station audible was WGEO on 9.53 Mc/s.

Another point of interest was the use by W2XE of his new call sign WCBX from September 15th onwards, and the reappearance of what appears to be deliberate jamming on Moscow, especially on the 12-Mc/s transmissions (25 metres) from this station.

To review the period in detail, both WNBI and WCBX were excellent all the afternoon and evening on Thursday, September 14th, and at 7.20 p.m. two 26-Mc/s "high-fidelity" broadcasters could be heard.

At the same time Friday evening "W2XE" could be heard on the 13-metre band, apparently having brought his old low power transmitter into service again, since the WCBX (ex W2XE) transmitter was also a strong signal at this time on 17.83 Mc/s. A faint 26-Mc/s station was also intercepted. A bad heterodyne was noticed on WCBX 17.83 Mc/s at 9.15 p.m., but the CBS transmitter was easily 100 per cent. intelligible; this heterodyne disappeared at 9.30 p.m.

Other strong signals were WNBI and WGEA; the usual English news was taken from WCBX on 17.83 Mc/s at 9.50 p.m. following the multi-lingual news in Polish, German, Italian and French.

At 1 p.m. on Saturday, September 16th, WPIT Pittsburg was a full loud speaker signal on 21.54 Mc/s in the 13-metre band, but WNBI and WCBX were also good signals on 17 Mc/s.

A further 13-metre signal appeared on "W2XE" again on 21.52 Mc/s and this station was just audible at 6 p.m., carrying the same programme as WCBX.

Early news of the Russian advance into Poland was obtained from WCBX at noon on Sunday (but actually the B.B.C. had announced it an hour before). For some days previously the news from CBS and NBC had clearly foreshadowed this move.

A portent of forthcoming poor conditions was given by the rumble on both WNBI and WCBX's carriers. This proved to be true and by 9 p.m. Sunday only 9 Mc/s remained as a useful DX band.

Conditions on Monday evening were much better again and from 6.45-7 p.m. the new WRCA on 21.63 Mc/s was an excellent signal, taking the English Hour with WNBI.

The outstanding station from the "programme interest" point of view on Tuesday and Wednesday evenings was, I think, the German Freedom Station, working on 40.9 metres (at the high-frequency end of the amateur band). It was an excellent signal on both occasions—with a man announcing "Deutsche Freiheitsender." A phrase that particularly struck me on Tuesday came after a description of the devastation of Poland, "... und dieser man ist Hitler!"

Conditions deteriorated again badly on Wednesday evening, September 20th, and by 9.15 p.m. the only U.S. broadcaster audible was WGEO on 9.53 Mc/s.

"ETHACOMBER."

Accumulator Charging in the Wilds— gradually dwindle, as does that of the dry cell.

A larger battery on the same lines was next made up, as shown in Fig. 3, and this passed nearly 0.75 amp. on short-circuit, with 1.1 volt on open-circuit. The internal resistance is therefore about 1.3 ohms, and the optimum load is between 0.3 and 0.4 amp. With this current the voltage is about 0.5 per cell, and six cells in series therefore would be required to charge a 2-volt accumulator. By making up 12 cells and connecting them in 6-series 2-parallel, nearly an ampere would be available for charging.

In the experiment this cell was left short-circuited for 24 hours, and at the end of that time the voltage on open-circuit was still about 1.1, and the current had slightly increased—no doubt owing to the formation of sulphuric acid, which lowered the internal resistance. At the time of writing it is still short-circuited, and no change is discernible. From the data given in old books, it is estimated that this cell has a capacity at the above rate of discharge of about 50 ampere-hours, so that it could charge two 20-ampere-hour accumulators.

Reasonable Cost

Costs seem to be reasonable. Commercial copper sulphate, known as "blue-stone" or "blue vitriol," is used in agriculture, and can be bought in 1 lb. packets for 4½d. Commercial quality zinc sulphate costs 8d. a lb. About ¼ lb. or less of each were used in making up the jam-pot cell, and to this must be added 2d. or 3d. for zinc and copper, the latter being practically everlasting. Probably rod. would cover the cost of making the cell initially, and about 7d. for renewing the salts and zinc subsequently. Hence the cost per accumulator charge works out at about 1s. 4d. for a 20-Ah accumulator (capacity rated at 10-hour rate). These estimates are made, of course, with reserve, and are merely indications to encourage those who, with sunhelmets and dinner jackets, uphold the traditions of Empire and want to keep in touch with the homeland in romantic foreign parts. For those in the English countryside it would probably be cheaper to take the old accumulator in to the nearest town and have it charged at the local garage for a few pence.

The Gravity Daniel cell is simple enough to understand and construct, but for those used to accumulators and to whom primary batteries are museum curiosities, the following hints are offered.

The action in a Daniel cell is represented chemically by the equations

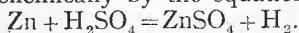

The H_2 in nascent state goes to the copper plate which is surrounded by CuSO_4 , and there it combines with the acid radicle forming H_2SO_4 , and Cu is deposited on the copper plate. Now, H_2SO_4 violently attacks zinc unless it is chemically pure, but this pure state may be simulated by rubbing the surface of the zinc with mercury—a not inexpensive process.

Hence zinc sulphate is used as the exciting fluid, and no local action takes place. The chemical reactions with zinc sulphate exciter are less obvious, and it seems probable that the cell only operates because of traces of free acid in the commercial salts used. This is borne out by the fact that Daniel cells can be made up with only water as the exciter, but such cells have to be short-circuited for some time before they operate efficiently. If any free acid is present, the hydrogen from it when it attacks the zinc combines with the copper sulphate to form fresh acid. It is extremely important that no copper sulphate reaches the zinc, and to avoid this in the Gravity type of cell, the construction is

as shown, and the zinc sulphate, dissolved in water to form a saturated solution, is poured into the cell *very gently* so as not to disturb the copper sulphate crystals. A hydrometer syringe is handy for this operation. If the cell is made up complete in the dry state, with the electrodes and the copper sulphate crystals, and the glass-wool and paper separator all in position, the addition of zinc sulphate solution only is required to make the cell ready. It is not, of course, transportable. If the initial current seems unduly low, the addition of a teaspoonful of dilute accumulator acid will reduce the internal resistance sufficiently for the proper current to be passed.

Random Radiations

By "DIALLIST"

A Friend in Need

WE wireless folk usually manage to come across fellow enthusiasts, no matter where we may be. At the moment I'm billeted in a tiny village, which consists of the pub., two large farmhouses and a score of cottages, all clustering round the village green; there is also a delightful old vicarage close to the church, which is about a quarter of a mile away from the green—I've often wondered why one so often finds the church not in but on the outskirts of an English village. As the possessor of a mains short-wave set which can't be used, because the only electric lighting current is home-made and of the 50-volt DC variety, I was bemoaning my tantalising fate when kindly providence came to my aid. I overheard two fellows discussing wireless, and gathered from what they said that one of them was almost as anxious as I was to do some short-wave listening. He had a battery "all-wave" receiver, but was lamenting that he found it terribly difficult to tune on its short-wave range. Rather diffidently, I joined in the discussion, and, when the opportunity arose, inquired if I might try my hand on the knobs. 'Twas a case of "granted as soon as asked"; two minutes later we were on our way to the house where the set was installed, and when I mention that those two minutes were spent in ensuring that there were no heeltaps, you'll deduce that the house was not the vicarage. Arrived there I found a not very ancient receiver of a type that I'd handled several times before. It *isn't* easy to tune on the 17-megacycle and 15-megacycle bands; but old stagers like myself who cut their DX teeth on the extension-handled knobs of early straight short-wave sets have acquired as a result of long practice the knack of making hair's breadth movements of tuning controls.

Thrills

It wasn't long before we had found a good selection of European stations and one or two in America as well. And what a joy it was to feel oneself in touch with the world again. If you're used to being able to pick up SW stations at will, you don't realise, until you have been deprived of them for a week or two, how much of your normal life the ability to hear news from all over the world had become. Perhaps in normal times it would not be so bad, for the newspapers supply one's most urgent needs. But with

the morning papers cut down to half their normal size and evening papers unobtainable, unless someone happens to have motored down from London and brought one with him, you feel that you have lost the familiar contacts with other countries. I can assure you that the first news bulletin in English from a far-away station, after such a period of deprivation and in such times as these, gives you a thrill nearly as great as that produced aeons ago by the hearing of your first transatlantic station.

A Selection

It was surprising to find comparatively little jamming on the short waves. The only undoubtedly genuine instance I came across occurred when the "Freiheitsender," the much hunted "agin the government" German radio station, was blotted out. But even that didn't happen until the announcer of the Freiheitsender had been telling those who run Germany where they got off—or rather where he hoped they would get off—for quite a considerable time. The Italian news bulletin struck one as being remarkably straightforward and impartial. Some of the items from Berlin were comic in their exaggerations. It was amusing to find their accounts of a milk famine in Britain coming almost on the heels of a plea from our Ministry of Health for every household to drink more milk. I'd hoped to strike some of the talks from observers in European countries that are relayed by American short-wave stations, but there were none of them going at the time. Not much of a bag, the short-wave man may say. In a way it wasn't: there was nothing worth entering in a SW log, for there were no notable captures; but I enjoyed that hour with the indifferent "all-wave" receiver as much as I've ever enjoyed any hour at the controls of any set. My only regret is that my newly-made radio friend is but a bird of passage. He leaves the village to-morrow—and takes the set with him. I hope I'll be able to find another enthusiast.

Carrying On

TAKE to heart the advice to fill in an order form for *The Wireless World*. Last week I couldn't get into the nearest town until Saturday. Arrived there I went into the first big newsagents I saw, slapped

Important Announcement

The **Wireless World** to be Published as a **MONTHLY**

After the present issue, this journal will appear as a monthly publication with more pages, and in a more compact size. The price will be one shilling.

The next issue will be on sale on Friday, October 20th, and thereafter the journal will be issued on the 20th of each month.

It is vitally important that a definite order should be given to newsagents, and a form for this purpose is inserted in this issue.

NEW SUBSCRIPTION RATES, INCLUDING POSTAGE FOR HOME OR ABROAD:
12 months, 14/- ; 6 months, 7/- ; 3 months, 3/6

down my sixpence and asked confidently for W.W. "Sold out," I was told; and it was the same tale at half a dozen other shops. I had a long and weary walk before I managed to track down a copy; in fact I was so sick of tramping pavements that I'd willingly have paid double-price for it. If you're on service, take my tip and subscribe for your copy to be sent by post. It's more than likely that you will be moved about from place to place, and if you are it is a simple business to send a post card with your change of address. Thus you make sure of getting your copy each week, and of missing nothing. If you rely on casual purchases you'll find one of these days that you can't get a particular issue; and when the next comes along it's ten to one on your finding that it contains part two of some important article. There are few things more annoying than to be minus part one of an article whose part two is more or less incomprehensible without it. W.W. carried bravely on through the last war under its old name. It's up to us to see that it can fulfil its resolve to do the same in this war. We can't do without it, and it can't do without us.

stations on the medium and the long waves are hopeless. When such folk decided that the times demanded an overhaul and a new outfit of valves, they found that the overhaul might take some time and possibly that the required valves were unobtainable without some delay. In any case, the cost would be more than the ancient set was worth. Hence, they decided, wisely if rather late in the day, to go in for a new receiver. Secondly, there were many people who realise the importance of short-wave reception nowadays, and are not satisfied with the rather crude SW ranges of their existing sets. Some of these are buying "broadcast" sets with better short-wave tuning arrangements and performance; others are attracted by the purely short-wave set or the communication receiver. Well, it's an ill wind that blows nobody good. Both the industry and the public will benefit by the discarding of antediluvian sets that ought to have gone the way of all rubbish long ago. Apart from the matter of complete receivers, there is also the question of components and accessories; for these I can foresee a good demand. Sets must be adapted to changing conditions, and must be kept in the best possible trim.

Components

NO IMMEDIATE SHORTAGE FOR THE HOME CONSTRUCTOR

NO doubt many readers have been wondering what the position will be regarding the supply of components for home constructors. The demands of the Services naturally have priority, but when things have settled down it is reasonable to expect that the manufacturing resources of most of the leading firms will allow a sufficient margin to fulfil the needs of the home constructor.

In the meantime it is gratifying to learn that everything in the 1939/40 catalogue of A. F. Bulgin and Co., Ltd., is available. That being so, the amateur should not be held up for anything he may require to build or complete his own receiver.

The new list is even more comprehensive than usual and includes equivalent components for most of the products of the specialist firms. Its fully illustrated 128 pages contain much useful technical information. Copies are obtainable, price 3d., from Bulgin's head office, Abbey Road, Barking.

The Boomlet

AMAZING what a run there has been on wireless sets since the war broke out. And it still goes on. I was told in one shop the other day that they had disposed of every new and second-hand battery receiver in the place and could sell dozens more, were they obtainable. The greatest demand has been for battery sets, for a variety of reasons. Some people feared for some queer reason that mains current supplies might be cut off; others were afraid that they'd have difficulty in making do with the rationed mains current (they won't—or shouldn't—as I pointed out recently in these notes); some wanted sets for use in shelters or dug-outs unprovided with lighting mains; some were likely to move from place to place and thought it wise to purchase, whilst they were obtainable, receivers that could be used anywhere. But the boomlet has extended to mains receivers too, though not to quite such a marked extent. When I asked who was buying new mains receivers I was told that buyers were of two main kinds. There are first of all those who have been hanging on to old sets (usually with the original valves in the holders) until reproduction has become so bad that the Home news bulletins are all but unintelligible, and foreign

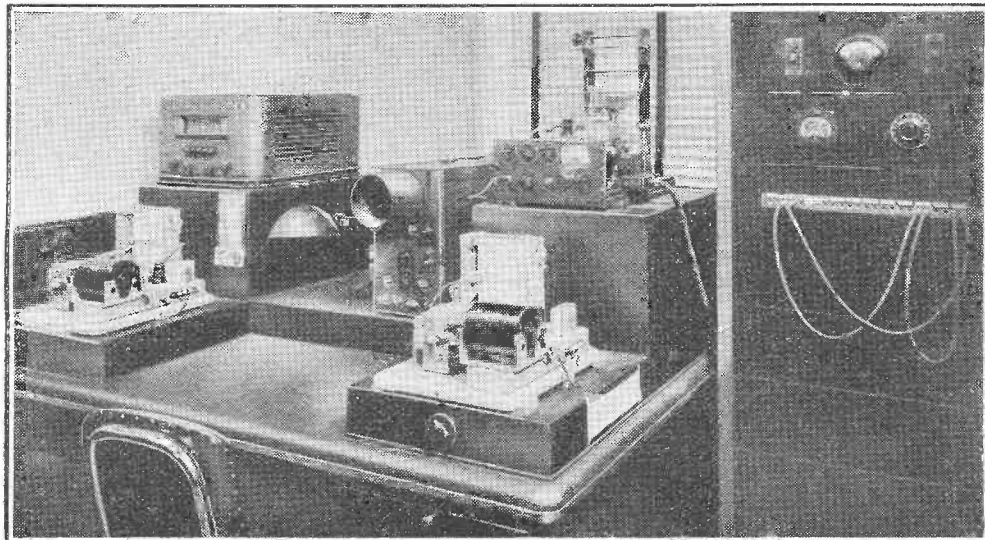

FACSIMILE TRANSMITTER. This photograph shows the apparatus installed at station WLW, Cincinnati, U.S.A., for the transmission of "radio newspapers." In the centre background is the scanner, with monitoring printer and oscilloscope in front and to the left respectively. Impulses from the scanner are passed to the line amplifier mounted in the rack on the extreme right, and the output of this amplifier is used to modulate the transmitter. Further monitoring is provided by the domestic broadcast receiver (extreme left) which operates a printer of the type designed for use in the home of subscribers to the facsimile service.

GOODMANS

LOUDSPEAKERS for A.R.P.

PUBLIC ADDRESS LOUDSPEAKERS

CABINET LOUDSPEAKERS

LOUDSPEAKER UNITS

also

MOVING-COIL MICROPHONES

(Chassis Type)

If particulars of your requirements are sent immediately adequate stocks are still available.

GOODMANS INDUSTRIES, LTD., Lancelot Rd., Wembley, Middx. Phone: WEMbley 4001 (5 lines)

AMBASSADOR

ALWAYS

FINEST PERFORMANCE & VALUE

Send for details

MODEL 6779

CASH PRICE

£11

with Valves and Speaker A.C. ONLY

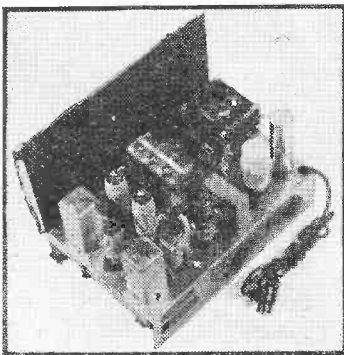

SPECIFICATION:

Six valve super-het chassis using MAZDA Octal valves. Powerful R.F. stage on all bands covering 12.5/52 metres, 175/550 metres, 1,000/2,000 metres. Large plate glass dial. Electrical Band Spreading. Sensitivity control. New High Speed A.V.C. Automatic distortion cancellation. Electro dynamic reproducer with 40/8,000 response. 6.8 watts output. Heavy plated chassis total weight 37 lbs.

Wholesale and Export Enquiries Invited
AMBASSADOR RADIO WORKS
HUTCHINSON LANE,
BRIGHOUSE, YORKS

Telephone: 283

RADIOMART

G.S.N.I. (BHAM) LTD.

THE SHORT-WAVE SPECIALISTS

SPECIAL OFFER!!!
Fully shrouded Transformers by America's largest manufacturer. While they last.

All 250 v. primary and fully impregnated.	
T29708-375/375 v. 150 m/A., 6.3V3A, 2.5V3A, 5V3A.	15/-
T19610-350/350 v. 150 m/A., 2.5V6A, 2.5V2A, 5V3A.	12/6
T7236-375/375 v. 120 m/A., 6.3VCT, 4A, 5V3A.	10/6
T7236-350/350 v. 100 m/A., 6.3VCT, 3A, 5V3A.	8/6
T7307-350/350 v. 80 m/A., 6.3VCT, 3A, 5V3A.	7/6
T7009-320/320 v. 80 m/A., 6.3V4A, 5V3A.	7/6
T6025-320/320 v. 80 m/A., 2.5V6A, 5V3A.	7/6
T164919-10V4A Primary Tapped 110-250 v.	5/6
T1113AB-110/230 v. 500 watt Auto Transformer	29/6

The following chokes are interleaved and impregnated.
T7907-250 m/A., 135 ohms, 20-8 Hy., cadmium shrouded. 12/6
T7907A-150 m/A., 250 ohms, 30-12 Hy., cadmium shrouded. 12/6
100 m/A., 20 Hy., 500 ohms, unshrouded. 4/11
60 m/A., 15 Hy., 250 ohms. 1/11
HEAVY DUTY TRANSFORMER for models, bels, etc., 6 v. 3 a., 2/3
4 mf., 1,500 v. test 500 v. wkg. oil filled condensers, 2/-
HEAVY DUTY Mains Transformer, worth 45/-, 350-350, 150 m/A.
4 v. 2.5 a. CT, 4 v. 6a. CT, 12/6; 300-300 v., 80 m/A., 4 v. 3 a.
CT, 4 v. 2 a., CT, 6/8. Moving Coil Speaker Transformers, power, pentode or push pull, 1/11. WB Heavy duty ditto, 2/11.

GANG CONDENSERS with Airplane Dial, 8 and 80-1. Cost 35/-. Few only. 4/11. Utility, 7/6. Microdials, 3/9.

W.B. Sin. PERMANENT MAGNET SPEAKERS AT ONE-THIRD COST
Extension Type (no Transformer), 8/11. Standard Type (with Transformer) 10/6. Energised 8", 1200 ohms with Transformer, 5/11.

PUSHBACK Wire, 6 yds. 6d., heavy 9d. Resin-cored Solder, 6ft. 6d.; Screened Flex, single, 6d. yd.; twin, 9d. yd. Assorted Solder Tags, 6d. packet. Humdimers 6d. each. Centralab pots, all sizes, 1/6; switched, 2/-; tubular fuses, 2d. Millimeters, 25 m.a., upwards 5/9.

VALVES: Reliable replacements for all types, British and American, showing saving of over 50 per cent.

OUR NEW 66-PAGE MANUAL, packed full of valuable information. Communication receivers, transmitters, etc., 71d. post free.

THE NEW RAYMART CATALOGUE shows dozens of New Short-wave Components and is yours for 1d. post free. *TRADE ENQUIRIES solicited for all types of communication equipment, transmitters, receivers, etc.*

RADIOMART Telephone: MIDland 3254.
G.S.N.I. (Birmingham) Ltd.
44, HOLLOWAY HEAD, BIRMINGHAM

We do quite a lot of business making up transformers to customers own



specifications; but we have a standard list. May we send you a copy?

W. BRYAN SAVAGE LTD

Westmoreland Rd., London, S.W.9. Phone: Colindale 7131

Mention of "The Wireless World," when writing to advertisers, will ensure prompt attention.

BULGIN

RADIO COMPONENTS

NATIONAL EMERGENCY

SUBJECT to our ability to obtain raw materials and meet restrictions which may be imposed, we will endeavour to maintain supplies of all our products. We feel sure that our many trade friends will appreciate that certain difficulties will arise, and we must, therefore, reserve the right to modify prices, if necessary, by any excess amount which we may have to pay for raw materials and for labour used.

Will you please continue to order your requirements as heretofore and they will receive our best attention.

Specified this week: 1 each List Nos. V.C.80, S.202, L.F.62, L.F.64 (in stock) for "Headphone Listening."

----- Send Coupon NOW -----

Please send me the NEW 128 pp. Catalogue No. 162, showing full range of Bulgin Products.

NAME

ADDRESS

W.T.28.9.39

Advt. of A. F. BULGIN & Co., Ltd., ABBEY ROAD, BARKING, ESSEX. Tel.: RIPpleway 3474 (3 lines)

CLASSIFIED ADVERTISEMENTS

NOTICES

THE CHARGE FOR ADVERTISEMENTS in these columns is

12 words or less, 3/- and 3d. for every additional word.

Each paragraph is charged separately and name and address must be counted.

SERIES DISCOUNTS are allowed to Trade Advertisers as follows on orders for consecutive insertions, provided a contract is placed in advance, and in the absence of fresh instructions the entire "copy" is repeated from the previous issue: 13 consecutive insertions 5%, 26 consecutive, 10%; 52 consecutive, 15%.

ADVERTISEMENTS for these columns are accepted up to FIRST POST ON MONDAY MORNING (previous to date of issue) at the Head Offices of "The Wireless World," Dorset House, Stamford Street, London, S.E.1, or on SATURDAY MORNING at the Branch Offices, 8-10, Corporation Street, Coventry; Guildhall Buildings, Navigation Street, Birmingham, 2; 260, Deansgate, Manchester, 3; 26a, Renfield Street, Glasgow, C.2.

Advertisements that arrive too late for a particular issue will automatically be inserted in the following issue unless accompanied by instructions to the contrary. All advertisements in this section must be strictly prepaid.

The proprietors retain the right to refuse or withdraw advertisements at their discretion.

Postal Orders and Cheques sent in payment for advertisements should be made payable to LILFEE & SONS Ltd., and crossed & Co. Notes being untraceable if lost in transit should not be sent as remittances.

All letters relating to advertisements should quote the number which is printed at the end of each advertisement and the date of the issue in which it appeared.

The proprietors are not responsible for clerical or printers' errors, although every care is taken to avoid mistakes.

NUMBERED ADDRESSES

For the convenience of private advertisers, letters may be addressed to numbers at "The Wireless World" Office. When this is desired, the sum of 6d. to defray the cost of registration and to cover postage on replies must be added to the advertisement charge, which must include the words Box 000, c/o "The Wireless World." All replies should be addressed to the Box number shown in the advertisement, c/o "The Wireless World," Dorset House, Stamford Street, London, S.E.1. Readers who reply to Box No. advertisements are warned against sending remittances through the post except in registered envelopes: in all such cases the use of the Deposit System is recommended, and the envelope should be clearly marked "Deposit Department."

DEPOSIT SYSTEM

Readers who hesitate to send money to advertisers in these columns may deal in perfect safety by availing themselves of our Deposit System. If the money be deposited with "The Wireless World," both parties are advised of its receipt.

The time allowed for decision is three days, counting from receipt of goods, after which period, if buyer decides not to retain goods, they must be returned to sender. If a sale is effected, buyer instructs us to remit amount to seller, but if not, seller instructs us to return amount to depositor. Carriage is paid by the buyer, but in the event of no sale, and subject to there being no different arrangement between buyer and seller, each pays carriage one way. The seller takes the risk of loss or damage in transit, for which we take no responsibility. For all transactions up to £10, a deposit fee of 1/- is charged; on transactions over £10 and under £50, the fee is 2/6; over £50, 5/-. All deposit matters are dealt with at Dorset House, Stamford Street, London, S.E.1, and cheques and money orders should be made payable to Lilfee & Sons Limited.

SPECIAL NOTE.—Readers who reply to advertisements and receive no answer to their enquiries are requested to regard the silence as an indication that the goods advertised have already been disposed of. Advertisers often receive so many enquiries that it is quite impossible to reply to each one by post. When sending remittances direct to an advertiser, stamp for return should also be included for use in the event of the application proving unsuccessful.

ARMSTRONG

ANNOUNCE

that in accordance with their well-known Fair Trading Policy, there will be

NO INCREASE IN PRICES

on their existing stocks of Chassis.

We can give immediate delivery of all Chassis described in our 1940 Catalogue, except Model SS2B.

Send for our Illustrated Art Catalogue which fully describes our full range, including the following:

MODEL AW38—8-V ALL-WAVE SUPERHET

This radiogram chassis has R.C. Coupled Push-Pull Output capable of handling 6 watts.

This being our Quality Year we have carefully studied the design of our more economically priced models and it's now possible for those requiring 8 gns. quality with economy to satisfy their desire.

MODEL AW93PP—9-V ALL WAVE SUPERHET

A radiogram chassis with 3 wavebands, R.F. Pre-Amplifier, 3 stages of A.V.C. and 8 watts R.C. coupled Triode P.P. output 10 gns.

MODEL SS10 — 10-V SUPERHET - STRAIGHT ALL-WAVE HIGH-FIDELITY R-G CHASSIS

Incorporating Two Independent Circuits, Superheterodyne and Straight, having R.F. Pre-Amplifier and R.C. Coupled Push-Pull Triode Output capable of handling 8 watts 12 gns.

MODEL AW125PP—12-V 5-BAND ALL-WAVE R-G CHASSIS (12-550 continuous, 1000-2000 m)

with R.F. Pre-Amplifier, 2 I.F. stages with Variable Selectivity, Manual R.F. gain control and 10 watts R.C. Coupled Triode P.P. Output.

Readers need no introduction to this most popular model, so favourably reviewed by *The Wireless World* on Jan. 5th last. Basically, it remains the same but the frequency response has been still further improved to conform to the higher standard of quality we have set ourselves this year. 17 gns

7 DAYS' APPROVAL—12 MONTHS' GUARANTEE

ARMSTRONG MANUFACTURING CO. WARTLERS ROAD, HOLLOWAY, LONDON, N.7 (Adjoining Holloway Arcade.) Phone: NORth 3213

L-R-S

intend carrying on the good work of supplying Quality Radio Equipment.

ARMSTRONG CHASSIS

PORTABLE A.R.P. RECEIVERS and other reliable radio apparatus are available as usual on our very CONVENIENT TERMS. Write for quotation and full details.

—PLEASE NOTE OUR TEMPORARY ADDRESS—

LONDON RADIO SUPPLY COMPANY

"DENWYN," OXENDEN WOOD RD., CHELSFIELD, KENT

ENGINEERS! ARE YOU EARNING LESS THAN £10 PER WEEK?

If so, you cannot afford to carry on without reading our 268-page Handbook. The book explains clearly and definitely many ways of carving out a successful career. Among other things it explains the Services of our unique Appointments Department: outlines Home-Study Courses in all branches of Civil, Mechanical, Electrical, Motor, Aero, Wireless, "Talkie" Engineering, Building, Govt. Employment, etc., and gives details of B.Sc., A.M.I.C.E., A.M.I.E.E., A.M.I.Mech.E., A.M.I.A.E., A.M.I.W.T., A.M.I.R.E., G.P.O., MATRIC., and all Exams. We Guarantee — "NO PASS—NO FEE." Whether you be an old hand or a budding apprentice get this book to-day. FREE and POST FREE.



BRITISH INSTITUTE OF ENGINEERING TECHNOLOGY, 367, Shakespeare House, 17/19, Stratford Place, London, W.1.

NEW RECEIVERS AND AMPLIFIERS

* CHALLENGER Range for 1940.

CHALLENGER RADIO CORPORATION.—2d. stamp for illustrated catalogues of battery, battery-mains, car radio, and mains receivers; 63/- to £28; sale list also available.

CHALLENGER RADIO CORPORATION, 31, Craven Terrace, London, W.2. Nearest point, Lancaster Gate Station. [8872]

RADIO CLEARANCE, Ltd., 63, High Holborn, W.C.1. Telephone: Holborn 4631.

BRITISH Belmont 8-valve plus Magic Eye All-wave A.C. Superhet Chassis, 4 wavebands, two short, medium and long, fitted latest Millard octal base American type valves, size of chassis 13 1/2 in. x 10 in. x 3 1/2 in., supplied with valves, escutcheon and knobs, but less speaker; chassis only, £5/19/6 each; speaker for above, 17/6 each.

LISSEN 4-valve A.C. Superhet, two wavebands, medium and long, complete with valves; limited number available; £4/4 each.

RADIO CLEARANCE, Ltd., 63, High Holborn, W.C.1. Holborn 4631. [8907]

PUBLIC ADDRESS

VORTEXION P.A. Equipment.

IMITATED, but unequalled.

WE Invite you to a Demonstration.

A.C.-D.C. Dance Band Amplifier, 10 watts output, complete in case, with moving coil microphone, speaker and cables, weight 22lb.; 12 gns.

A.C.-20 15-20-watt Amplifier, 38-18,000 cycles, independent mike and gram, inputs and controls, 0.037 volts required to full load, output for 4, 7.5, and 15 ohms speakers, or to specification, inaudible hum level, ready for use; 8 1/2 gns. complete.

C.P. 20 12-volt Battery and A.C. Mains Model, as used by R.A.F., output as above; 12 gns.

A.C.-20, in portable case, with Collard motor, Piezo pick-up, etc., £14; C.P. 20 ditto, £17/17.

50-WATT Output 6L6s, under 60-watt conditions, with negative feed back, separate rectifiers for anode screen and bias, with better than 4% regulation level response, 20-25,000 cycles, excellent driver, driver transformer, and output transformer matching 2-30 ohms impedance electronic mixing for mike and pick-up, with tone control, complete with valve and plugs; £15.

COMPLETE in Case, with turntable, B.T.H., Piezo pick-up and shielded microphone transformer; £20.

80-WATT Model, with negative feed back; £25, complete.

120-WATT Model, with negative feed back; £40, complete.

250-VOLT 250 m.a. Full Wave Speaker field supply unit; 25/-, with valve.

ALL P.A. Accessories in Stock; trade supplied.

VORTEXION, Ltd. 182, The Broadway, Wimbledon, S.W.19. Phone: Lib. 2814. [8241]

PUBLIC ADDRESS

TANNOY 25-watt Amplifier, Ad-on-Unit, A.C. mains, complete; £10.—Easco, 18w, Brixton Rd., S.W.9. [0643]

W.W. Contrast Amplifier, professionally assembled, unused, guaranteed; 50/-.—Brewer, Bethcar St., Ebbw Vale. [8899]

"PARTRIDGE P.A. Manual," standard handbook on electro-acoustics, amplifiers, and audio circuits; price 2/6 (free to trade).

"PARTRIDGE Amplifier Circuits," describes many modern constructional amplifiers, 2w. to 45w. output, battery, A.C.-D.C., etc.; price 2/- (no free copies).

PARTRIDGE, N., B.Sc., A.M.I.E.E., King's Buildings, Dean Stanley St., London, S.W.1. [0630]

PUBLIC Address Contractors Can Hire P.A. Vans, loud speakers, microphones and equipments of all types from Hire Dept., Gramphon Reproducers, Ltd., Kew Gardens, Surrey. Tel.: Richmond 1175-6-7. [0618]

NEW LOUD-SPEAKERS

BAKERS New Corner Horn Speakers, triple cone versions; from 29/6, and surplus speaker bargains.—Bakers Selhurst Radio, 75, Sussex Rd., South Croydon. [8728]

LOUD-SPEAKERS

SECOND-HAND, CLEARANCE, SURPLUS, ETC.

VOIGT Corner Horn, cement lined base chamber, £12/10; 15in. A.C. Baker auditorium, £4; Watson mercury vapour lamp, D.C., £2/10.—Box 983, c/o The Wireless World. [8902]

Wanted

WANTED, two Celestion 48 Auditorium, or Magnavox 66 speakers.—Johnson, Claylake, Endon, Stoke-on-Trent. [8900]

TRANSMITTING APPARATUS

G5NI for Communication Receivers, American and British valves, short-wave equipment; largest stocks in the country; National Agents.—44, Holloway Head, Birmingham. [0531]

CABINETS

A CABINET for Every Radio Purpose. CONVERT Your Set into a Radiogram at Minimum Cost; surplus cabinets from noted makers under cost of manufacture (undrilled); 30/- upwards; motors at wholesale prices.

"FUT-A-GRAM" Cabinet, 31x17x15, 21/-.

UNDRILLED Table Console and Loud-speaker Cabinets from 3/6.

INSPECTION Invited; photos loaned to country customers.

H. L. SMITH and Co., Ltd., 289, Edgware Rd., W.2. Tel.: Pad. 5891. [0485]

COMPONENTS—SECOND-HAND CLEARANCE, SURPLUS, ETC.

RADIO CLEARANCE, Ltd., 63, High Holborn, W.C.1. 'Phone: Holborn 4631. CO-AXIAL Cable, finest quality, for television lead in, heavy vulcanised tough rubber insulated closely meshed screen; single, 6d. per yard; twin, 9d. per yard. FILAMENT Transformers, input 200-250 volts, output 4 volts 4 amps., 4 volts 6 amps.; 4/11 each. MAINS Transformers, American windings, input 200-250 volts, tapped, output 250-0-350 100 m.a., 5 volts 2 amp., 6.3 volts 5 amp.; 8/6 each. G.E.C. Mains Transformers, American windings, 350-0-350 volt 65 m.a., 5 volt 2 amp., 6.3 volt 2.5 amps., suitable for replacements in G.E.C. models, 5/6 each; auto transformers, 100-230 volt, 6/3 each. ELECTROLYTIC Condensers, Plessey 8x4x4x4 mid., 570 volt working; 2/- each. 24 Mid. Can Type Electrolytics, 450 volt working, 1/6 each; T.C.C. 8 mid. can type, wet electrolytics, 450 volt working, 1/3 each. POLAR N.S.F. Resistances, 1 gross parcels of 1/2 and 3/8 watt resistances, all good sizes, our selection; 5/- gross. PRESS-BUTTON Units, with 6 press buttons, ready for wiring into set, with circuit; 6/11 each. BULGIN 20 ohms Wire-wound Pots, 1/- each; stranded push-back wire, 1d. per yard, 12 yards 10d. YAXLEY Switches, 2 pole, 4 way, 3 bank, 2/- each; 2 pole, 5 way, 4 bank, 2/6 each; 2 pole, 6 way, single bank, 1/6 each. CHASSIS Mounting Valve Holders, American, 4, 5, 6 and 7 pin, 4d. each; Octal, 5d. each; Loctal, 10d. each; 7 pin English type, 3d. each. ROTHERMEL Piezo Crystal Speakers, 7/16 in. cone, list 55/-; our price 10/6 each. G.E.C. Relays, make and break type, 3,300 ohms, 4/- each. CRYSTAL Pick-up, high grade American, bronze finish, complete with arm; £1/5 each. POLAR N.S.F. 1-watt Resistances, 4d. each, 3/9 per doz.; all sizes up to 2 meg. MAINS Smoothing Chokes.—Wearite unshrouded, fitted wire ends; 30 henry, 80 m.a., 500 ohms, 2/6 each; 40 henry, 150 m.a., 500 ohms, 1/6 each. WEARITE Mains Transformers, made to strict electrical standards, wire-end type, all windings centre tapped, screened primaries, tapped inputs, 200-250 volts, screw adjustment. TYPE R.C.2, 350-0-350 120 m.a., 4 volts, 2.5 amp., 4 volts, 5 amp., 11/- each. TYPE R.C.3 350-0-350, 150 m.a., 4 volts, 2.5 amp., 4 volts 2 amp., 4 volts 5 amp., 12/6 each. TYPE R.C.4, 500-0-500, 150 m.a., 4 volts 2 amp., 4 volts 2 amp., 4 volts 2.5 amp., 4 volts 5 amp., 19/6 each. R.C.2 Drop-through Type, capped; R.C.3 and R.C.4 upright mounting type, fully shrouded. AMERICAN C.T.S. Volume Controls, finest made, divided spindles, length 2 1/2 in., with switch, 2,000, 5,000, 10,000, 25,000, 50,000, 100,000, 2/6 each; less switch, 50,000, 100,000, 500,000, 1/9 each; wire-wound, 5-watt (less switch), 2,000, 10,000, 25,000, 50,000, 2/- each. BRADLEY Ohm Wire-wound Volume Controls, with switch, 600,000 ohms, 1/- each. PILOT Bulbs, 6.3 volts, 0.3 amp., 3d. each. WEARITE H.F. Chokes, 1/6 each. PENTODE Speech Transformers, 2/- each. T.C.C. Cardboard Electrolytics, wire-end type, 500 volt wkg., 600 volt surge, 8 mid. type "Minor," 2/- each. 8x8 4-wire Type "Minor," 3/- each; 8mid. midget tubular wire end, 500 volt working, 600 volt surge, 2/- each; bias wire-end type, 25 mid., 25 volt, 1/6 each. 50 mid., 12 volt, 1/3 each; 50 mid., 25 volt, 1/9 each. 25 mid., 25 volt, 1/6 each; tubular, wire-end non-inductive paper, all sizes up to 0.1, 5d. each, 4/9 per doz. METAL Case, 1 hole fixing, electrolytic condensers, 500 volt working, 600 volt surge, 8 mid.; 2/6 each. STANDARD Telephone Headphones, resistance 2,000 and 4,000 ohms; 6/11 per pair. VOLUME Controls, 1,000 and 5,000 ohms only, with switch; 1/3 each. 0005 3-gang Tuning Condenser Units, with trimmers, 2/11 each. CELESTION 10in. P.M. Moving Coil Speakers; 15/6 each. MAGNAVOX Energised Speakers, 450 ohms field, 10 watts output, less transformer, 10in. cone; super bargain at 17/6 each. RUBBER Grommets, 4d. per doz.; special offer Raytheon No. 76 valves, 2/- each. METAL Face Ply., approximately 16in.x10in.; 1/3 each. S.P.D.T. Twist Switches, 1/1 each; D.P.D.T. twist switches, 1/3 each. RAYTHEON First-grade Valves, largest stockists, all types in stock, including Glass Series, Glass Octal Series, Metal Series, Bantam Series, Single-ended Metal Series, and Resistance Tubes; all at most competitive prices; send for lists. ALL Orders Must Include Sufficient Postage to Cover; A hours of business, 9 a.m.-6 p.m., Saturdays 9 a.m.-1 p.m. RADIO CLEARANCE, Ltd., 63, High Holborn, London, W.C.1. Telephone: Holborn 4631. [8906

COMPONENTS—SECOND-HAND CLEARANCE, SURPLUS, ETC.

SOUTHERN RADIO'S Bargains. ALL Articles Fully Guaranteed. Postage extra. 5/-—Parcel of useful components, comprising condensers, resistances, volume controls, coils, wire, circuits, etc., etc., value 25/-, 5/- per parcel. 10/-—Parcel of useful components, comprising 100 articles, including electrolytics, valve holders, etc., etc., value 55/-, 10/- per parcel. 21/-—Small traders' parcel of components, comprising at least 150 articles, including 24 assorted tubular condensers, 24 valve holders, 36 resistances, 12 Mainsbridge type condensers, 6 electrolytics, etc., etc., value 85/-, 21/- per parcel. 5/-—Twelve Mainsbridge type condensers, 1-2-4 mid.; 5/- per dozen. 7/6—24 assorted tubular condensers, up to 2 mid., 7/6 for 24; Delson 3-range meters (volts and milliamps), 4/-; Morse tappers, 2/11. BZZERS, 1/6; crystal detectors, 2/-; crystal sets, 5/6; B crystals, 6d. 2/6—Ormond loud speaker units, 2/6; A.C. eliminators, with trickle charger, 3/7.6. IN Spite of Increased Costs of Production, whilst our present stock lasts no increase will be made in prices. It is, however, advisable to buy now. Thousands of bargains for callers. SOUTHERN RADIO, 46, Lisle St., London, W.C. Ger-rard 6653. OLIVERS Offer Aluminium Chassis, 16in.x10in.x3in., 18 swg., undrilled, 7/6; full range of components held; lists—Olivers, 676, Christchurch Rd., Boscombe, Hants. [8901] MAINS RADIO DEVELOPMENT COMPANY Continue their Super Service Under Management of Proprietor's wife; stamp for list 230; note new address, 52a, Church Crescent, Muswell Hill, N.10. ERIE Unused Resistors, 1-watt, all sizes, 3d. each. 2/6 dozen; 2-watt, 6d. CENTRALAB Latest Long Spindle Potentiometers, all sizes, 2/-; with switch, 2/3. TUBULAR Condensers, new, 400v.w., non-inductive, best make, all sizes to 0.1 mid.; 4d. FIFTY Wire-end N.S.F. Resistors, grand assortment, 2/6; Chix valve-holders, 5, 7-pin, 3d. [8893]

REPAIRS AND SERVICE

LOUD-SPEAKER Repairs, British, American, any make, 24-hour service; moderate prices—Sinclair Speakers, Pultney Terrace, Copenhagen St., N.1. [0530] GUARANTEED Repairs, Any Transformers, choke, motor armature, converter, dynamo, etc., keenest prices, immediate quotation, prompt, dependable service.—See below. L.T.E. (LONDON TRANSFORMER PRODUCTS, Ltd.), 1 Willesden, N.W.10. Willesden 6486 (3 lines). [6892] MAINS Transformer Service, Repairs, rewinds, or construction to specification of any type, competitive prices and prompt service.—Sturdy Electric Co., Dip-ton, Newcastle-on-Tyne. [0516] METROPOLITAN RADIO SERVICE.—Guaranteed repairs to American and British receivers; American valves, service parts and rewinds; trade supplied.—1021, Finchley Rd., N.W.1. Speedwell 3000. [0435] REPAIRS to Moving Coil Speakers a Speciality; cones and coils fitted, fields altered; prices, including eliminators, quoted; loud speakers, 4/-; L.F. and output transformers, 4/-, post free, guaranteed satisfaction; trade invited, estimates free; prompt service.—Loud Speaker Repair Works, 5, Balham Grove, London, Battersea 1321. [0394]

SITUATIONS VACANT

AIR MINISTRY. AERONAUTICAL Inspection Directorate. VACANCIES Exist for Unestablished Appointments as Examiners in the W/T and Instrument Branches. QUALIFICATIONS. ALL Candidates Must Have Had Good General Education, be able to read drawings, understand specifications, use micrometers and other measuring instruments. APPLICANTS for the Instrument Branch Must Have Knowledge of Physics and Training in Light Engineering or Instrument Making. Candidates with knowledge of optical instruments are also required. APPLICANTS for the W/T Branch Must Have Practical Knowledge of W/T and Electrical Equipment, with technical training in radio communication equal to City and Guilds final examination standard. APPLICATION from Candidates Previously Declared Unsuccessful will be Considered provided the necessary additional experience has been gained. ACCEPTED Candidates Will Undergo a Period of Training in Inspection as Applied to the Above Subjects, not exceeding three months, and will be paid £3/10 weekly during training. Subsistence allowance of £1/5 weekly during training is payable to married men normally residing outside the training area. On successful completion of training, candidates will be appointed as Examiners at a salary of £246 a year (payable monthly in arrears) if service is satisfactory, and must be prepared to serve in any part of the United Kingdom and to fly as observers in connection with their duties. NORMAL Age Limits, 21 to 55. A reduction of £12 p.a. from the Examiner scale will be made for each year below age 24. APPLICATION Must be Made on Form 786, copies of which can be obtained on application, by post-card only, to:— THE Under Secretary of State, Air Ministry (ICS/REC/47), Harrogate. [8903] RADIO Service Engineer, permanent job right man.—Hammonds, 23, Bell St., Henley-on-Thames. 'Phone: 220. [8898]

MISCELLANEOUS

EVERY Radio Dealer Who is Not a Regular Reader of "The Wireless and Electrical Trader" should send his trade card at once for a specimen copy and full details of the "Trader" Services. "The Wireless and Electrical Trader" has the widest influence, the largest weekly circulation, and is read by all the leading manufacturers and traders. Trade only. 15/- per annum, post free.—Published at Dorset House, Stamford St., London, S.E.1. [0615] BEST Wartime Training in Engineering is Home Study with the T.I.G.B., which the black-out and restricted travelling do not affect. Trained men are urgently required for well-paid technical posts in all Branches and in the Services. Write to-day for "The Engineer's Guide to Success"—free—containing world's widest choice of engineering courses—over 200—covering all branches, and which shows how to qualify for A.M.I.Mech.E., A.M.I.E.E., A.F.R.Ac.S., C. & G., Air Ministry Licences, etc. The T.I.G.B. guarantees training until successful. THE TECHNOLOGICAL INSTITUTE OF GREAT BRITAIN, 82, Temple Bar House, Fleet St., E.C.4. (Founded 1917. 20,000 successes.) [8874]

PATENT AND TRADE MARK AGENTS

GEE and Co. (H. T. P. Gee, Mem. R.S.G.B., etc.), 51-52, Chancery Lane, London, W.C.2. Holborn 4547-8. Handbook free. [0001]

TUITION

RADIO Training.—P.M.G. exams and I.E.E. Diploma; prospectus free.—Technical College, Hull. [0611] PRACTICAL Postal courses, radio television; test equipment design; I.P.R.E. and I.W.T. exams.—Write I.P.E., 3, Shirley Rd., London, W.4. [8838]

BUSINESSES AND PROPERTY FOR SALE, TO BE LET, OR WANTED

"THE Wireless and Electrical Trader" is an essential part of the equipment of every Wireless Trader; its pages reflect the very latest turn of trade events, and it is read by all the leading dealers and manufacturers, for particulars of businesses offered or wanted. By subscription to the trade only, 15/- per annum, post free.—Send your trade card for specimen copy to Dorset House, Stamford St., London, S.E.1. [0614]

ELECTRADIX

At a time like this we are only advertising immediately useful items. Previous adverts. detailed a wide range of goods. Where stock is limited preference is now given to National Service users.

ELECTRIC SUPPLY. An Independent Emergency or Stand-by set may be of great value to you. Can be transported on any car that can carry 3 cwt. All these sets that we are offering are in first-class order and straight from reserve Govt. Stores, kept unused as stand-by. Being a pre-crisis release they are an opportunity for a low price purchase that might not otherwise have occurred and certainly cannot be repeated. The Half Kilowatt Set is worth £50, but our price is only £16, and with engine and dynamo carry the full Electradix guarantee.

A.R.P. PETROL ELECTRIC GENERATING SETS for Lighting and Charging. Half h.p. DIRECT COUPLED 150 watts - D.C., 1,900 r.p.m., 2-stroke water-cooled 1-cyl. Engine, magneto ignition. On besplate with 30 volts 5 amps. Dynamo, £12. 90 larger size 1 kW. S.T. Petrol Electric Sets, 500 watts, 2-stroke water-cooled 1 h.p. 1-cyl. engine on besplate, direct coupled to 50/70 volts 19 amps. D.C. Dynamo, magneto ignition, fuel and oil tank, £16.

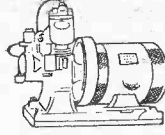

STORAGE. You may have charging facilities and want to install high capacity steel accumulators which will hold their charge almost indefinitely. A.R.P. EDISON HIGH CAPACITY STEEL CELLS at half price for stand-by lighting, 120 A.H. to 300 A.H. at 20/- to 25/-. Makers' Price is 25s. Ask for leaflet. FULL PARTICULARS gladly given as far as we are able to A.R.P. ENQUIRERS.

YOU MUST KEEP YOUR BATTERY PREPARED !!! Battery Charging on A.C. Mains. The A.C. NITN-DAY will keep your battery fit without attention. Model N/A6, 100/250 volts A.C. and D.C. 6/8 volts 1 amp., 15/-; Model N/B6, 100/250 volts to D.C. 6/8 volts 1 amp., 25/-. Model N/C6, 100/250 volts to D.C., 6/8 volts 2 amp., 35/-. Model N/D12, 100/250 volts to 12 volts 1 amp., 32/-. Ditto, 12 volts 2 amps., with 6-volt tap, 55/- 5 amp., £41/10.

Fuggy Dugouts or ill-ventilated shelters must be kept fresh. A.R.P. SHELTER Ventilation and Air Conditioning. Compact unit, drive off A.C. or D.C. mains, 30 watts; 9in. Blower, 20 cub. ft. fresh air per min., 25/- is a bargain price. WET WEATHER ELECTRIC PUMPS, for A.C. or D.C. 12 v. to 230 v. Centrifugal all-bronze pump, throws 120 gals. per hour, 72/6. Type R pumps. Twin piston type for draining shelters, dug-outs, etc., £5/17/6. RADIO SIGNAL PHONES. Complete sets with 5 line or 20 line exchanges. Portable army wardens phones, etc. State war.

POCKET HEADPHONES, W.D., all leather headband strap and cords, 2/6 pair. Wireless type, with aluminium headbands, 2/9. 4,000 ohms, 4/6. LISTENING MIKES steel-clad Electradix indestructible; are ears outside your dug-out.

CABLE. Lightweight twin field cable, unbreakable Army steel reinforced, 55-mils. Heavier types, 65 and 70. FIRE CONTROL SIGNALS. Emergency day Lucas and Aldis Hooded Army Signal Lamps, telescopic sights, hand or tripod. For Fire Brigades and Police, 60/-. AIR RAID SIGNAL BELLS—FIRE ALARM BELLS. Waterproof mains, Battery or Hand magneto Buzzers; Morse Practice Sets. Morse Keys. Recorder gear, as previous adverts.

5/- EMERGENCY PARCELS of useful stand-by electrical and radio repair material and apparatus, 10lbs. for 5/-. Post Free.

Don't forget to send now for our Bargain List "W." ELECTRADIX RADIOS 218, UPPER THAMES STREET, LONDON, E.C.4 Telephone: Central 4611

THE INSTITUTE OF WIRELESS TECHNOLOGY (Founded in 1925. Incorporated). PROFESSIONAL MEMBERSHIP The advantages of professional membership are open to all qualified wireless engineers. Full information, with syllabus, may be obtained from the Assistant Secretary, Institute of Wireless Technology, 25, First Drive, Palmers Green, London, N.13.

Sixth Edition

Revised and Enlarged

HANDBOOK of TECHNICAL INSTRUCTION for WIRELESS TELEGRAPHISTS

by H. M. DOWSETT
(M.I.E.E., F.Inst.P., M.Inst.R.E.)

This standard handbook is planned primarily for the use of wireless operators, whether prospective or actual. It is virtually a complete theoretical course for students wishing to qualify for the Postmaster-General's Certificate of Proficiency.

CONTENTS INCLUDE:

The Electric Charge and the Condenser—The Condenser in Practice—Direct Current and Ohm's Law—Scalar and Vector Quantities and Curve Plotting—Primary Batteries—Accumulators—Magnetism—Electro Magnetism—Self-Induction—Dynamo Electric Machines—Measuring Instruments—Switchboards and Switchgear—Alternating Current Effects, and Vector Diagrams—Alternating Current Fundamental Formulae—Alternating Current Generators, Alternating Current Motors and Transformers—Damped Oscillations—Commercial Types of Spark Transmitter—Aerials and Radiation—Simple Receiver Circuit and Crystal Detector—Thermionics and the Various Applications of the Valve—Depth Sounding—Valve Transmitters—Wavemeter and Transmitter Adjustment—Theory of Valve Receiver Circuits—Valve Receivers—Short Wave Aerials and Apparatus—Marine Direction Finders—Marine Audio Relay Service—Distress Call Apparatus—Lifeboat and Emergency Outfits—Trawler Apparatus—Maintenance of Marine Radio Installations and Possible Faults.

PRICE 21/- By post 21/9
By Foreign Post 22/-

Obtainable from leading booksellers or direct from the Publishers:

ILIFFE & SONS LTD., DORSET HOUSE, STAMFORD STREET, LONDON, S.E.1

FOUNDATIONS of WIRELESS

—SECOND EDITION

By A. L. M. SOWERBY, M.Sc.

An Elementary Text Book on Wireless Receivers

*A Book of
First Principles for
the
Wireless Enthusiast*

PRICE 4/6 NET

By Post 4/11

Issued in conjunction with
"THE WIRELESS WORLD"
and published by the proprietors—

"Foundations of Wireless," based on a series of articles which appeared in "The Wireless World," covers the whole field of wireless from the simplest electrical phenomena to the construction of a modern set, and all the vital points in receiver design are treated in full detail. Chapters are devoted to direct and alternating currents; typical circuits; the properties of inductance and capacity; the nature of high frequency currents; the tuned circuit; and amplification by the valve.

Eleven of the eighteen chapters of the book deal with the discussion of receivers, in which the whole process of design is reviewed stage by stage to the finished article. Special attention is paid to the important subject of tuned circuits and band-pass filters, on the correct design of which the performance of every type of set ultimately depends. Moreover, the process of detection, so often imperfectly understood, is clearly explained.

ILIFFE & SONS LTD., DORSET HOUSE, STAMFORD STREET, LONDON, S.E.1

Mention of "The Wireless World," when writing to advertisers, will ensure prompt attention.

1 TRADE DEVELOPMENT AND PROGRESS

2 FACTS OF PRODUCTION AND DISTRIBUTION

TRADE & TECHNICAL JOURNALS

3 INFLUENTIAL AND AUTHORITATIVE

4 BUYERS REFERENCE

If you are seeking new markets, or desire to get first-hand information about a trade or industry, you cannot go to a more reliable or authoritative source than the trade and technical journals serving it. The address of any paper in this list will be furnished on request.

Architect and Building News.
 Architects' Journal.
 Architectural Review.
 Autocar.
 Automobile Engineer.
 Baths and Bath Engineering.
 Bicycling News.
 Boxmakers' Journal and Packaging Review.
 Brewers' Journal.
 British Baker.
 British Engineers' Export Journal.
 British Journal of Photography.
 Bus and Coach.
 Caterer and Hotel Keeper.
 Chemist and Druggist.
 Cigar and Tobacco World.
 Colliery Guardian.
 Confectionery Journal.
 Confectionery News and Ice Cream and Soda Fountain Journal.
 Contractors' Record and Municipal Engineering.
 Dairyman.
 Drapers' Organiser.
 Drapers' Record.
 Dyer.
 Electrical Engineer.
 Electrical Review.
 Electrical Times.
 Electrical Trading and Electricity.
 Engineer.
 Engineering.
 Export Trader.
 Footwear Organiser.

Furnishing Trades' Organiser.
 Grocer and Oil Trade Review.
 Grocers' Gazette and Provision Trades' News.
 Grocery and Branch Store Management.
 Hairdresser and Beauty Trade.
 Hotel and Catering Management
 Hotel Review.
 India-Rubber Journal.
 Ironmonger.
 Journal of Decorative Art.
 Kinematograph Weekly.
 Laundry Journal.
 Laundry (The Power).
 Laundry Record.
 Licensing World.
 Locomotive, Railway Carriage and Wagon Review.
 Machinery.
 Meat-Trades' Journal.
 Mechanical World and Engineering Record.
 Men's Wear.
 Metallurgia.
 Mining Journal, Railway and Commercial Gazette.
 Model Engineer and Practical Electrician.
 Modern Transport.
 Motor Cycle.
 Motor Cycle and Cycle Trader.
 Motor News.
 Motor Trader.
 Motor Transport.

Motor World and Industrial Vehicle Review.
 Motorist.
 Nursing Mirror.
 Oil and Colour Trades Journal.
 Optician.
 Overseas Engineer.
 Photographic Dealer.
 Plumbing Trade Journal.
 Pottery Gazette and Glass Trade Review.
 Poultry.
 Printers', etc., Sales and Wants Advertiser.
 Retail Chemist.
 School and College Management.
 Silk Journal and Rayon World.
 Small Trader.
 Smallwares, Novelties and Dress Accessories.
 Specification.
 Statist.
 Style for Men.
 Textile Manufacturer.
 Textile Recorder.
 Tobacconist and Confectioner.
 Tourist.
 Waste Trade World.
 Watchmaker and Jeweller, Silversmith and Optician.
 Water and Water Engineering.
 Wine and Spirit Trade Review.
 Wireless and Electrical Trader.
 Wireless Engineer.
 Wireless Retailer and Broadcaster.
 Wireless World.

Official Handbook, giving particulars of over 500 papers, post free 1/-.

PERIODICAL, TRADE PRESS AND WEEKLY NEWSPAPER PROPRIETORS' ASSOCIATION, LTD.

Telephone:
 Central 2441.

6, Bouverie Street, London, E.C.4

Telegrams:
 Weneppa, Fleet, London.